

ASIC

**Association Scientifique
Internationale du Café**

9ème

**COLLOQUE SCIENTIFIQUE
INTERNATIONAL SUR LE CAFÉ**

9th

**INTERNATIONAL SCIENTIFIC
COLLOQUIUM ON COFFEE**

9.

**INTERNATIONALES
WISSENSCHAFTLICHES
KOLLOQUIUM ÜBER KAFFEE**

9º

**COLÓQUIO CIENTÍFICO
INTERNACIONAL SOBRE
EL CAFÉ**

Volume I

Londres 16-20 juin 1980

NEUVIÈME COLLOQUE SCIENTIFIQUE INTERNATIONAL SUR LE CAFÉ

Londres 16-20 juin 1980

Volume I

Liste des participants	6	— Chemische Kennzahlen zur ergänzenden Qualitätsbeurteilung von Roh- und Röst- kaffee, J. Wurziger, R. Drews, B. Suche	151
Séance inaugurale	15	— Caffeine methodology : semi-automatic method for the determination of caffeine in green and processed coffees, K. G. Sloman	159
— Présentations de MM.		— An attempt to localize caffeine in the cell by its washout kinetics, R. Pfrunder, H. Wanner, P. M. Frischknecht, T. W. Baumann	169
— E. Illy	16		
— R. Coste	17		
— A. F. Beltrão	19		
Communications		Chimie dans ses relations avec la technologie	
— La ciencia y la tecnologia para un país productor, M. Quijano Rico	23	— Transport maritime du café vert et conte- neurisation, F. Jouanjan	177
— New trends in the pharmacology of caf- feine, R. Paoletti, S. Cantaluppi	41	— Storage research on Kenya arabica coffee, H. Stirling	189
Analyse chimique et composition		— Instrumentation system for the analysis of coffee beans, W. S. Maughan, S. Milo, L. Roarzi	201
— Bildung von Aromastoffen durch Maillard- reaktion, R. Tressl	55	— Pattern recognition in sorting green coffee beans, S. Milo	211
— Modelluntersuchungen über die Aromabil- dung in Kaffee, G. Herrmann, W. Baltes	77	— Coffee sorting with UV excitation, H. J. Carter	219
— La chromatographie liquide haute perfor- mance appliquée à certains constituants spécifiques du café, H. R. Moll, G. A. Pictet	87	— Amélioration dans le traitement des récol- tes de café (application au café Arabusta), J.-C. Vincent, M. Jacquet	227
— Evidence for complex formation between thiamine and the chlorogenate ion in aqueous solution, I. Horman, R. A. Carpenter, E. Brambilla, B. Dreux	99	— The utility of chemical engineering princi- ples in coffee-processing technology, C. Judson King	237
— Analysis of chlorogenic acids in coffee, G. H. D. Van der Stegen, J. Van Duijn	107	— Flavour retention during freeze-drying of coffee, P. Fosbøl, E. E. Petersen	251
— Zur Bestimmung der Extraktionsausbeute von Kaffee-Extrakt, H. G. Maier	113	— Possible applications of enzymes in coffee processing, G. M. Ehlers	267
— Investigations of contaminants in coffee, C. P. Levi	125	— Consumer and expert evaluations of stored coffee products, W. P. Clinton	273
— Physical properties and behaviour of caf- feine and its aqueous solutions, H. Bothe, H. K. Cammenga	135	— Evaluation des qualités d'une tasse de café : effet de la température de l'eau d'extraction, A. Voilley, F. Sauvageot, P. Pierret	287
— Identifizierung und Quantifizierung eme- tisch wirksamer Bestandteile in Röstkaffee, W. A. König, W. Rahn, R. Vetter	145	— Decaffeination of coffee, S. N. Katz	295
		— Utilization of coffee pulp as animal feed, R. Bressani, J. E. Braham	303

— Microbiological methods for the disposal and utilisation of coffee processing wastes, M. R. Adams, J. Dougan	325
— Contribution à l'étude de la composition chimique de la pulpe de café, J. Zuluaga Vasco, R. Tabacchi	335
— Evolution d'un café Arabica torréfié stocké dans quatre emballages modèles. Analyses sensorielles. Evolution de la fraction volatile. Comparaison par rapport à un témoin. Limite d'utilisation optimale, E. Cros, G. Fourny, B. Guyot, M. Rouly, J.-C. Vincent	345

Effets physiologiques

— Possible interaction of coffee consumption with cardiovascular disturbances, L. Wilhelmsen, G. Tibblin, D. Elmfeldt, K. Svärdsudd, H. Wedel	353
— Coffee in health and disease. A critical review of the medical literature, S. Heyden	361
— Human metabolism of radiolabeled caffeine following oral administration, M. M. Callahan, R. Robertson, A. R. Branfman, M. McComish, D. W. Yesair	371
— Caffeine metabolism in human subjects, M. J. Arnaud, C. Welsch	385
— The influence of caffeine and coffee upon metabolic rate and substrate utilization in man, K. J. Acheson	397

LISTE DES PARTICIPANTS

Allemagne

- AUGSTEIN E.
BALTES W. - Institut Fresenius, Im Maisel 14, D-6204 Taunusstein-Neuhof
- Institut für Lebensmittelchemie, Technische Universität Berlin,
Müller-Breslau-Strasse 10, 1 Berlin 12
- BOTHE H. - Institut für Physicalische Chemie der technischen Universität,
Hans-Sommer Strasse 10, D-3300 Braunschweig
- CAMMENGA H. - Institut für Physicalische Chemie der technischen Universität,
Hans-Sommer Strasse 10, D-3300 Braunschweig
- DELIUS H. - Deutscher Kaffee-Verband e.V., Pickhuben 3, D-2000 Hamburg 11
DREWS R. - B. Rothfos, Kaffee-Import-und-Grosshandel, Sandtorkai 4-5,
D-2000 Hamburg 11
- PROWEIN J.
GALLWAS J.
GARLOFF H.
HAJDUGA D. - General Foods Ltd, Lornsenstrasse, D-2200 Elmshorn
- Coffein Co, Dr. Erich Schiele GmbH, Postfach 448130, D-2800 Bre-
men 44
- HEIDER H. - Unilever Forschungslabor
HERMANN G. - Institut für Lebensmittelchemie, Technische Universität Berlin,
Müller-Breslau-Strasse 10, 1 Berlin 12
- HOFMAN H.
KERBSTIES M. - Union Deutsche Lebensmittelwerke
- Tchibo, Frisch-Rost-Kaffee Aktiengesellschaft, Tchibo-Haus, Ober-
seering 18, D-2000 Hamburg
- KLUSTERS W.
KOEHLER T.
KONIG W.A. - General Foods GmbH, Lornsenstrasse, D-2200 Elmshorn
- DEK, Buschwerder, Hauptdeich 10, D-2000 Hamburg
- Institut für Organische Chemie und Biochemie, Universität Hamburg,
D-2100 Hamburg 13
- KRUGER W.
MAIER H. - General Foods GmbH, Lornsenstrasse, D-2200 Elmshorn
- Institut für Lebensmittelchemie der technischen Universität,
Fasanenstrasse 3, D-3300 Braunschweig
- MEISTER A.
MELCHERS G.
MENTHE J.
MEYER H.-V. - J. Jacobs GmbH, Langemarkt Strasse 4, D-2800 Bremen
- DECOFA, Hag Aktiengesellschaft, Hagstrasse, D-2800 Bremen
- Kaffee-Veredelungs-Werk, Postfach 460, 2 Hamburg 74
- Dr. Gilbert chemisches Laboratorium, Normannenweg 17-21, D-2000
Hamburg 26
- NEKOLA M.
RATHJEN B.
ROLLE D. - Nestle GmbH, Frankfurt
- HAG Aktiengesellschaft, Hagstrasse, D-2800 Bremen
- B. Rothfos, Kaffee-Import-und-Grosshandel, Sandtorkai 4-5, D-2000
Hamburg 11
- SCHMIDT W.
SCHRAIN J.
SCHULTHEISS W. - Bundesverband der Hersteller von löslichem Kaffee, Kelkheimer Str.
10, D-6380 Bad Homburg v.d.H.

SCHWEINFURTH H. STAVENHAGEN H.	- J. Jacobs GmbH, Langemarkt Str. 4, D-2800 Bremen - INGE, Institut für Genussmittelforschung, An der Stücken 55, D-2072 Bargteheide
SYLLA K.	- HAG Aktiengesellschaft, Entwicklungsabteilungen, Hagstrasse, D-2800 Bremen
THALER H.	- Institut für Lebensmittelchemie der technischen Universität, Fasanenstrasse 3, D-3300 Braunschweig
TRESSL R. ULRICH R. VITZTHUM O.	- Technische Universität Berlin, Seestr. 13, D-1000 Berlin 65 - Hauptgesundheitsamt, Homestr., D-2800 Bremen - HAG Aktiengesellschaft, Wissenschaftliche Abteilung, Hagstrasse, D-2800 Bremen
VODICKA H.	- Coffein Co, Dr. Erich Schiele GmbH, Postfach 448130, D-2800 Bre- men 44
VOGT S. WILKENS J. WURZIGER J.	- Jacobs & Co. GmbH, Langemarkt Str. 4, D-2800 Bremen - HAG Aktiengesellschaft, Hagstrasse, D-2800 Bremen - Bredkamp 43a, D-2000 Hamburg Blankenese

Angola

ABA J. PEREIRA S. VICKY M. WEBRA J. XISSLUCOMBE O.	- Empresa Nacional de Café "ENCAFE", C.P. 342, Luanda - Empresa Nacional de Café "ENCAFE", C.P. 342, Luanda - Empresa Nacional de Café "ENCAFE", C.P. 342, Luanda - Empresa Nacional de Café "ENCAFE", C.P. 342, Luanda - Empresa Nacional de Café "ENCAFE", C.P. 342, Luanda
--	---

Belgique

BYRNE J.	- General Foods (Europe), 14 avenue de l'Astronomie, 1030 Bruxelles
----------	---

Bénin

AKPO L. MADOUYOU Y.M.	- URP, Café, Cacao, Cola, Dpt de la Recherche agronomique, BP 884, Cotonou
--------------------------	---

Brésil

CASTRO A.	- Cia Iguacu de Café Soluvel, P.O.Box 199, Cornelio-Procopio, Parana, 86300
CORTEZ G.	- Instituto Brasileiro do Café, Av. Rodriguez Alves 129, Rio de Janeiro
GIANNI M.	- Cocam Cia de Café Soluvel e Derivados, Caixa Postal 86, São Paulo, S.P.
GUERREIRO H.	- Brazilian Coffee Institute, 767 Fifth av. 33rd floor, New York, N.Y. 10022
LIMA S. PAULA MOTTA J.	- Brazilian Coffee Institute, Green Street, London W.1. - Instituto Brasileiro do Café, Av. Rodriguez Alves 129, Rio de Janeiro
PEREIRA L. SONDAHL M.	- Cooperativa Regional dos Cafeicultores, Poços de Caldas - Instituto Agronomico, Seção Genetica, Caixa Postal 28, 13.100 Cam- pinas, S.P.
WATSON A. WEINBERGER J.	- F.M.C. do Brasil, rua Maria Monteiro 656 - Cambui, 13.100 Campinas - Cacique de Café Soluvel, Caixa Postal 1769, Londrina

Cameroun

- BOUHARMONT P. - IFCC, B.P. 2577, Yaoundé
ECKEBIL J. - DGRST, B.P. 1457, Yaoundé
MBOUNDJA BRUNO M. - Office National de Commercialisation des Produits de Base,
B.P. 378, Douala

Canada

- FERGENBAUM M. - Standard Brands Ltd., 1 Dundas Street West, 29th floor, Toronto
(Ontario) M5G 2A

Colombie

- BONILLA VIDALES C. - Université de Neuchatel (Suisse)
JARAMILLO H.
MARTINEZ VILLALBA B. - La Constancia, Apartado Aereo 555, Bucaramanga, Santander
POSADA E. - Federación Nacional de Cafeteros de Colombia, Apartado Aereo 3938,
Bogota DE 1
PUENTES A. - Federación Nacional de Cafeteros de Colombia, Apartado Aereo 3938,
Bogota DE 1
QUIJANO RICO M. - Federación Nacional de Cafeteros de Colombia, Apartado Aereo 3938,
Bogota DE 1
SIEVERS S. - Federación Nacional de Cafeteros de Colombia, Apartado Aereo 3938,
Bogota DE 1
VALENZUELA-SAMPER G. - Federación Nacional de Cafeteros de Colombia, Apartado Aereo 3938,
Bogota DE 1
ZAMUDIO V. - Federación Nacional de Cafeteros de Colombia, Apartado Aereo 3938,
Bogota DE 1

Congo

GREGOIRE B.

Costa Rica

- CLEVES-SERRANO R.
FERNANDES-URPI M. - Oficina del Café, Apartado 37, San José
MONTEALEGRE R.
SOLANO PEREZ V.

Côte d'Ivoire

- BERTHAUD J. - ORSTOM, B.P. 434, Man
BERTHOU F. - ORSTOM, B.P. V.51, Abidjan
CHARRIER A. - ORSTOM, B.P. V.51, Abidjan
DUCEAU P. - IFCC, 01 B.P. 1827, Abidjan 01
JOACHIM P. - SATMACI, B.P. 1565, Abidjan
KAAM M. - IACO, B.P. 210, Abidjan
KOUSSI A.
KOULIBALY
SNOECK J. - IFCC, 01 B.P. 1827, Abidjan 01
WORKU A. - IACO, B.P. 210, Abidjan

Cuba

CRESSEEAUX M. - Ministère de l'Agriculture, La Havane

Danemark

EHLERS G. - Novo Industrias A/S, Novo Alle, DK 2880 Bagsvaerd, Copenhagen
FOSEBØL P. - A/S Atlas, 154 Baltorvej, 2750 Ballerup, Copenhagen
PETERSEN E. - A/S Atlas, 154 Baltorvej, 2750 Ballerup, Copenhagen

Etats-Unis

BOST R. - General Foods Corp., 250 North Street, White Plains, N.Y. 10625
CALLAHAN W. - Arthur D. Little Inc., Cambridge, Mass. 02140
CARTER H. - Icore/Acurex Corp., 485 Clyde Av., Mountain View, California
CLINTON W. - General Foods Corp., 250 North Street, White Plains, N.Y. 10625
CROSBY W. - General Foods Corp., 250 North Street, White Plains, N.Y. 10625
HEYDEN S. - Duke University Medical Centre, Durham, N. Carolina 27710
GREEN J. - General Foods Corp., 250 North Street, White Plains, N.Y. 10625
HOPPER P. - General Foods Corp., 250 North Street, White Plains, N.Y. 10625
JACKSON P. - General Foods Corp., 250 North Street, White Plains, N.Y. 10625
JUDSON KING C. - Dept. of Chemical Engineering, University of California, Berkeley, CA 94720
KATZ S. - General Foods Corp., 250 North Street, White Plains, N.Y. 10625
LEVI C. - General Foods Corp., 250 North Street, White Plains, N.Y. 10625
SALEEB F. - General Foods Corp., 250 North Street, White Plains, N.Y. 10625
SIVETZ M. - Sivetz Coffee Enterprises, 3635 Elmwood Drive, Corvallis, Oregon 97330
SLOMAN K. - General Foods Corp., 250 North Street, White Plains, N.Y. 10625
STROEBEL R. - Procter & Gamble Ltd., P.O. Box 38175, Cincinnati, Ohio 45247
TARKA S. - Hershey Chocolate Co., 19 East Chocolate avenue, Hershey, Penn. 17033
WALLER G. - Oklahoma State University, Stillwater, Oklahoma 74074
WILHELM C. - General Foods Corp., 250 North Street, White Plains, N.Y. 10625
WURTMAN R. - Dept. of Nutrition & Food Science, Massachusetts Inst. of Technology, Cambridge, Mass. 02139

Ethiopie

ALEMAYAHU A.
MULETA A.

Finlande

SALO H. - SOK Roastery, Fleminginkatu 36, 00510 Helsinki 51

France

BAUME M. de la - Syndicat National de l'Industrie et du Commerce du Café, 17 rue de Constantinople, 75008 Paris
BELIN M. - IFCC, 42 rue Scheffer, 75016 Paris
BOULON R. - SOPAD, 17-19 Quai Paul-Doumer, 92400 Courbevoie
CALLEN D. - Museum National d'Histoire Naturelle, 16 rue Buffon, 75005 Paris
CAMBRONY H.R. - IFCC, 42 rue Scheffer, 75016 Paris

- CHASSEVENT F. - Chambre Syndicale Nationale des Chocolatiers, 194 rue de Rivoli, 75001 Paris
- COLLIN J. - Cafés Jacques Vabre SA, Les petites Haies, 5 rue Charles-Martigny, 94701 Maisons Alfort
- COLLOT J. - IFCC, 42 rue Scheffer, 75016 Paris
- COSTE R. - IFCC, 42 rue Scheffer, 75016 Paris
- CROS E. - IFCC, B.P. 5035, 34032 Montpellier Cedex
- DELAPORTE G. - Marchés Tropicaux et Méditerranéens, 190 boulevard Haussmann, 75008 Paris
- DUBLIN P. - GERDAT, B.P. 5035, 34032 Montpellier Cedex
- DURU L. - Chambre Syndicale des Torréfacteurs de Café de France, 10 rue de Rome, 75008 Paris
- FRANKEL J. - Syndicat National de l'Industrie et du Commerce du Café, 17 rue de Constantinople, 75008 Paris
- GUYOT B. - IFCC, B.P. 5035, 34032 Montpellier Cedex
- JACQUET M. - IFCC, B.P. 5035, 34032 Montpellier Cedex
- JOUANJAN F. - Compagnie Générale Maritime, Tour Winterthur, Cedex 18, 92085 Paris-La Défense
- LEROY J.F. - Museum National d'Histoire Naturelle, 16 rue Buffon, 75005 Paris
- MARCADET R. - Syndicat National des Fabricants de Café Soluble, 8 rue de l'Isly, 75008 Paris
- NAVILLIER E. - 8 rue Claude Bernard, 75005 Paris
- POISSON J. - Université de Paris-Sud, Centre d'études pharmaceutiques de Chate-nay-Malabry, rue Jean Baptiste Clément, 92290 Chatenay-Malabry
- VILMORIN P. de - Cafés Jacques Vabre SA, Les petites Haies, 5 rue Charles-Martigny, 94701 Maisons Alfort
- VINCENT J.-C. - IFCC, B.P. 5035, 34032 Montpellier Cedex
- VOILLEY A. - Université de Dijon, Ecole Nationale Supérieure de Biologie Appli-quée à la Nutrition et à l'Alimentation, Campus Universitaire, 2100 Dijon

Grande-Bretagne

- ADAMS M. - Tropical Products Institute, 56-62 Grays Inn Road, London W.C.1.
- BALLARD C.D. - General Foods Ltd., Banbury, Oxon.
- BARKER H. - Niro Atomizer Ltd., London
- BLENFORD D.E. - Westview, Cumnor Hill, Oxon.
- BROWN J. - Marks & Spencer Ltd., Baker St., London W.1.
- CLARK R.P. - Laboratory for Aerobiology, Clinical Research Centre, Harrow, Middx.
- CLARKE R.J. - General Foods Ltd., Banbury, Oxon.
- CLIFFORD M.N. - University of Surrey, Guildford, Surrey, GU2 5XH
- COURSEY D. - Tropical Products Institute, 56-62 Grays Inn Road, London W.C.1.
- CRISPIN D.J. - Brooke-Bond Liebig Ltd., Croydon, Surrey
- DOUGAN J. - Tropical Products Institute, 56-62 Grays Inn Road, London W.C.1.
- ESSLEMENT G. - Cadbury-Schweppes Ltd., Connaught Place, London W.1.
- FOX L.W. - Gunson's Sortex Ltd., Fairfield Road, London E.3, 2QQ
- GIBSON A. - World Bank Coffee Consultant, 32 Falcon Road, Bingley, Yorks.
- HARDING R.J. - Ministry of Agriculture, Food & Fisheries, London S.W.1.
- KAZI T. - Lyons-Tetley Ltd., London
- KHAN A. - Solcafé Ltd., 325 Oldfield Lane, Greenford, Middx.
- LOVE G. - General Foods Ltd., Banbury, Oxon.
- MANSKY M.H. - General Foods Ltd., Banbury, Oxon.
- MAUGHAN W.S. - Gunson's Sortex Ltd., Fairfield Road, London E.3, 2QQ
- MAYES G.D. - Nestle Co. Ltd., St. George's House, Croydon, Surrey
- MITCHELL H. - Brooke Agricultural International, London
- MOSS E.T. - Nestle Co. Ltd., St. George's House, Croydon, Surrey
- MOULDER D. - Solcafé Ltd., 325 Oldfield Lane, Greenford, Middx.

NOLTES A. - Coca-Cola Export Corp., 195 Knightsbridge, London S.W.7.
 OHIOKEPEHAI O. - University of Surrey, Guildford, Surrey
 PENDLINGTON P. - Unilever Research, Colworth House, Bedford
 REES D.I. - Solcafé Ltd., 325 Oldfield Lane, Greenford, Middx., UB6 OAZ
 SHERWOOD T.S. - Unilever Research, Colworth House, Bedford
 SLOANE R. - Solcafé Ltd., Oldfield Lane, Greenford, Middx.
 SMITH A.W. - Nestle Co. Ltd., St. George's House, Croydon, Surrey
 SMITH R.F. - 350 Dereham Road, Norwich, Norfolk, NR2 4DL
 STEMMAN C. - Solcafé Ltd., 325 Oldfield Lane, Greenford, Middx.
 STIRLING H. - National Research Development Corp., Kingsgate House, 66/74 Victoria Street, London S.W.1 E 6SL

 STOCK R.G.H. - General Foods Ltd., Banbury, Oxon.
 THORNE R.A. - General Foods Ltd., Banbury, Oxon.
 TURNBULL A.J. - Nestle Co. Ltd., St. George's House, Croydon, Surrey
 TURNER A. - Cadbury-Schweppes Ltd.
 VERRALL R.P. - General Foods Ltd., Banbury, Oxon.
 WALKER L.J. - General Foods Ltd., Banbury, Oxon.
 WARWICK LANG R. - Stork Bowen Ltd., Bromley, Kent
 WEIR G. - Brooke-Bond Liebig Ltd., Croydon, Surrey
 WINGROVE D.J. - Brooke-Bond Liebig Ltd., Croydon, Surrey
 WRAGG A. - General Foods Ltd., Banbury, Oxon.

Guatemala

BRAHAM E. - Incap, Carretera Roosevelt, Zone 11, Guatemala City

Inde

MATHEW P. - Coffee Board, P.P. 5366, Bangalore 560.001

Italie

VANNI A. - Lavazza Spa, Corso Novara 59, Torino
 BALESTRIERI F. - Istituto de Merceologia dell' Università di Roma, Via del Castro Lorenziano 3, 00161 Roma
 BRUMEN G. - Illycaffé Spa, Via Flavia 110, Trieste 34 147
 ERCOLANI U. - Crippa & Berger Spa, Via Laurentina, Km 7, Pomezia, Roma
 GAMBONI V. - Crippa & Berger Spa, Via Laurentina, Km 7, Pomezia, Roma
 ILLY E. - Illycaffé Spa, Via Flavia 110, Trieste 34 147
 MILO S. - Illycaffé Spa, Via Flavia 110, Trieste 34 147
 PAOLETTI R. - Istituto di Farmacologia, Università di Milano, Via A. Del Sarto 21, 20129 Milano
 ROARZI L. - Illycaffé Spa, Via Flavia 110, Trieste 34 147
 RODOLFO V. - Illycaffé Spa, Via Flavia 110, Trieste 34 147
 RUZZIER L. - Illycaffé Spa, Via Flavia 110, Trieste 34 147
 SALOMONE S. - Procter & Gamble Spa, Via C. Pavese 3815, C.Postale 10075, 00100 Roma
 SCHOUTEN H. - Crippa & Berger Spa, Via Laurentina, Km 7, Pomezia, Roma
 TOMASINA F. - Star Spa, Agrate Brianza, 20041 Milano
 VERTUA R. - Istituto di Farmacologia, Università di Trieste

Japon

FREY A. - Nestle Japan Ltd., P.O.Box 207, Kobe-Port 651-01

Kenya

- KULAABA G.W. - Kenya Industrial Research & Development Institute, P.O.Box 4,
Ruiru
Van der VOSSEN J. - Coffee Research Station, P.O.Box 4, Ruiru
WALYARO D. - Coffee Research Station, P.O.Box 4, Ruiru

Nigeria

- FILANI G. - Cocoa Research Institute of Nigeria, P.M.B. 5244, Ibadan
IDOWU O. - Cocoa Research Institute of Nigeria, P.M.B. 5244, Ibadan

Ouganda

- KYWKWASO-MUKIBI - Coffee Marketing Board, Kampala

Pays-Bas

- CUSTERS J. - Institute for Horticultural Plant Breeding, Postbus 16, 6700 AA
Wageningen
KAPER L. - Douwe Egberts Research & Development, P.O.Box 2, 3500 LA Utrecht
STARITSKY V. - Agricultural University, Dept. of Tropical Crops, P.O.Box 341,
6700 AH Wageningen
Van NISTELROOIJ M. - Grenco Special Applications, P.O.Box 304, s'Hertogenbosch
Van SCHAIK G. - Van Nelle-Lassie B.V., P.O.Box 817, 3000 DC Rotterdam
Van der STEGEN J. - Douwe Egberts Research & Development, P.O.Box 2, 3500 LA Utrecht
WORMER T. - Royal Tropical Institute, Mauritskade 65, Amsterdam

Portugal

- RODRIGUES C.J. - Centro de Investigação das Ferrugens do Cafeeiro, Oeiras P2780

République Centrafricaine

- DARLAN G.
DEMANDJI T.

Rwanda

- BAGILIMANA J. - Office des Cafés, Kigali
KAMPAYNANA C. - Office des Cafés, Kigali

Suède

- REIO L. - National Food Administrations, Stockholm
WILHELMSEN L. - Östra Hospital, University of Göteborg, S-416, 85 Göteborg

Suisse

- ACHESON K. - Institut de Physiologie, Université de Lausanne, 7 rue du Bugnon,
CH-1011 Lausanne

- ARNAUD M. - Société d'Assistance technique pour les produits Nestlé, P. 88,
CH-1814 La Tour de Peilz
- BAUMANN T. - Institut für Pflanzenbiologie, Zollikerstrasse 107, CH-8008 Zurich
- BONNE H. - Jacobs A.G., Zurich
- ERRASS W. - Thomi & Franck A.G., Basel
- FRISCHKNECHT P. - Institut für Pflanzenbiologie, Zollikerstrasse 107, CH-8008 Zurich
- HANDLI B. - Coffex A.G., CH-8201 Schaffhausen
- HORMAN I. - Société d'Assistance technique pour les produits Nestlé, P. 88,
CH-1814 La Tour de Peilz
- KOETZ R. - Institut für Pflanzenbiologie, Zollikerstrasse 107, CH-8008 Zurich
- KUMMER P. - Coffex A.G., CH-8201 Schaffhausen
- MORATH P. - Institut für Pflanzenbiologie, Zollikerstrasse 107, CH-8008 Zurich
- PFRUNDER R. - Institut für Pflanzenbiologie, Zollikerstrasse 107, CH-8008 Zurich
- PICTET G. - Laboratoire Industriel, CH-1350 Orbe
- REYMOND D. - Société d'Assistance technique pour les produits Nestlé, P. 88,
CH-1814 La Tour de Peilz
- SCHLATTER C. - Institut für Toxikologie, Universität Zurich, CH-8603 Schwergeng-
bach
- SOMOGY J. - Universität Zurich, CH-8008 Zurich
- SPECK P. - Haco A.G., CH-3073 Gmüli
- STALDER R. - Société d'Assistance technique pour les produits Nestlé, P. 88,
CH-1814 La Tour de Peilz
- VIANI R. - Société d'Assistance technique pour les produits Nestlé, P. 88,
CH-1814 La Tour de Peilz
- WURZNER H. - Société d'Assistance technique pour les produits Nestlé, CH-1350
Orbe
- ZULUAGA VASCO J. - Institut de Chimie, Université de Neuchâtel, 51 av. de Bellevaux
CH-2000 Neuchâtel

Togo

- AGBODJAN A.K. - IFCC, B.P. 90, Kpalimé

SÉANCE INAUGURALE

Présentations de MM. :

E. ILLY,

Président de l'ASIC

R. COSTE,

Secrétaire administratif permanent de l'ASIC

A. F. BELTRÃO,

Executive Director, international Coffee Organization

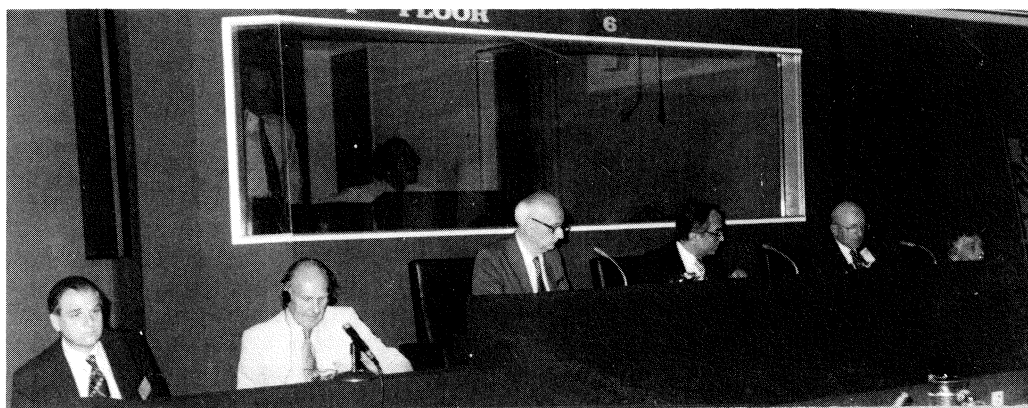

E. ILLY

Je remercie d'abord tous ceux qui ont contribué à la réalisation du IX^e Colloque, en particulier l'OIC et quelques grandes industries et associations qui se consacrent au café.

Un remerciement très chaleureux au Dr. Beltrão, Directeur exécutif de l'OIC, et à M. Clarke, pour leurs engagements personnels.

En qualité de fondateur de l'ASIC, avec M. Coste et l'inoubliable M. Navellier, je me permets de dire quelques mots sur ce qui a été fait, de positif et de négatif, depuis que l'ASIC est née, en 1965, d'une petite équipe d'hommes de science, qui avaient une seule chose en commun : l'amour pour le café. Depuis, notre Association est devenue très largement connue et son rayonnement s'est énormément élargi. Pendant ces quinze dernières années la recherche scientifique a fait des progrès gigantesques, d'abord dans le domaine de l'analyse chimique des composants, ensuite dans le domaine de la physiologie et de la pharmacologie, puis dans celui de la technologie, surtout en ce qui concerne la technique du café soluble, et enfin dans ceux de l'agronomie et de la génétique.

Ces domaines ont été mis sous les projecteurs au cours des divers colloques, en montrant comment, peu à peu, l'intérêt s'était étendu à une zone de plus en plus vaste : des molécules du grain de café torréfié, responsables de son arôme et de son action physiologique, à la plante, et à l'interaction complexe avec le système écologique dans lequel elle est insérée.

Toutes ces connaissances ont été bénéfiques dans le domaine de la quantité, qu'il s'agisse de quantité en kg de café vert par hectare cultivé, ou en gr de café soluble tiré de 1 kg de café torréfié.

Cette approche purement quantitative a été accompagnée, dans le marché mondial, d'accords entre pays consommateurs et pays producteurs, qui eux aussi mettaient toujours l'accent sur le problème de la quantité.

Les accords ont essayé de mettre en harmonie les marchés de la consommation, qui grandissaient avec un rythme d'environ 3% l'an, avec les marchés de la production, qui eux grandissaient avec des rythmes bien plus élevés.

Une série de catastrophes naturelles, parfois causées par l'homme, ont provoqué une modification draconienne de la situation vers les années 1975, et aujourd'hui nous vivons encore dans une situation d'équilibre instable entre consommation et production ; cette situation pourrait se développer d'une façon très préoccupante : dans la direction d'une surproduction, avec des prix non rémunérateurs pour le producteur, ou d'une production insuffisante, qui influencerait d'une façon négative le prix, et aussi la consommation.

C'est cette ligne directrice purement quantitative qui au fond n'a pas permis, d'une part, aux pays producteurs de maintenir les prix de leurs produits au niveau de l'inflation mondiale et qui a provoqué, d'autre part, le fléchissement de la consommation du marché mondial le plus vaste : celui des Etats-Unis, et une tendance dangereuse à la diminution de la consommation dans d'autres pays, bien que compensée, actuellement, au niveau européen par des augmentations importantes.

Il faut se demander si l'on ne peut pas établir un autre type de rapports entre producteurs et consommateurs, centré, cette fois, sur le caractère essentiel du café, qui réside dans le plaisir que l'on a en dégustant, et donc sur la qualité, plutôt que sur des prix réduits.

J'adresse à ces assises un appel, surtout aux responsables de la politique mondiale du café, qui sont les seuls qui peuvent prendre la décision de récompenser la qualité au lieu de la quantité, et je considère comme presque symbolique le fait que cet appel soit fait au siège de l'Accord International du Café, où nous, hommes de science, sommes aujourd'hui reçus. Ce fait arrive presque à prouver que la connaissance particulière que la science peut mettre à la disposition de l'homme s'ajoute au pouvoir de transformer cette connaissance en programmes, en incitations économiques et politiques, avec la force des membres de l'Accord International du Café :

la volonté de récompenser le café de qualité devrait permettre à l'avenir l'augmentation de la consommation par l'amélioration de la qualité, et l'augmentation des prix qui s'ensuivrait.

Le vin a réussi pendant les dernières années à se dégager des entraves des lignes directrices quantitatives de la production, et il représente maintenant un marché en pleine expansion et source de grande richesse pour les producteurs de vin de haute qualité, avec la collaboration de la recherche et de la volonté politique.

On pourrait atteindre les mêmes résultats avec le café, à condition qu'on le veuille.

Nous, savants, sommes prêts à donner notre collaboration afin que cette volonté se transforme en faits.

Récemment, ici au siège de l'OIC, a eu lieu une rencontre entre des opérateurs et des experts de pays producteurs et consommateurs. Cette rencontre avait pour but de préciser les différents aspects de la qualité en ce qui concerne la préparation de la tasse de café. Il s'agit d'une première démarche importante, et nous devons remercier M. le Dr Beltrão et M. Worcu, secrétaire de l'OIAC, qui se sont engagés à revaloriser la qualité. Il faut continuer à suivre ce chemin, en favorisant les contacts entre les hommes de science et les hommes d'action.

Il faudra travailler sérieusement pendant de nombreuses années; mais si nous restons fidèles à la constatation selon laquelle on boit du café parce qu'il est bon et non simplement parce qu'il existe, notre action pourra bien contribuer à augmenter la richesse des pays qui produisent le café, en leur permettant cette réalisation qui les fera passer du stade de dépendance agricole au stade d'indépendance industrielle.

R. COSTE

M. le Président,

Mesdames, Messieurs,

Je voudrais, aux côtés du Président Illy, et en ma qualité de Secrétaire Administratif Permanent, exprimer ma reconnaissance à tous ceux qui ont uni leurs efforts pour que ce IXe Colloque de l'ASIC ait lieu et qu'il soit, comme les précédents, une incontestable réussite.

En premier lieu ce témoignage de reconnaissance s'adresse au Dr Beltrão, Directeur Exécutif de l'Organisation Internationale du Café. C'est grâce à son concours que nous sommes ici réunis toute cette semaine. Le Dr Beltrão a toujours suivi, avec le plus grand intérêt, les travaux de l'ASIC et ses Colloques et nous a fait l'honneur, à plusieurs reprises, de nous consulter. Son appui moral nous était donc acquis. Mais, c'est bien grâce au concours financier important qu'il a accordé à l'ASIC au titre de l'Organisation Internationale du Café pour l'organisation de son Colloque et à l'hospitalité qu'il nous offre dans les locaux de cette organisation que cette rencontre internationale peut avoir lieu. Nous ne saurons jamais assez lui dire combien nous lui en sommes tous reconnaissants.

Un hommage exceptionnel doit être rendu au Bureau britannique d'organisation du IXe Colloque, présidé par le Dr Clarke, pour l'activité soutenue qu'il a déployée depuis près de deux ans pour préparer cette rencontre dans les moindres détails et assurer sa réussite, tant au plan de sa haute valeur scientifique qu'au plan de son organisation matérielle.

Nous associerons aussi à cet hommage les hautes personnalités, membres du Comité d'Honneur, pour l'intérêt qu'elles ont manifesté à l'ASIC en acceptant d'accorder leur parrainage.

Nos chaleureux remerciements s'adressent également aux Associations professionnelles et Sociétés industrielles qui ont bien voulu apporter leur appui financier pour nous aider à couvrir les frais élevés de cette manifestation scientifique.

Je n'aurai garde d'oublier le personnel dévoué de l'Organisation Internationale du Café (OIC) qui, par son dévouement, participe aussi à la réussite de notre rencontre.

Ainsi donc, nous voici, hommes de science et professionnels, une fois de plus, et nombreux, réunis pour faire le point sur les progrès enregistrés dans tous les domaines de la recherche caféière ces toutes dernières années.

L'ASIC, puis-je le rappeler, a été créée en 1966 à Paris, à l'initiative de quelques-uns d'entre nous, à l'issue du IIe Colloque organisé, comme le précédent, à Paris, par l'IFCC.

Depuis, tous les deux ans, une réunion a pu être tenue : ce furent successivement Trieste, Amsterdam, Lisbonne, Bogota, Hambourg, Abidjan ...

La première de ces réunions scientifiques groupait seulement une dizaine de spécialistes, dont les noms méritent d'être rappelés ou connus : Dr Illy, Dr Smith, Dr Wurziger, Prof. Reymond, Dr Levenson, Dr Navellier, hélas défunt, moi-même, qui furent les promoteurs et les fondateurs de l'Association. Le nombre des participants n'a cessé d'augmenter au fil des Colloques. Au dernier, celui d'Abidjan, fin 1977, on comptait près de 400 participants. Il est vrai qu'un voyage professionnel, auquel avaient pris part de nombreuses personnes, avait été organisé en marge du Colloque.

Au début, l'ASIC avait axé ses Colloques sur les recherches en chimie, technologie et physiologie. Depuis le Colloque de Hambourg, en 1975, l'agronomie a été adjointe et de ce fait la vocation de l'ASIC s'exerce dans tous les domaines de la recherche scientifique : chimie, technologie, physiologie, génétique, agronomie, etc ...

L'ASIC a, dois-je le souligner, le privilège actuellement d'être la seule Association Scientifique Internationale qui existe au plan mondial. Elle réunit la plupart des spécialistes de haut niveau de la recherche qui oeuvrent sur les caféiers, les cafés et leurs dérivés. Ses Colloques constituent, tous les deux ans, le lieu de rencontre où ces spécialistes exposent le résultat de leurs recherches et participent à un échange de vues, très ouvert, avec leurs collègues de même discipline.

La somme des documents scientifiques réunis par l'ASIC à l'occasion de ses Colloques, publiés dans des ouvrages de comptes rendus, constitue une somme très importante d'informations, d'un intérêt exceptionnel pour tous les professionnels du café.

Il est certes difficile d'estimer la valeur de l'ASIC et son importance par les professionnels ; on peut cependant assurer qu'elle est considérable à en juger par l'intérêt grandissant que ceux-ci lui portent, notamment en France.

A n'en pas douter, cet intérêt ne peut que s'accroître, aussi bien dans les pays producteurs que dans les pays consommateurs, étant donné les problèmes, de plus en plus nombreux, qui se posent aux uns et aux autres, dont la solution appartient aux hommes de science et nécessite le recours à des techniques de plus en plus complexes et délicates et la mise en oeuvre de moyens de plus en plus perfectionnés et sophistiqués.

Tous, chercheurs et professionnels, peuvent être assurés que l'ASIC ne faillira pas à son objectif tel que défini à l'art. 1 de ses statuts : établir un inventaire des connaissances scientifiques, techniques et appliquées et encourager, réaliser et coordonner des recherches susceptibles de contribuer à une meilleure exploitation des caféiers, des cafés et de leurs dérivés et à l'amélioration de sa qualité dans l'intérêt commun des producteurs, des négociants, des industriels et des consommateurs.

A.F. BELTRAO

Distinguished Delegates, Ladies and Gentlemen,

I am delighted that the Ninth International Colloquium on Coffee is being held at the headquarters of the International Coffee Organization and on behalf of the 67 Member Governments - 24 importing countries and 43 exporting countries - I welcome you all and wish you a most successful meeting. In my capacity as Chairman of the Promotion Committee I would also wish to extend special greetings to you from the exporting Members. They are responsible for the Promotion Fund and they have shown their appreciation of the work of ASIC on a number of occasions in the past and again this week by supporting the International Colloquia on coffee not only with words but also with a contribution from the resources of the Fund.

2. As Executive Director I am fairly accustomed to finding myself trying to help resolve often conflicting views of producers and consumers. I feel very happy that today I can set bridge-building aside. When I review the truly formidable programme of work which you have before you I am struck by its scope and its coverage of so many aspects of coffee from seed to cup. I detect a great harmony of purpose here in the effort to further our understanding of coffee and secure every possible improvement in it as an agricultural product, a most important item of world trade and a universally popular beverage. It is very impressive to see the way in which the most modern research techniques are being applied for this purpose and the degree of human dedication, painstaking application and sheer intellect which is involved.

3. The scientific territory is yours and I have no intention of trespassing upon it. You are going to have enough facts and figures to digest in the next few days without my adding to them. We will, incidentally, keep you plentifully supplied with coffee to help this digestion.

4. I would, now, like to explore with you for a few minutes the end product of your labours. How do they concern our Members and what benefits can they bring to producers and consumers? How do they affect the farmer and the drinker? How are they relevant to the problems which we face in seeking to achieve a healthy industry based on an expanding coffee economy? What lessons for the future can we draw from the experiences of the past?

5. The answers to the questions which I have asked vary from country to country and from age to age. Nevertheless I believe that we can discern an historical pattern in the relationship between research, both pure and applied, and the situation of Supply and Demand. Political events have an influence on this relationship. So let me share with you my views on recent developments and their implication for the work of scientists.

6. The period starting with the great economic depression of the 1930's and running through to the end of the 1939/45 War was one of very low prices for coffee with destruction of the surpluses which had been accumulated. There was little incentive for new planting or creative developments. Coffee was in the doldrums and there was little incentive for new research. A boom in demand in the post-War years resulted in stocks being quickly absorbed. There were supply shortages and, as a consequence, high prices. These lasted until about 1954. The big returns to be gained from coffee touched off an enormous interest in ways of expanding production. New lands were turned over to coffee in Africa, Asia and Latin America and many farmers came into coffee for the first time. It is greatly to the credit of the researchers and scientists, and to the extension services in producing countries, that despite the lack of incentives in the 1930's and 1940's new practices of husbandry were ready to be implemented, new varieties were ready to be brought into production and great strides made in controlling diseases and pests.

7. This was an exciting period. It was the great leap forward for coffee when the results of research were easy to see in higher yields and prosperous farming. Inevitably perhaps the boom was shortlived. The rush into coffee soon generated another cycle of surpluses and low prices. This cycle remained with us from about 1957 to 1975. In this era the emphasis was on restriction of planting and the search for alternative uses of land in the coffee areas. The

interest in new varieties and new husbandry techniques was low. This had a depressing effect on research work and again there was little incentive to apply the results of scientific labour.

8. An incident occurred in the early 1970's which showed the value of the continuing research into plant diseases and which also showed the spirit of internationalism among scientists. I refer to the appearance in Brazil of leaf rust disease. This was the first time it had been reported in the Western Hemisphere though its ravages had been felt for many years in Africa and Asia. To help control the spread of the disease in Brazil there was an enormous international cooperative effort resulting in a significant transfer of knowledge from research stations in Africa and Europe and this quick response to Brazil's call for help combined with objective and practical action on the part of the Brazilians resulted in a successful operation against rust. Today Brazil is lending support to other Latin American countries in the fight against rust.

9. The frost in Brazil in 1975 coupled with a reduction in production in some other producing countries because of political difficulties has resulted in a reduction in production. The large surpluses have disappeared. We have moved back to a situation in which there is again an interest in the expansion of production in many countries. This means that there is a new demand for high yielding varieties and improved farming techniques. Once again there is pressure on the scientists and researchers to produce results.

10. I am sure the scientists and researchers have been responding to meet the calls made upon them. On my travels I have seen many instances of the successful application of new ideas. For example, the recycling of water in Kenya for the wet processing of coffee is now carried out in such a way that less water is required. This has reduced the pollution in rivers and generally shows concern for ecology. In a large number of Latin American countries, the use of new varieties and planting techniques has already resulted in much higher yields per hectare. New genetic varieties more resistant to diseases and giving coffee of better quality are being successfully developed world wide. Another clear example of fruitful cooperation between policy makers, researchers and the coffee sector is the construction of a network of new coffee processing plants in the Ivory Coast which has resulted in an enormous improvement in the quality of the coffee produced in that country. I have been particularly impressed by what I have heard in many countries about the need for varieties resistant to disease, especially rust, and the priority which is being given to their development. A network of research centres exists and the exchange of technicians and plant material which is going on is extremely encouraging. I feel confident that in the near future all renewal or expansion of the tree stock will be through the planting of high yielding, disease resistant varieties.

11. It is my hope that as a counterpart to the scientific progress in the development of productive capacity, we may progress also in our long-running efforts to cure the economic ills which result from an over-exaggerated response to high prices, giving unwanted surpluses. We will obtain a healthy coffee economy with fair profit for all sides of the industry only if there is a close link between pure and applied research and sound economic and social management of land resources, production and supply policies. If this is not done, we will continue to see in the future a repetition of the past cycles of high and low prices, with scientists and researchers being used as a sort of emergency service and not as a permanent part of the process of coordinated production and marketing.

12. I appreciate that to be able to make progress in this direction, we will need more than rhetorical statements. We will need to harness the efforts of many people in many widely dispersed but nonetheless inter-connected fields. For example, progress in communications and weather forecasting may contribute considerably to a more stable coffee economy by providing a much broader knowledge of coffee and the outlook for its production. Also the use of satellite photography should make possible an accurate assessment of the world's coffee tree population which has not been possible up to now. This type of information, combined with a better knowledge of yields and the age and type of trees planted, could act as a deterrent to prevent the over-expansion of production.

13. The considerations which I have advanced point to the need for improvement in communications between growers and researchers and between Governments and research bodies in producing countries. This improvement should aim at a more rational use of new varieties and new techniques in general and more specifically at the following :

- (a) the achievement of an adequate supply of coffee through the constant renewal of the stock of trees. This must be done so as to avoid a rush of planting from time to time followed by long periods of no planting and deterioration of the coffee tree population ;
- (b) improved yields per hectare. This would permit the liberation of land and labour now employed on coffee for use in the development of other crops including foodstuffs when necessary ;
- (c) the protection of trees against diseases and pests through the development of new and improved pesticides and herbicides which are compatible with the concerns of environmentalists and consumers ;
- (d) better quality through improvement in the techniques of husbandry, processing including washing and drying and transportation ; and
- (e) a more comprehensive exchange of information on research policy and the economic aspects of the coffee economy and strengthening of efforts to improve the comparability of statistical data.

14. From the point of view of the consumer, we have seen during the last thirty-five years considerable changes in life-styles in the consuming countries. It is to the credit of those who produce coffee and manufacture it that it is still today the most popular beverage in the Western world. The scientific world must take its share of the credit for the contribution which it has made, enabling coffee to adjust to new times. Here, however, I must say that we are looking to scientists and to all those responsible for the future of coffee for a still greater effort. It is all too evident from the market research which we carry out that coffee cannot face the future with complacency. Young people are not turning to it as readily as they did in the past, and there is at large in the world today a new preoccupation about all foodstuffs and beverages and their impact on health which we cannot ignore. I believe too that the consumer is becoming increasingly aware of his rights to demand that the product which he buys is of good quality.

15. I am encouraged when reading your agenda, to see the number of papers that are being prepared under the heading "process and technology". It is my personal feeling that improvements in transportation and the storage of coffee are of top priority in our fight for the quality of the product. In saying this, I am not overlooking the importance of the many other papers which are being presented on the processing of coffee and those relating to the chemical analysis and composition of the bean. Everything that contributes to a greater knowledge of coffee is a welcome advance. As I said a minute ago, we must recognise that consumers in the 1980's are going to be increasingly aware of the physiological effects of coffee on their health. I am delighted to see from the agenda that scientists of a high calibre are going to address themselves to subjects related to this matter. This is not a topic which we wish to be avoided or treated lightly ; it is a matter which we would wish to see treated according to the rules of scientific research. Attacks have been made on coffee and in my view these have all too often lacked a scientific basis. I believe that it is our responsibility to see that true facts about coffee are ascertained. At the same time I believe that we must step up efforts to emphasise the extremely positive contribution which coffee can make as a household beverage in a healthy, energetic and modern society.

16. We know that people are loyal to coffee. This has been proved over the centuries. We also know that they are willing to change habits and customs in response to new ideas. An illustration of this is the development of soluble coffee as an important factor in the industry within living memory. Another illustration is the rapid spread of the automatic drip coffee makers which were unknown ten years ago and now enjoy a large share of the market in the United States and other countries for brewing coffee at home. I would add also the development of the espresso machine.

17. I would like to qualify my remarks about progress by saying that I am not at all sympathetic to the claims made by some brands that more coffee can be extracted from one kilo of their coffee than from that of their rivals. Nor am I sympathetic to the claim that certain additives or mixtures eliminate "bitterness" from coffee or give it some other attraction. These

claims are sometimes heralded as scientific breakthroughs. I regard them as poor marketing devices which delude consumers. Happily the faithfulness of consumers to pure coffee has defeated the majority of these efforts.

18. But perhaps when we think of the effect on the consumer of new machines, new tastes, we should remember that coffee is a very individual drink. The way in which it appears in the cup in its final form depends to a very large extent on the decision of the person making it. We can influence the final brew by providing good quality coffee and good brewing devices. We can also make consumers aware, through promotion and advertising, of the many rewards of quality. In the end, however, the final consumer will always have an element of choice. This helps to make coffee the special drink it is.

19. Ladies and gentlemen, I believe I have taken up enough of your time. You have a busy series of sessions ahead, and I would just like to say that I am confident that this Ninth International Colloquium on Coffee will again make a positive contribution as other Colloquia have in the past, towards the development of coffee as a truly popular beverage. I repeat I am delighted that the Colloquium is being held at the headquarters of the Organization, which we regard as the forum for discussions on all matters related to coffee. I look forward to the many papers to come and I am optimistic that each one of them in its own way will provide information which can be put to use for the benefit of coffee.

20. It is my sincerest hope that the details provided by scientists will be progressively put to use in a logical, practical way, closely linked to the orderly development of supply and demand. If a close inter-action between scientists, producers and consumers can be progressively developed, you will help producers to progress and consumers to enjoy a high quality cup of coffee, and I believe that your life as scientists and researchers will be the more rewarding.

LA CIENCIA Y LA TECNOLOGIA PARA UN PAÍS PRODUCTOR

M. QUIJANO RICO

Director LIQC

Federación Nacional de Cafeteros de Colombia

Apartado aereo 3938, Bogota, Colombia

"El aprovechamiento conjunto de la Tecnología es un punto de interés mundial en el que todos los países tienen mucho que aprender, los unos de los otros. Pero es sin duda el más importante para los países en vía de desarrollo. Se puede incluso afirmar que su debilidad fundamental se debe a que no tienen acceso a la Tecnología o que no disponen de ella. La adquisición de la Tecnología es decisiva, no solamente para el crecimiento mismo, sino como condición de éste. La prioridad en las metas económicas y sociales de un país en desarrollo determinan la selección de la Tecnología y son determinadas por la Tecnología. Por otra parte un país aprovecha la Tecnología y la puede adaptar a sus necesidades únicamente cuando dispone de una estructura receptora capaz de acoplar las nuevas Tecnologías con su sociedad. El esfuerzo de los países en desarrollo por alcanzar una mayor independencia tecnológica debe apoyarse sin vacilaciones por medio de la cooperación internacional."

De, Das Ueberleben sichern/Asegurar la supervivencia, Informe de la Comisión Norte-Sur, Colonia, 1980.

Introducción:

Constituyen los Coloquios Científicos sobre el Café para muchos de nosotros prácticamente, la oportunidad para intercambiar ideas y almacenar importantes informaciones, útiles para el progreso de nuestro trabajo, con las cuales constituimos una reserva de base que renovamos en la próxima ocasión que es el siguiente Coloquio.

Me refiero a quienes venimos de los países en vía de desarrollo y no tenemos la misma facilidad de acceso frecuente a la discusión y a la información especializada que tienen nuestros colegas de los países desarrollados, bien sea porque la participación en otras reuniones científicas que tienen que ver directa o indirectamente con el tema, no es posible o porque la actividad científica y la calidad de la información en nuestro medio, no son a menudo comparables a las que se producen en los países industrializados.

La ASIC ha logrado reunir en sus Coloquios un número cada vez mayor de participantes, de los países productores y consumidores, del sector público y del sector privado, de las universidades y de la industria. Por otra parte, todos conocemos la importancia que tiene el café en las transacciones internacionales y al nivel de

las economías nacionales de los países productores e incluso, de los consumidores. Constituyen pues estos Coloquios, que se realizan alternadamente en países productores y consumidores, uno de los foros más interesantes para el contacto y el diálogo que se ha dado en llamar de Norte-Sur, entre dos mundos que conviven en el mismo planeta. Estas no son las únicas razones de la importancia de los Coloquios de la ASIC como foros del diálogo Norte-Sur. Se trata además de reuniones de carácter científico y técnico en las cuales se concentra así sea por un breve período, un considerable potencial Científico y Tecnológico. Son precisamente la Ciencia y la Tecnología, o mejor dicho, su ausencia más o menos grande en la vida de los países en desarrollo, uno de los más poderosos factores del subdesarrollo.

Para los países productores de café, el desarrollo de la investigación científica sobre el café tiene implicaciones que desbordan el campo especializado y que pueden ser altamente benéficas para el desarrollo científico y tecnológico general de cada país. Por el hecho de reunir con frecuencia un potencial económico considerable, las organizaciones nacionales que manejan la agroindustria cafetera, especialmente en aquellos países en que el café ocupa una posición relevante en la economía, tienen características que las convierten en portadores extraordinarios para la iniciación e inducción de actividades científicas y técnicas eficaces a relativo corto plazo en el proceso de desarrollo. Las características de las organizaciones de manejo de las producciones cafeteras nacionales a que nos referimos, dependen de la importancia económica del café para el país productor. Reúnen en general gente de competencia sobresaliente, la cual, por las mismas funciones que desempeña, está en contacto más estrecho con la metodología y las tendencias del mundo exterior, el más avanzado. Al más alto nivel, dichas organizaciones cuentan por lo tanto con gente excepcionalmente receptiva hacia la Ciencia y la Tecnología, y consciente de la importancia que tienen, A. Gómez-Jaramillo (1977).

Además tales organizaciones están asociadas al manejo de fondos considerables. Sobra decir que por estas mismas razones, la responsabilidad que tienen ante su país es proporcional a la importancia del papel que juegan y desborda el marco del café. Desde este punto de vista la ASIC con el apoyo de los países productores, podría desarrollar una labor importante en la inaplazable cooperación Norte-Sur a través del café. Es oportuno antes analizar cuáles son las relaciones entre la Ciencia y la Tecnología con el desarrollo y cuáles son los obstáculos para su transplatación con éxito a los países en vía de desarrollo y su acople eficaz al proceso de desarrollo.

2. Ciencia y Tecnología, desarrollo y subdesarrollo

Pese a la importancia que tiene el avance tecnológico sobre el fenómeno del crecimiento económico, éste ha sido llamado la "tierra incógnita" de la economía moderna, Smookler (1966). Las bases de juicio siguen siendo más subjetivas, que objetivas. Sin embargo, el reconocimiento de la importancia de la información como vector primordial del desarrollo, Jenner (1966), comienza a revelar las raíces de la acción de la Ciencia y la Tecnología sobre el progreso socio-económico. En este caso las palabras de Manfred Eigen (1978) sobre entropía, irreversibilidad y producción de información resumen el problema: "Un mensaje que se recibe, debe ser comprendido. Para ello debe revelar su significado, es decir debe estar relacionado con determinadas experiencias o convenciones y reproducirlas. Simultáneamente, el establecimiento de la relación, el ordenamiento, la comprensión son al mismo tiempo un acto de creatividad".

Desde el punto de vista sociológico, "una de las características principales de un país en desarrollo es su incapacidad para cubrir los costos de un nivel de vida apropiado para su población. Para uno de estos países el desarrollo económico es un proceso dinámico de cambio estructural caracterizado por tres factores: (1) crecimiento económico absoluto y sostenido (2) progreso científico y tecnológico y (3) propagación social de los efectos de los dos primeros factores a todos los sectores de la población. El factor del progreso tecnológico se refiere a la capacidad autónoma de un país para generar, diseminar y utilizar los conocimientos científicos y tecnológicos en su proceso social y productivo. Este progreso no implica rechazar la tecnología importada del exterior. Mas bien subentiende la habilidad para importar, absorber y modificar el "know how" del extranjero", Sagasti (1973). Este año-

lisis contiene implícito el proceso que ya mencionamos de producción y captación de la información contenida en un mensaje. Es evidente que el problema de los países en vía de desarrollo, en cuanto a lo que tiene que ver con la producción y captación de informaciones definidas, no está en la indisponibilidad de ellas. Por ejemplo: la literatura científica y técnica disponible para todos, contiene las más variadas y ricas informaciones. El problema está en la incapacidad de estos países para captar e interpretar correctamente el mensaje. En otras palabras, el más eficiente receptor de informaciones es al mismo tiempo el más eficiente productor de informaciones. La importancia de la Investigación Científica y Tecnológica para el desarrollo desde este punto de vista, estriba en el hecho de que implica la formación de productores de información, los cuales son de hecho receptores. El paso siguiente, constituido por la materialización de la información al introducirla como constituyente valorizador en los productos industriales, se resume en las palabras de Ernesto Illy: "países que pueden considerarse ricos por su patrimonio de materias primas se debaten en la pobreza porque han despreciado la parte más importante del proceso de producción de riqueza: la transformación de las materias primas en productos manufacturados, la valorización de la materia con la información", Illy (1979).

3. Dificultades para la realización de la Investigación Científica en un país en desarrollo

El marco, la organización y la metodología en los que se desenvuelve la Investigación Científica moderna son el resultado de la experiencia acumulada en la tradición que tienen en este campo, los países más desarrollados. Como la investigación científica que se realice en un país en vía de desarrollo debe, para ser útil, ajustarse a las normas y patrones de la investigación científica internacional, es necesario transplantar y adaptar un "micromedio" en el cual se desenvuelva, al país en que se realiza. En este micromedio las condiciones y requerimientos para la realización de la investigación no pueden diferir notablemente de los usuales en los centros de investigación de los países más avanzados.

Entre los factores negativos con que se debe contar para la organización de un centro de investigaciones en un país en desarrollo se cuentan, Quijano-Rico (1974):

- 1) Deficiencias educacionales y universitarias para la formación de científicos y de técnicos. La investigación es incipiente en las universidades.
- 2) Ausencia de una componente científica en la vida cultural suficiente para obrar como fuente de estímulo y actualización a nivel nacional.
- 3) Insuficiencia de las bibliotecas y fuentes de información.
- 4) Barreras aduaneras y dificultades de orden administrativo.
- 5) Insuficiencia de los créditos destinados a la investigación.
- 6) Remuneración insuficiente del personal especializado.

Los factores negativos que hemos enumerado conllevan a varias dificultades, las más difíciles de obviar:

- a) Baja oferta local de personas competentes y/o promisorias en el campo de la investigación. Al respecto Olga Gasparini (1969) anota lo siguiente: "el poco desarrollo de la investigación en nuestro medio y algunas características de nuestra educación, como son por ejemplo la tendencia a la memorización y el poco estímulo a la creatividad contribuye a crear y mantener una situación de dependencia cultural. Ello consiste en un tipo de relación en donde una de las partes permanece ligada a la otra y subordinada a ella. Con frecuencia este tipo de relación di-

ficulta el trabajo original y creador". Probablemente esta es una de las mayores barreras a la integración del investigador con las posibilidades para la investigación que ofrecen los problemas propios de su medio y es incluso frecuente en los investigadores locales formados en el extranjero. En los países más desarrollados la creatividad científica y su corolario, la innovación tecnológica constituyen la clave del crecimiento económico, Gee (1975). Esta premisa es también aplicable a los países en vía de desarrollo, pero en estos últimos la innovación tecnológica debe tener como objeto el aprovechamiento del fenómeno a recurso local en su contexto: "promover la industrialización que no es simplemente imitativa, pero que se construye sobre cualquier ventaja natural que esté presente y esperando su aprovechamiento" Carey (1978). Es decir que los científicos útiles para la sociedad en el país en desarrollo también son aquellos creativos en el sentido de Landau (1971): "los que poseen la habilidad de encontrar relaciones entre experiencias conocidas para combinarlas de manera a obtener nuevas formas de esquemas del pensamiento constituidas por nuevas experiencias, ideas o productos", capaces además de sobreponerse a la barrera de la dependencia cultural mencionada, para usar su creatividad en el proceso de desarrollo local y no en el del exterior.

- b) Aislamiento de los investigadores de la corriente científica con la consiguiente degradación de su capacitación y la inevitable desactualización. Ya discutimos del interés que para la solución de este problema tienen los Coloquios Científicos de la ASIC y tendría una acción coordinada y sostenida para promover encuentros, intercambios, reuniones, realización conjunta de investigaciones, utilizando la infraestructura probada de la ASIC con el apoyo económico de un fondo aportado por los países productores y de otros que quisieran contribuir.

4. El tipo de investigación y las técnicas de investigación para el país en desarrollo

Según el grado de desarrollo que tenga el país, coexisten en él dos conjuntos, uno de los cuales es relativamente mucho más avanzado que el otro, pudiendo ser el más dinámico. No existe por lo tanto un tipo único de investigación o de tecnología, para formularle al país en desarrollo, sino de todos los niveles, desde el más elemental hasta el más sofisticado. Todo depende del sector al cual se hallen integrados y de las solicitudes que éste reciba del mundo exterior.

La agroindustria del café constituye precisamente en nuestro país un sector clave de la economía, teniendo sus productos la mayor parte del mercado en los países más desarrollados.

Por otra parte, la misma problemática con que tropieza la investigación en un país en desarrollo define los tipos de investigación que deben tener prioridad y su metodología.

Para lograr atraer y retener a investigadores promisorios, los cuales rehuyen las áreas científicamente poco halagadoras, es indispensable situar el área de investigación a un nivel atractivo y estimulante. Por otra parte se debe evitar que el investigador pierda la orientación respecto a su último objetivo, el cual debe estar asociado al desarrollo del país.

Es necesario acumular suficiente variedad de especialidades como para contar con un mínimo de inter fertilización intelectual y de amplitud de la comprensión. Se debe poder contar con medios de investigación comparables a los que tienen a su disposición los investigadores de los países más desarrollados.

Sin llenar estas condiciones se corre el riesgo frecuente de pisar caminos ya recorridos, sin la misma seguridad con que otros lo hicieron. Se aleja así cada vez más la investigación de su objetivo y de sus posibilidades.

5. La experiencia de nuestro laboratorio

Organizado teniendo en cuenta los diferentes aspectos a que nos hemos referido, nuestro laboratorio comenzó a funcionar prácticamente en el año 1974. Se ha tratado de realizar simultáneamente investigaciones del tipo exploratorio, incluidas algunas más o menos fundamentales, e investigaciones aplicadas complementadas por actividades de desarrollo.

Actualmente contamos con 40 investigadores: Investigadores Asociados, Investigadores Invitados, diplomandos y doctorandos, con becas de la Federación Nacional de Cafeteros y huéspedes de universidades nacionales. Este equipo se reparte en cuatro grupos de trabajo: Química Aplicada, Bioquímica Especial, Química Analítica y Física Técnica.

FIG. 1: EVOLUCION DE LA PRODUCTIVIDAD DEL LIQC (INFORMES & PUBLICACIONES) POR TIPOS DE ACTIVIDAD/
EVOLUTION OF THE LIQC PRODUCTIVITY (REPORTS & PUBLICATIONS) ACCORDING TO ACTIVITY TYPE.

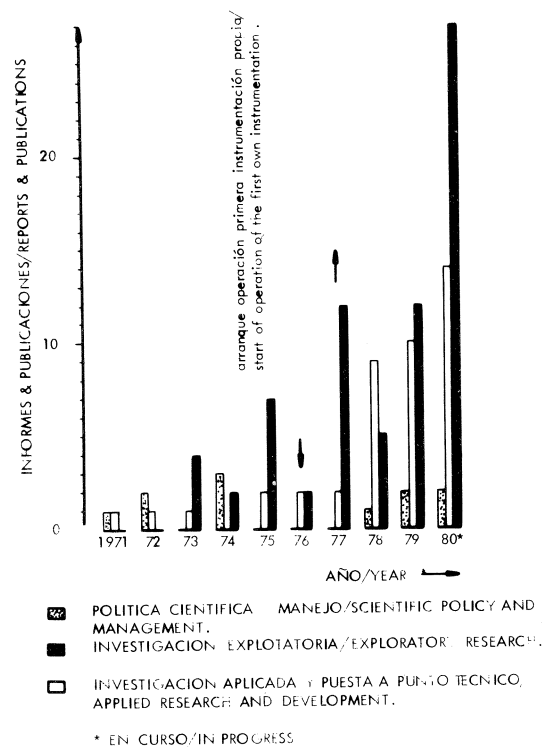

La figura 1 muestra la evolución del número de informes y publicaciones producidas en el laboratorio desde sus comienzos, diferenciadas de acuerdo con el tipo de actividad.

El laboratorio está dotado con los equipos modernos usuales en el tipo de investigación que adelanta.

El programa de becas y de entrenamiento de huéspedes de las universidades permite preparar y seleccionar a investigadores promisorios desde el momento en que salen de la universidad. La mayor par-

te recibe por intermedio del laboratorio becas de países industrializados para realizar estudios de post grado.

Se mantienen buenos contactos con centros del extranjero, especialmente con el Instituto Max Planck para la Química en Mainz, y el Instituto Francés del Café y del Cacao. El programa de Bioquímica Especial se realiza en colaboración con la Sociedad de Cooperación Técnica de la República Federal de Alemania.

6. Algunas investigaciones y resultados

En un informe reciente se han reunido los resúmenes de los informes y publicaciones hechos en el laboratorio desde su creación, LIQC (1980). Sería largo enumerarlos aquí en algún detalle. Nos vamos a limitar a algunos casos que son ilustrativos sobre el encadenamiento investigación exploratoria-investigación aplicada-desarrollo, que es el tipo de aproximación que empleamos y sobre los métodos de investigación que utilizamos.

7. Ejemplos de técnicas de investigación

7.1 Estudios sobre compuestos volátiles

La utilización de métodos de investigación en un campo como el del café es en su mayor parte un asunto de análisis químico. Estos deben ser suficientemente sensibles y producir informaciones confiables, se realizan con frecuencia con aparatos sofisticados, entre los más usados, la cromatografía de gases y de líquidos y la espectrometría de masas, en general en línea con una cromatografía. La familiarización a fondo con estas técnicas, relativamente complicadas, constituye también un excelente entrenamiento para el investigador, Quijano-Rico (1973)a.

El análisis de muestras complejas de volátiles, por ejemplo: aromas de cafés en el seguimiento y optimización del procesamiento industrial, Quijano-Rico (1973)b., o de volátiles de hojas en el estudio de la bioquímica de la hoja del cafeto, Moreno et.al. (1980), la técnica empleada en el laboratorio permite hoy el análisis de rutina con una reproducibilidad mejor que el 1% en los tiempos de retención y del orden del 4% a un nivel de confianza del 95%, para las áreas de los picos, F. Chapparro (1980). Estas características se obtuvieron mediante la automatización de la secuencia de las operaciones posteriores al enriquecimiento de los volátiles sobre Tenax, J.I. Jaramillo (1980). La figura 2 es una vista parcial del sistema utilizado. Todo el sistema automático fue diseñado y ensamblado en el laboratorio. El servicio, reparaciones y modificaciones de los equipos, se hacen por personal del laboratorio. En la figura 3 se comparan los aromagramas de un extracto de café concentrado por congelación y del agua separada del mismo. La figura 4 muestra la comparación entre un extracto concentrado por evaporación y el agua de condensación del evaporado. Estas figuras dan una información objetiva sobre características de los dos procesos. Para saber cuáles son los compuestos afectados por el procesamiento, la columna capilar del cromatógrafo de gases (Carlo Erba, Milán) está acoplada directamente en línea con un espectrómetro de masas de alta resolución (Jeol, Tokio), hasta ahora se han identificado unos 60 compuestos volátiles en cafés y sus extractos, Bautista, Moreno, Ablanque (1980) y 15 en hojas de cafetos, Ablanque, Moreno, Bautista, Sievers (1980). Actualmente se trata de establecer relaciones entre las propiedades físicas de los extractos industriales de café y la evolución del perfil de volátiles, A. Ortiz, et.al. (1980).



Figura 2: Vista parcial del sistema de cromatografía de gases - espectrometría de masas.





FIGURA 4-A
 FIGURA 4-B
 COMPARACION DEL PERFIL DE VOLATILES DE UN EXTRACTO INDUSTRIAL DE CAFE
 CONCENTRADO POR EVAPORACION Y EL AGUA CONDENSADA.

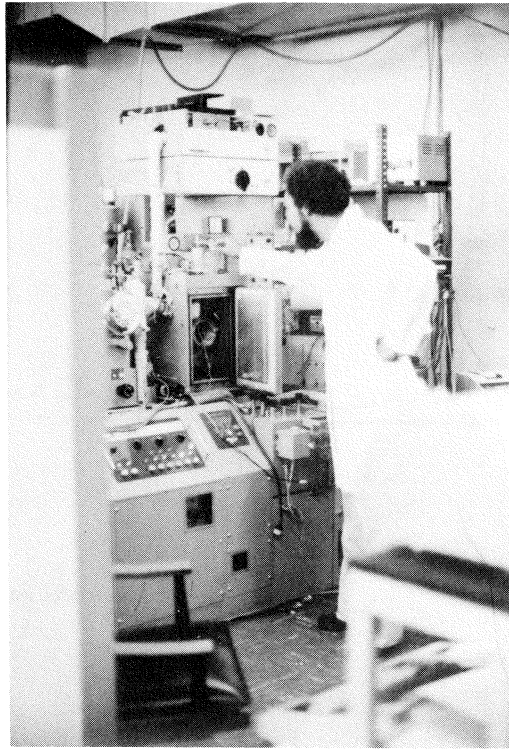
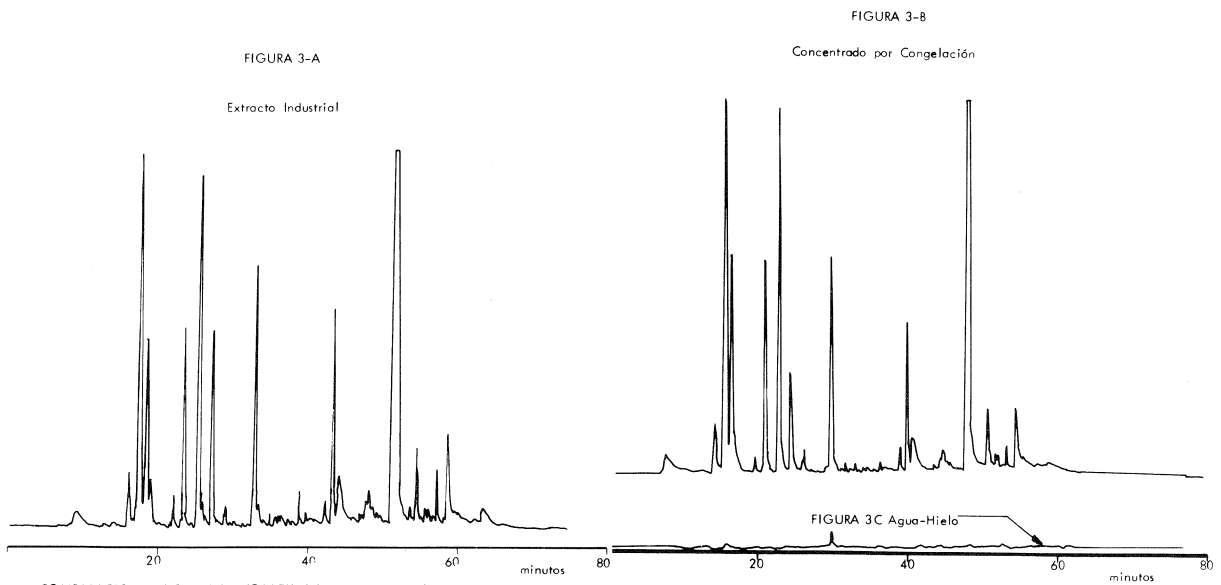

FIGURA 4-C

7.2 Determinación de elementos químicos al nivel de trazas

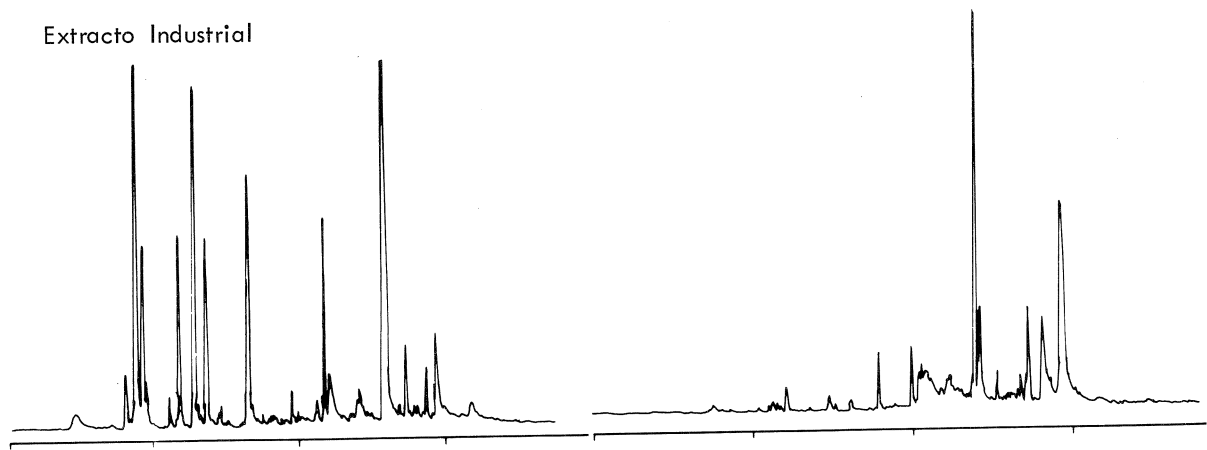
En este caso de nuevo, el problema principal es la obtención de datos confiables. El método más confiable y uno de los más sensibles, aunque dispendioso, es el análisis por radioactivación, en especial el análisis multielemental, con neutrones térmicos. Este es prácticamente un método patrón. Para el análisis simultáneo de muchos elementos con alta sensibilidad, la combinación de la clásica emisión atómica con la excitación por un plasma de muy alta temperatura tiene la ventaja de un ritmo de análisis elevado, 1 a 2 minutos por muestra. Los resultados obtenidos concuerdan en un margen de máximo 8%, Juana Gutiérrez, M. Quijano-Rico (1979), F. Chaparro, et. al. (1979).

7.3 Investigación fundamental y exploratoria, bioquímica

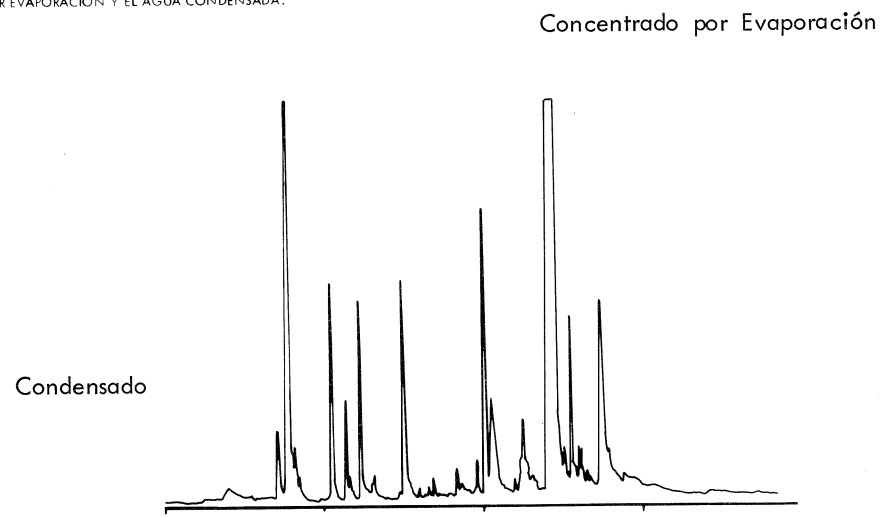
Un laboratorio de investigación científica sobre el café en un país productor debe incluir ramas de la ciencia que le permitan escudriñar al producto desde su más remoto origen. La bioquímica ofrece con este fin un potencial considerable. Además abre perspectivas promisorias en áreas de interés inmediato como es la protección contra la denominada roya del cafeto.

Una de las direcciones que se exploran está constituida por la Bioquímica Inorgánica, en especial el estudio de la distribución de los bioelementos. Se asumió, Quijano-Rico (1977) (1978), que para un país productor el estudio de los bioelementos puede ser fructífero: están ligados a las macromoléculas enzimáticas y por lo tanto a características y funciones esenciales de la planta, tienen importancia como fertilizantes, pueden jugar un papel notable en la calidad de las bebidas y de los productos del café, algunos son además utilizados a gran escala para la protección contra los hongos. Su más relevante característica está asociada a fenómenos catalíticos. Su efecto se ejerce a muy bajas concentraciones. Constituyen por lo tanto eficaces medios de acción. Por último, son accesibles con relativa facilidad a métodos sensibles y rápidos de análisis. A partir de los datos del contenido en elementos trazas en hojas de café, obtenidos anteriormente, Gutiérrez, Quijano-Rico (1978), Chaparro et.al. (1978), se deduce que existen en las hojas de los cafetos analizados de dos regiones diferentes en Colombia, correlaciones entre el contenido entre elementos y especies y variedades y correlaciones interelementos. Este fenómeno había ya sido observado, Quijano-Rico, Spettel (1975) con mayor claridad, en granos de cafés verdes. Teniendo en cuenta las intercorrelaciones observadas Mn-Mg, ya descritas en sistemas biológicos, Hughes (1972) y Cu-Sr-Ba-Ca, llevamos en la figura 5 la relación Mn+Mg/Cu+Sr de una localidad (Chinchiná) en comparación con la misma relación en otra localidad (Viotá). Las diferentes especies y variedades analizadas se reparten en dos grupos definidos: el de la relación más baja (menor contenido en manganeso), C. canephora, C. libérica y el híbrido de Catimor y el de la relación mayor (mayor contenido en manganeso), en la cual se sitúan los C. arabica, el C. eugenioides, y el Híbrido de Timor.

VALORES EN HOJAS DE CAFETOS DE LA RELACION $Mn + Mg / Cu + Sr$ EN VARIAS ESPECIES Y VARIEDADES DE DOS LOCALIDADES DIFERENTES.

FIGURA 5

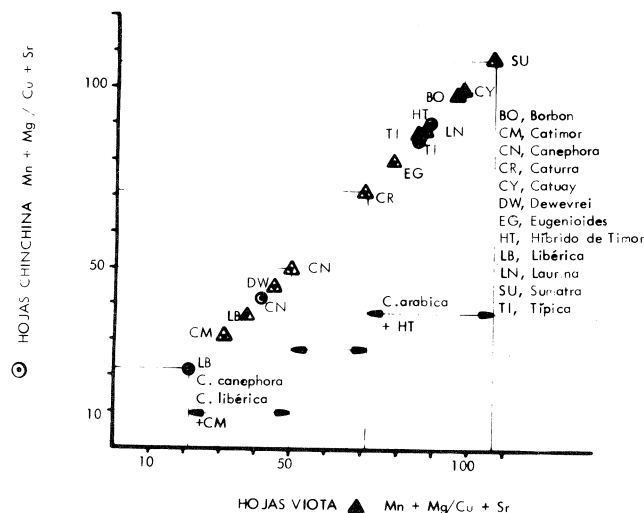

En la gráfica de la figura 6, hemos llevado el contenido en manganeso de granos de café verde de varias especies y variedades, de otras plantas y de otras épocas, en función de la relación Mn+Mg/Cu+Sr de hojas de cafetos de las mismas especies y variedades promediadas para las dos localidades. Es notoria la correlación entre el contenido en manganeso en los granos y el valor de la relación Mn+Mg/Cu+Sr en la hojas. Además en este caso la diferenciación de los grupos constituidos por una parte por C. canephora y C. libérica y por la otra por C. arabica y el Híbrido de Timor es mucho más definida. El grano de café integra en el tiempo las múltiples variaciones a que la hoja está sometida. Evidentemente de este comportamiento se pueden sacar varias conclusiones relacionadas con el papel de los bioelementos y de sus posibles aplicaciones.

CONTENIDO EN MANGANESO DE GRANOS DE CAFFINO DE LA MISMA EPOCA, NI PLANTA) EN FUNCION DE LA RELACION $Mn + Mg / Cu + Sr$ DE HOJAS DE CAFETOS DE VARIAS ESPECIES Y VARIETADES.

FIGURA 6

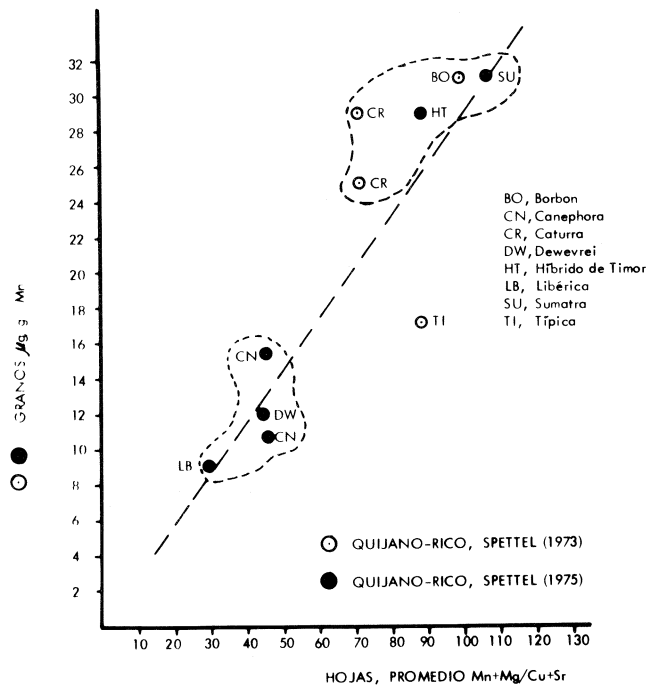

En otro caso, se estudió el efecto de los iones Mn^{++} y Cu^{++} sobre las esporas de la roya del clavel, *Uromyces dianthi*, figura 7, Isabel Bravo, M. Quijano-Rico (1979). Se observa que a muy pequeñas concentraciones, del orden del 1 $\mu g/g$ el manganeso es un potente promotor de la germinación, mientras el cobre es un inhibidor como es bien sabido. Los dos elementos son también en este caso antagónicos. Observamos además que el manganeso puede ejercer un efecto protector sobre el de inhibición del cobre en las mismas esporas.

Entre los productos químicos utilizados para el control de la roya del cafeto, los basados en el cobre siguen siendo usados a gran escala. Sin embargo, se cree que pueden ser susceptibles de perfeccionamiento. La figura 8, Ocampo, Quijano-Rico (1980) muestra como un compuesto orgánico sencillo de cobre puede ser de 20 a 100 veces más activo que un compuesto inorgánico como esporostático. Por otra parte, se observa que el derivado organocúprico induce una inhibición del 95% a niveles de una parte por millón de cobre, mientras el cobre inorgánico requiere 100 veces más concentración para el mismo efecto. El hecho de que a concentraciones de 100 ppm el efecto inhibitor del cobre sea solamente del 95% demuestra que existe una fracción de la población de esporas que tiene resistencia natural al cobre. Dicha población puede incrementarse en la práctica con el uso de fungicidas cúpricos corrientes dando lugar al conocido fenómeno de resistencia. De acuerdo con la gráfica este no es el caso del compuesto orgánico de cobre en referencia, el cual a concentraciones de 2 a 3 partes por millón, produce una inhibición de la germinación del 100%. No nos extendamos más aquí sobre el tema bioquímico, en la sección de agronomía Sielke Sievers presentará un trabajo completo sobre investigaciones similares o complementarias.

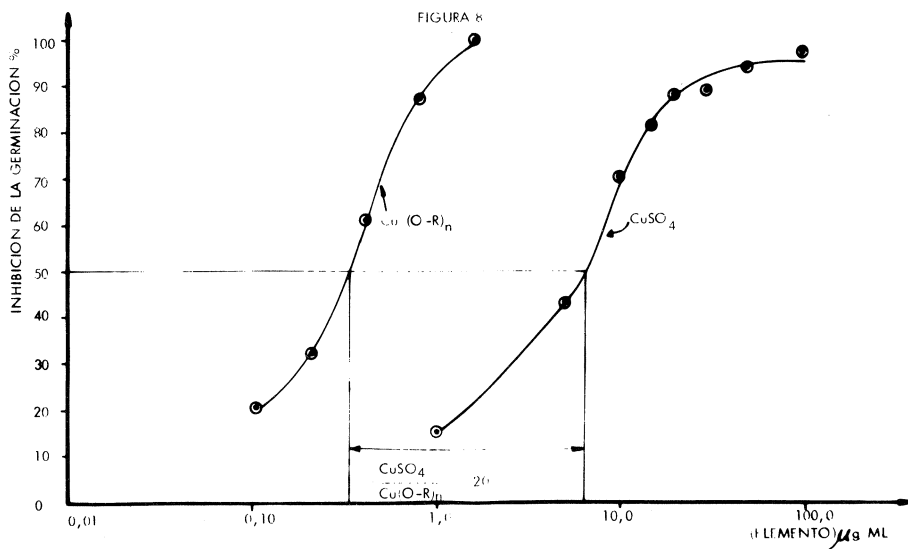
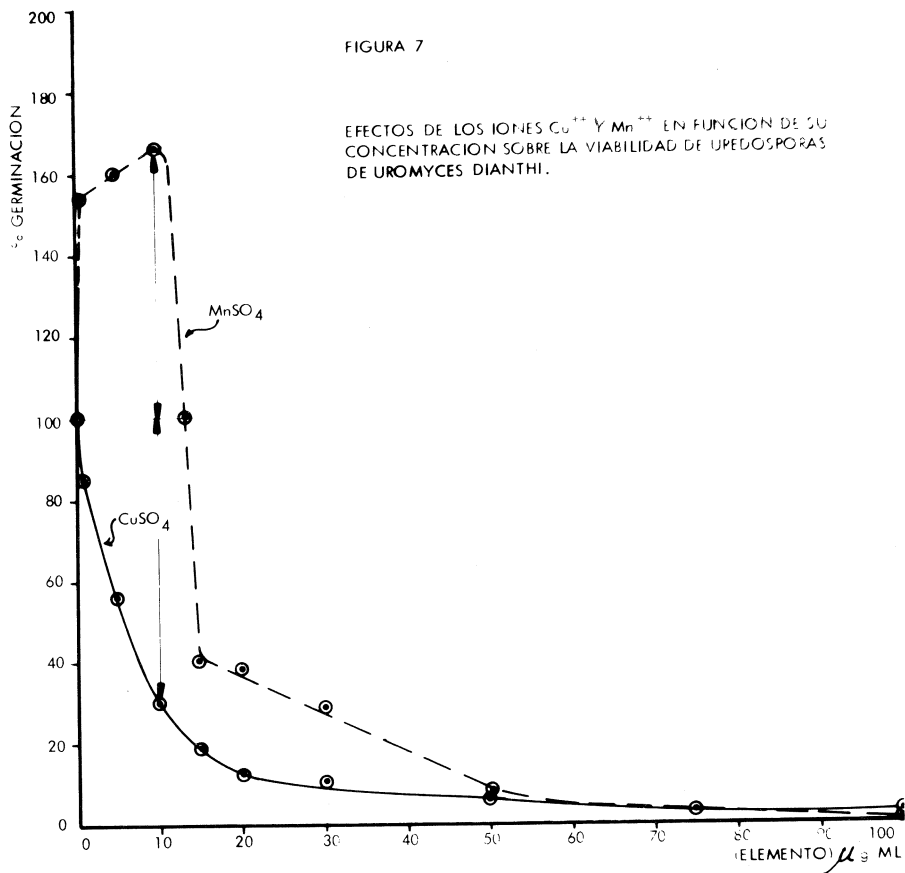

IMPORTANCIA DEL ESTADO QUIMICO DEL COBRE PARA SU ACTIVIDAD SOBRE LA VIABILIDAD DE UREDOSPORAS DE UROMYCES DIANTHI.

7.4 Investigación aplicada y desarrollo

En este campo están en curso varios trabajos sobre el procesamiento y conservación de cafés y de productos de café. Vamos a presentar aquí, lo realizado sobre la producción de cafeína a partir de granos de desperdicio de la agroindustria del café en Colombia. Las características principales del proceso son: utilización de cualquier tipo de desperdicio agrícola que contenga cafeína, granos defectuosos o inutilizables, pulpa del proceso por vía seca, residuos de té, etc., empleo de una planta móvil que se desplaza a los lugares en que se concentra la materia prima, autoabastecimiento de la planta en energía usando una parte de los residuos de separación de cafeína, producción de cafeína bastante pura.



Figura 9: Vista de conjunto de la miniplanta de separación de cafeína, LIQC.



Figura 10:

Vista del sistema de recuperación gas / sólido / líquido de la cafeína en la miniplanta del LIQC.

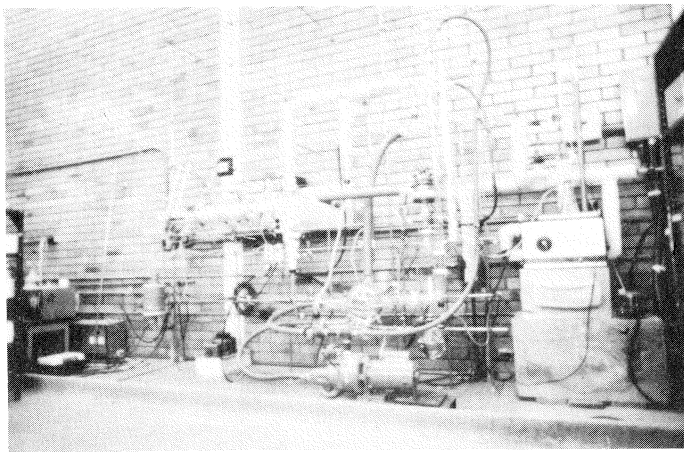
El proceso se desarrolló enteramente en nuestro laboratorio utilizando una miniplanta completamente diseñada y construida por nosotros, figura 9 y 10. Las figuras 11 y 12 muestran los primeros prototipos a escala de laboratorio. En la figura 13 se presentan las curvas de separación de cafeína de pulpas de café de Brasil y de Costa de Marfil por nuestro proceso. De la figura 15 se puede tener una idea de la configuración de la planta móvil.

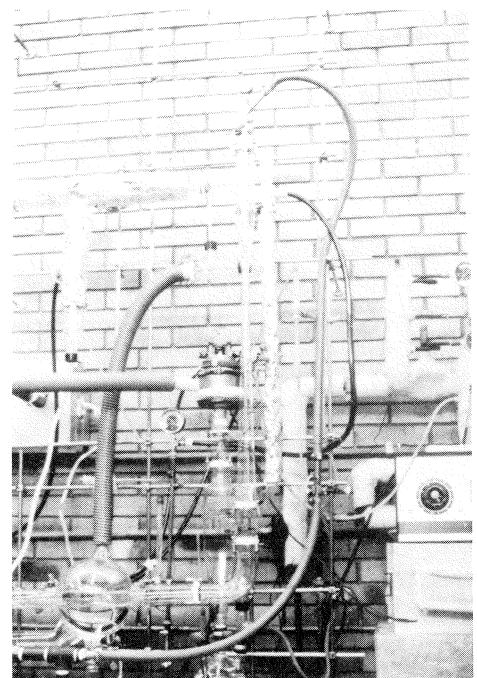

Figura 11: Primer sistema experimental para el estudio de la separación de la cafeína por el proceso LIQC, 1975.



Figura 12: Primera planta experimental de laboratorio para la separación y recuperación de cafeína por el proceso desarrollado en el LIQC, 1976.



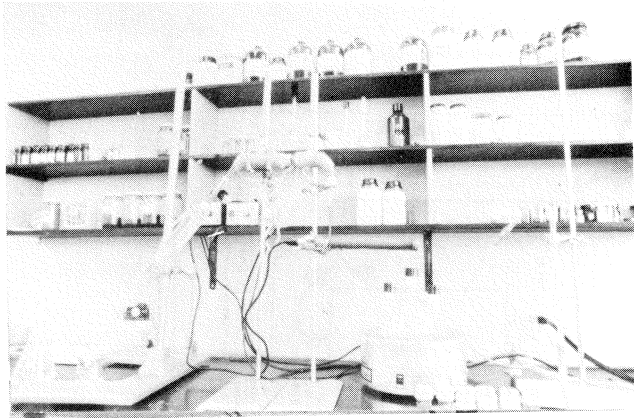

En la figura 16 se comparan las ventajas y desventajas de la planta móvil con una planta convencional fija.

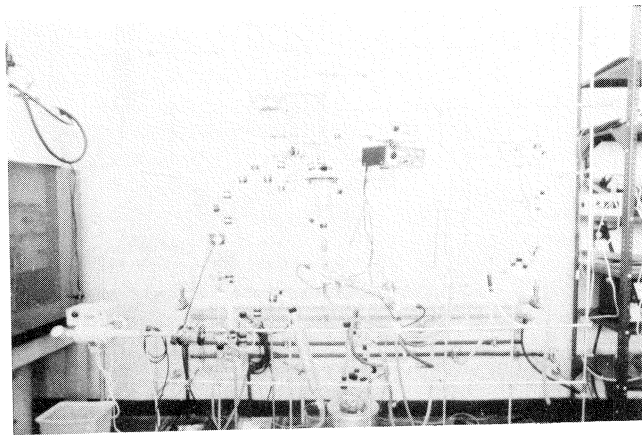
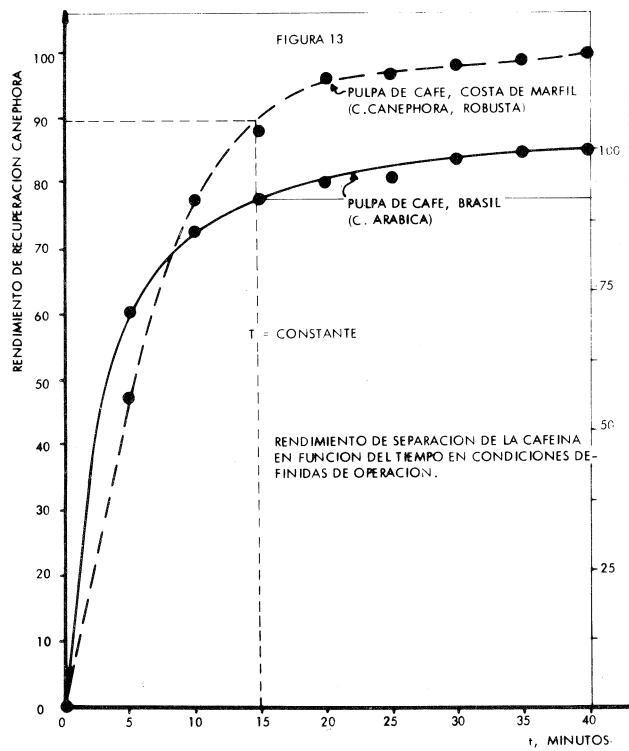
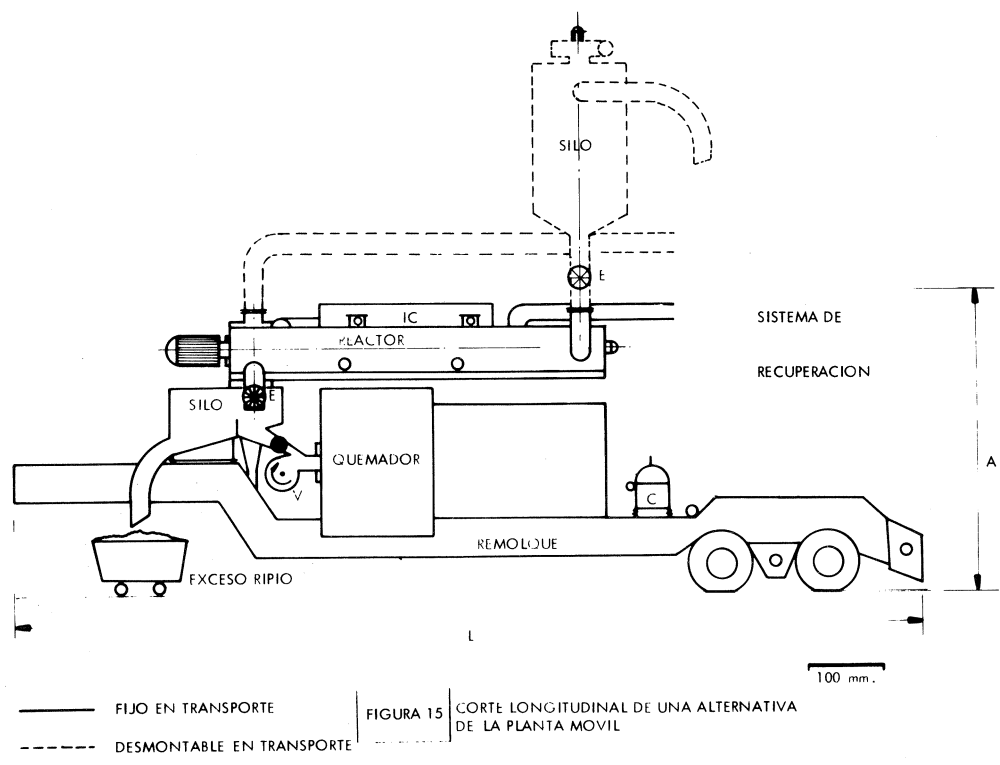
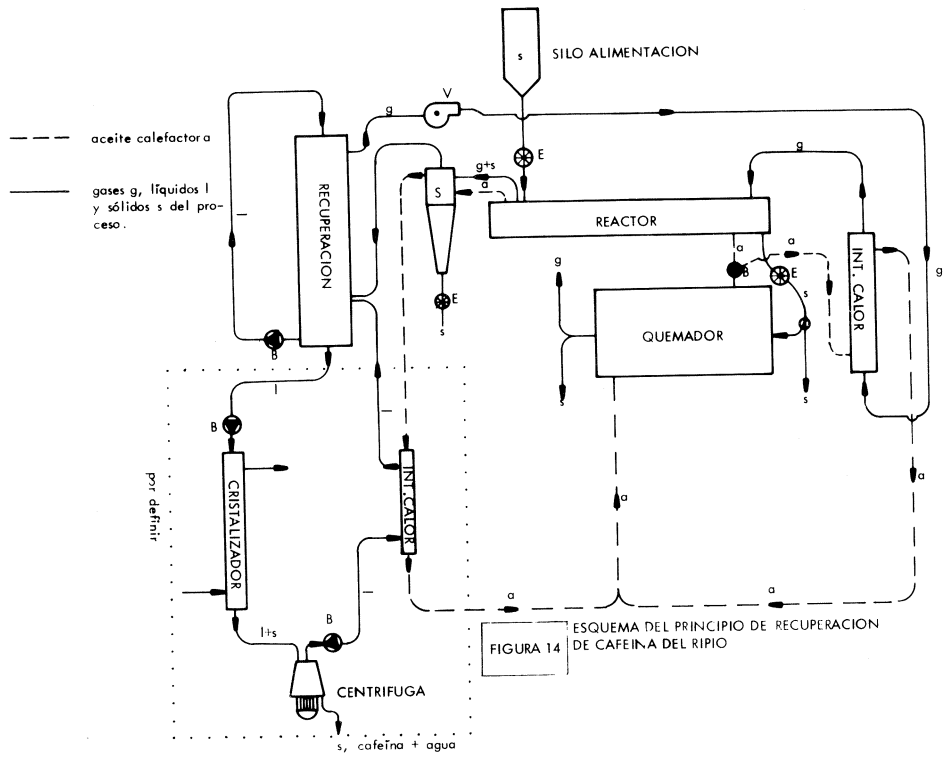
ALTERNATIVA 1			ALTERNATIVA 2			ALTERNATIVA 3
Planta situada en Medellín 4.306 ton. ripio			Planta situada en Armenia 2.262 ton. ripio			Planta móvil de 20 toneladas Salida: Bogotá
Ciudad	ton. ripio	Kms. hasta Medellín	Ciudad	ton. ripio	Kms. hasta Armenia	Recorrido
Pereira	1490	312	Pereira	1490	45	Girardot
Buga	1484	170	Buga	1484	190	Armenia
Armenia	2262	357	Medellín	4306	357	Buga
Girardot	531	477	Girardot	531	240	Pereira
Bogotá	735	562	Bogotá	735	326	Manizales
Honda	403	341	Honda	403	192	Medellín
Manizales	1039	252	Manizales	1039	104	Manizales
	7944	2821		9988	1454	Honda
						Bogotá

ripio a procesar = 12.250 ton. ripio a procesar = 12.250 ton. Ripio a procesar = 12.250 ton.

costo de transporte = \$ 14.435.510* costo de transporte = \$ 12.193.670* costo de transporte = \$ 143.400*

*Se supone un costo de 5,00 pesos/ton.- km. para el cálculo de estos costos.

COMPARACION DE LOS COSTOS ASOCIADOS CON EL TRANSPORTE DE DOS ALTERNATIVAS DE PLANTA FIJA CON LA PLANTA MOVIL

FIGURA 16

Figura 17: Costos de una planta para tratar 10.000 T/año de materia prima.

PROYECTO PLANTA PILOTO MOVIL PARA PRODUCIR CAFEINA DEL RIPIO		
1. Capacidad	10000 TMA/AÑO 50000 KG/AÑO	RIPIO A 100% CAFEINA PUREZA >95%
2. Precio de venta	603,0 pesos/Kg	(13,0 dólares EUA 5.1980/kg)
3. Materias primas	ripio 0,65%	contenido promedio cafeína
	0,77	rendimiento total recuperación
	200,0	Kg ripio/kg cafeína
	0,020	pesos/Kg ripio
	4,00	pesos, ripio/kg cafeína

EVALUACION DE COSTOS		pesos/año
Materias primas		200.000
Mano de obra		2.000.000
Mantenimiento		1.875.000
Servicios generales		2.277.000
Gastos generales planta		860.000
Amortización		4.638.000
Impuestos y seguros		666.000
Empaque		90.000
COSTOS DE PRODUCCION		12.426.000
Investigación		1.000.000
Gastos de ventas		100.000
Administración		1.020.000
Intereses		1.860.000
COSTOS TOTALES		16.586.000
Costos fijos		9.209.000
Costo fijo-amortización		4.571.000
Costos variables		7.377.000
		332,0 pesos/kg

EVALUACION DE LA INVERSION	
A) Directa fija (CIF Bogotá, arancel 40%)	37.500.000
B) Directa fija (CIF Bogotá, arancel 5%)	26.205.000
Capital de trabajo	1.000.000
Total fija (A)	38.500.000
Total fija (B)	27.205.000

RESUMEN	
Ventas netas	30.147.000
Costos	16.586.000
Beneficio, sin impuestos	13.561.000
con impuestos	13.561.000
Amortización	4.638.000

CRITERIOS DEL BENEFICIO		
	(A)	(B)
con impuestos		
(arancel 40%)	35,0	50,0
(arancel 5%)	2,1	1,5

Rendimiento %	
PRI, años	2,1

FIGURA 17

Figura 18: Como es evidente, los precios de costo dependen del contenido en cafeína de la materia prima. En el caso de los desperdicios de café de Colombia (ripio) el contenido de 0,65 conduce a un precio de costo global de 7.15 US/kg con una pureza $\geq 98\%$. Para una materia prima con 1,6% los costos se reducen a 5,50 US/kg. La rentabilidad es alta, usando el ripio colombiano cerca de un 50% con un período de recuperación de la inversión de 1,5 años. Una planta experimental para tratar 10.000 T/año y producir 50.000 Kg de cafeína debe funcionar en los primeros meses de 1981, Quijano-Rico (1980).

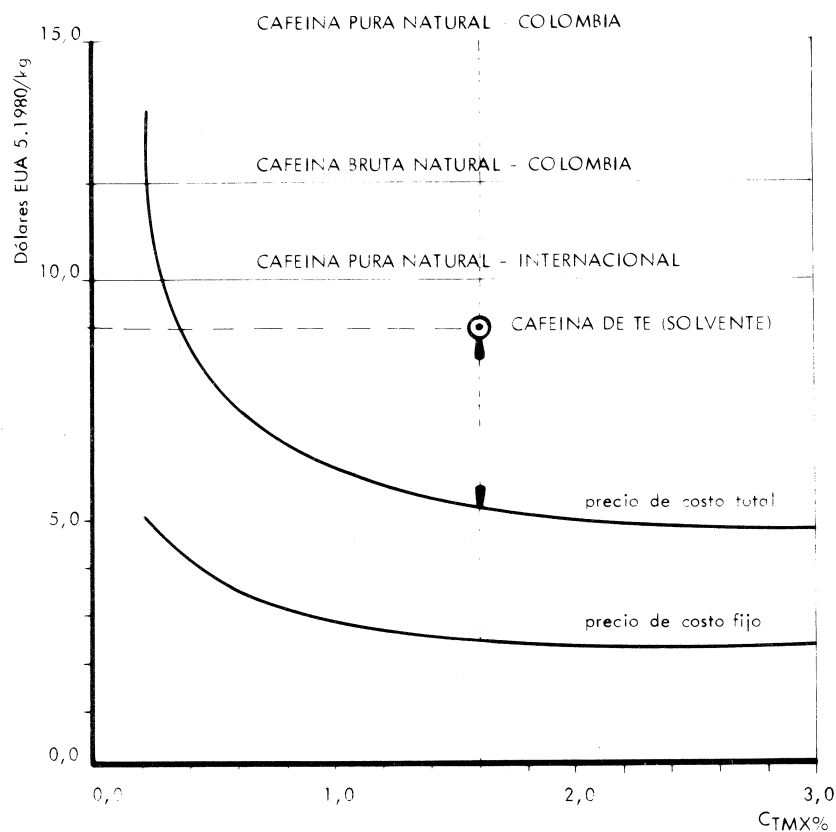

El precio de costo por Kg de cafeína en función de su contenido, CTMX en la materia prima. Planta de 10.000 T/año a 100% de la capacidad, $\eta_{RT} = 0,7$.

FIGURA 18

Señoras y Señores: hace hoy siete años, con ocasión del 60. Coloquio Internacional de la ASIC en Bogotá, decíamos: "Quisiéramos que el 60. Coloquio contribuya como los anteriores al mejor conocimiento científico del café. Que facilite el contacto entre sus estudiosos y el acceso a las técnicas investigativas más modernas y a las informaciones más recientes. Que simultáneamente sea un vector de progreso: para la toma de conciencia de la importancia de la investigación científica por parte de los países productores; para una mayor colaboración en la investigación científica entre países más y menos desarrollados", Quijano-Rico (1973)c.

De la receptividad de las altas directivas de la Federación Nacional de Cafeteros de Colombia y del esfuerzo y entusiasmo por la Ciencia y la Tecnología del café de los pioneros, R. Coste y E. Illy, de la Asociación Científica Internacional de Café para los países productores y consumidores, surgió

la experiencia de nuestro laboratorio, para ellos consigno en nombre de mis colaboradores y mío propio mis mejores agradecimientos, lo mismo que para todos quienes nos han prestado su colaboración: Instituto Max Planck para la Química e Instituto de Química Nuclear de la Universidad J. Gutenberg, Mainz, Instituto Francés del Café y del Cacao, París, Sociedad Alemana de Cooperación Técnica, Eschbom, Instituto de Investigaciones Tecnológicas, Bogotá.

Espero no haberlos fatigado demasiado y que esta presentación contribuya a estrechar lazos fértiles de cooperación Norte-Sur, en el campo más sensible, Ciencia y Tecnología . . . alrededor del estimulante efecto de un siempre mejor café, meta de nuestro esfuerzo.

Mil gracias.

REFERENCIAS

- Gómez-Jaramillo, A.: Cincuentenario de la Fundación de la Federación Nacional de Cafeteros de Colombia, Medellín, Junio de (1977) discurso.
- Smookler, J.: *Invention and Economic Growth*, Harvard University Press, Cambridge, Mass.(1966).
- Jenner, R.A.: An Information Version of Pure Competition, *Economic Journal* 76, 786-805 (1966).
- Eigen, M., Winkler, Ruthild: *Das Spiel*, Piper Verlag, Munich, (1978).
- Sagasti, F.: Underdevelopment, Science and Technology, The Point of View of Underdeveloped Countries, *Science Studies*, 3, 47-59 (1973).
- Illy, E.: Ensayos no publicados sobre el flujo de la información y el crecimiento del bienestar, Trieste, (1979).
- Quijano-Rico, M.: (1974) Presentación del Laboratorio de Investigaciones sobre la Química del Café y de los Productos Naturales de la Federación Nacional de Cafeteros de Colombia, *Química e Industria* (Bogotá) 8, 21-34.
- Gasparini, Olga: (1969) *La Investigación en Venezuela, Condiciones de su Desarrollo*, Cromotip, Caracas.
- Gee, Sh: (1975) Foreign Technology and the United States Economy, *Science*, 187, 622.
- Carey, W.D.: (1978) Science and Technology for Development, *Science* 199, 1.
- LIQC (1980), *Investigación Fundamental y Aplicada en el LIQC desde su creación hasta hoy/Fundamental and Applied Research at the LIQC, since its creation until today.*
- Bautista, E., Chaparro F., Moreno E.: (1980) Identificación de algunos volátiles de extractos de café y determinación de las condiciones para su cuantificación, LIQC, Bogotá.
- Jaramillo, J.I.: (1980) Retención de aroma durante la liofilización, Tesis, U. Nacional, LIQC, Bogotá.

- Posada E., Jaramillo, J.I., Bautista, E., Moreno, E., Ablanque E., Chaparro, F., Castaño, J., Castellanos, C., Ortiz, A., Franco, M.: (1980) Evolución del contenido de volátiles durante el procesamiento de extractos de café, LIQC, Bogotá.
- Bautista, E., Moreno, E., Ablanque, E.: (1980) Sistema de concentración de volátiles para el análisis de hojas de cafeto, LIQC, Bogotá.
- Ortiz, A., Riaño, C.E., Chaparro, F., Posada, E.: (1980) Determinación de características físicas de extractos de café, LIQC, Bogotá.
- Gutiérrez, Juana, Quijano-Rico, M.: Encuentro de Inter-Información MPI-Ch (Instituto Max Planck para la Química, Mainz, Alemania, R.F.) - LIQC, Bogotá, (1979).
- Chaparro, F., Posada E., Spettel, B., Gutiérrez, Juana, Quijano-Rico, M.: (1979) Análisis multielemental por activación con neutrones térmicos y espectroscopía de emisión óptica de hojas de cafetos de diferentes especies y variedades, MPI-Ch y LIQC.
- Quijano-Rico, M.: (1977) New Trends in research for the protection of the coffee plant against coffee rust, Pontificiae Academia Scientiarum, Scripta Varia, 41, Ciudad del Vaticano, 29-33.
- Quijano-Rico, M.: (1978) The Scientific Research Program of the LIQC on the so-called Coffee Rust Disease, Coffee Rust Control, Report for a Seminary held in Paipa, Colombia, GTZ, Eschborn, RFA 306-310.
- Quijano-Rico, M., Spettel, B.: Determinación del contenido en varios elementos en muestras de cafés de diferentes variedades, ASIC, 7o., Coloquio, Hamburgo, (1975) 165-174.
- Hughes, M.N.: (1972) The inorganic Chemistry of Biological Processes, John Wiley Sons, Londres.
- Ocampo, C., Bravo, Isabel, Zamudio, V., Quijano-Rico, M.: (1980) Estudio de la penetración del cobre de fungicidas cúpricos, orgánicos e inorgánicos en esporas de la roya del clavel (*Uromyces dianthi*), LIQC, Bogotá.
- Bautista, E., Haverkamp, J., Wieten, G.: (1979) Posibilidades de la pirólisis espectrometría de masas para el establecimiento de correlaciones genética vs química en hongos y cafetos, FOM-Instituto para la Física Atómica y Molecular, Amsterdam, y LIQC, Bogotá.
- Quijano-Rico, M.: (1980) Rentabilidad de la planta piloto productiva móvil para la recuperación de cafeína a partir de desperdicios agrícolas, LIQC, Bogotá.
- Landau, E.: (1971) Psychologie der Kreativitaet, Munich/Basilea.
- Quijano-Rico, M.: (1973)a., El sistema de cromatografía de gases-espectrometría de masas-tratamiento automático de datos para el LIQC, Bogotá.
- Quijano-Rico, M.: (1973)b., Algunos temas de investigación básica orientada y/o aplicada para la estructuración de los programas de investigación del LIQC, Bogotá.
- I. Bravo, M. Quijano-Rico (1980), Estudio de la interacción entre el cobre y el manganeso sobre la viabilidad y toma de cobre por esporas de *Uromyces dianthi* (roya del clavel).
- Moreno, E., Ablanque, E., Bautista, E., Sievers, Sielke: Compuestos volátiles en hojas de cafetos y su papel en la interacción con patógenos.
- Quijano-Rico, M. (1973)c., La idea que nos hacemos del 6o. Coloquio, LIQC, Bogotá.

NEW TRENDS IN THE PHARMACOLOGY OF CAFFEINE



R. PAOLETTI, S. CANTALUPPI

Institute of Pharmacology and Pharmacognosy

University of Milan, 20129 Milan, Italy

Caffeine represents a typical example of a stimulant selected by man and used in self-medication. Until very recently no clear definition of its mode of action was given to justify its pharmacological effects.

During the development of civilization man found and recognized different types of natural sources of methylxanthines: the coffee beans in Arabia, the tea leaves in China, the Kola nuts in West Africa, the cocoa beans in Mexico, the Ilex plant providing maté and the Paullinia seeds providing guaraná in Brazil, and Cassina in North America.

It has been recognized already a century ago by the English scientist Bentley (1) that it was "most remarkable that all the most important unfermented beverages in use in different parts of the globe should be prepared from substances containing the same or a closely allied alkaloid".

The consumption of caffeine is always growing as will be discussed during this conference. Table n. 1 shows the range of caffeine concentrations found in dietary sources.

Tab. 1 RANGES OF CAFFEINE CONTENT IN DIETARY SOURCES

Brewed coffee	1 cup	75 - 150 mg
Instant coffee	1 cup	60 - 99 mg
Decaffeinated coffee	1 cup	2 - 4 mg
Leaf tea	1 cup	60 - 100 mg
Instant tea	1 cup	30 - 35 mg
Cocoa	1 cup	6 - 42 mg
Cola drinks	10 oz.	25 - 60 mg

The average daily consumption of caffeine in U.S. is about 200 milligrams per person, including children (2). Twenty to 30% of Americans take 500-600 mg a day, 10% may exceed 1 g of caffeine a day (3). In Scandinavia, Belgium and Australia the average citizen consumes 14 to 27 pounds of coffee a year, against an average of 12.43 pounds in U.S. (4). Non-prescription medicines may contain 15 to 30 mg of caffeine per tablet (5). Children consume caffeine mostly in the form of soft drinks containing about 30-60 mg of caffeine in a typical portion (0.01-0.02%) (Tab. 2). A can of soft drink for a very young child may well represent the equivalent of four cups of instant coffee for an adult (6).

Tab. 2 ESTIMATED DAILY INTAKE OF CAFFEINE (5)

Age	Total Person-Days Surveyed	Mean Intake mg/day	99th Percentile mg/day	Eaters only	
				Mean Intake mg/day	% of Total Person-Days
6-11 months	1274	4.2	111	77	6
12-23 months	2548	15	133	49	30
2- 5 years	12628	29	211	70	41
6-17 years	40726	43	323	101	43
18 + years	114618	186	563	227	82
Pregnant	1078	144	676	193	74

This widespread use of caffeine opens several questions: what are the pharmacological effects of caffeine, particularly in the central nervous system, what is its mode of action, and is caffeine, at the doses commonly used, toxic for man?

CENTRAL PHARMACOLOGICAL EFFECTS AND DISTRIBUTION OF CAFFEINE

Caffeine, after ingestion, is rapidly absorbed and distributed in the whole organism in proportion to the tissue water content. After ingestion from food or beverages it produces a variety of biological effects: diuresis, cardiac muscle and central nervous system stimulation, smooth muscle relaxation, stimulation of gastric acid secretion, elevation of the plasma levels of free fatty acids and glucose.

The usual pharmacologically active dose of caffeine is 200 mg, the amount present in two cups of ground coffee or four cups of instant coffee.

In comparison with other methylxanthines caffeine is preferred as a cerebral and respiratory stimulant, theophylline from tea as a vasodilator and theobromine from cocoa as a diuretic (7). Caffeine is also the most active skeletal muscle stimulant among the three methylxanthines.

Caffeine is not an adaptive drug: regular consumption is in fact unable to reduce its stimulant effects on the central nervous system.

The cortex is first affected and then the medulla, with the respiratory, vasomotor and vagal centers, while the spinal cord is stimulated only by much larger doses (8). A keener appreciation of sensory stimuli occurs, together with a decrease of the reaction time and an increase of motor activity.

In human double blind experiments caffeine has been shown to prevent attention lapses after the first hour, an effect persisting for 2-3 hours. Physical tasks involving speed are generally improved (9,10).

Elkins and Rapoport (11) have carried out a double blind study in prepubertal boys with a mean age of 10.6 years, using placebo or caffeine, 3 mg/kg or 10 mg/kg. The test battery, including Reaction Time, Continuous Performance Test, Memory and (trunkal) Motor Activity, indicated an increased motor activity and vigilance, as shown by two

independent measures, induced by the higher dose of caffeine.

The substance is mildly physically addictive, the best demonstrated withdrawal symptom being a headache resistant to prostaglandin inhibitors such as acetylsalicylic acid and acetaminophen. The withdrawal headache occurs 18 to 24 hours after the last dose of caffeine (3).

The need for repeated, daily oral administrations of caffeine in order to assure central stimulating effects, may be explained by its rapid metabolism and excretion from the human organism. Peak plasma levels (3-10 microg/ml) are reached within an hour after oral administration (12) and the absorption is even more rapid after oral than after intramuscular administration (13).

In rodents and non-human primates the absorption following oral administration is also quite rapid (Tab. 3) (14).

Tab. 3 BLOOD PLASMA VALUES IN FOUR SPECIES FOLLOWING ORAL ADMINISTRATION OF 25 mg/kg CAFFEINE-1-¹⁴C. (14)

	Rat	Hamster	Rabbit	Rhesus monkey
Half-life (hr)				
Radioactivity	5.4	3.5	11	19
Caffeine	2.8	3.1	3.7	2.8
Absorption half-time (hr)				
Radioactivity	0.1	0.5	0.7	0.9
Caffeine	0.1	0.1	0.7	
Peak plasma concentration of caffeine (mg/l)	18	18	22	13

The plasma concentration has a rapid decline by biotransformation *in vivo*, with a half-time averaging 3.1 hours (range 2.3-4.5 hours) in man and dogs (15). The main metabolites formed are paraxanthine (1,7-dimethylxanthine), 7-methylxanthine, and 1-methyl-xanthine which is further transformed into 1-methyluric acid (14) (Fig. 1).

Fig. 1 CAFFEINE METABOLISM IN MAN (14,21)

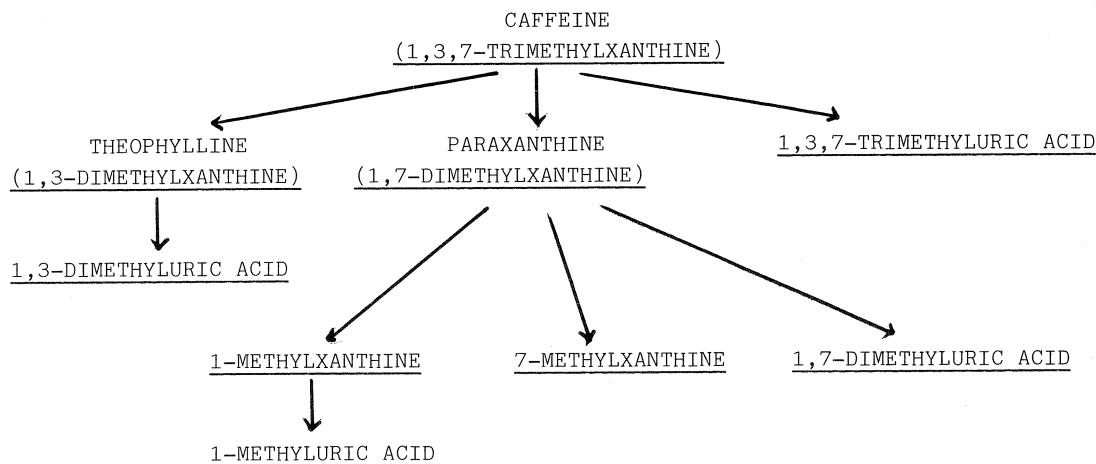

Plasma and brain concentrations have been measured in rats by Latini *et al.* (16) after 3 different oral doses (3, 10 and 100 mg/kg) showing apparent dose-dependent kinetics of absorption and metabolism. The peak plasma levels are reached 5 minutes after the 3 mg/kg dose and 30 min. and 4 hrs respectively after the higher doses.

Half-lives ($t_{1/2}$) are similar for plasma and brain at the lowest dose, while at 10 mg/kg the $t_{1/2}$ in brain is higher than in plasma.

Quantitative data on the demethylation process of caffeine in man have been recently obtained by Arnaud and Thelin (17) using ^{13}C -labelled caffeine in human volunteers. Ten per cent of the methyl groups of caffeine were found in expired CO_2 6 hrs after caffeine administration.

The rapid distribution of caffeine is also observed in pregnant animals. There is little placental barrier in rats (18) (Tab. 4) and the equilibration of caffeine between plasma and fetus has been confirmed in man (19).

Tab. 4 MATERNAL-FETAL DISTRIBUTION OF CAFFEINE IN RATS (18)

Time (hr)		Concentration (mg/kg)			
		Plasma	Brain	Heart	Liver
1	Maternal	31	19	24	26
	Fetal	29	19	21	24
2	Maternal	23	16	19	21
	Fetal	21	15	17	19
4	Maternal	20	13	15	19
	Fetal	19	13	14	17
$t_{1/2}$ (hr)	Maternal	4.8	5.6	4.6	7.0
	Fetal	5.2	5.7	4.8	6.8

Tab.5 TOTAL RADIOACTIVITY (DPM/g FW) IN FETAL AND MATERNAL BRAINS AND LIVERS AT VARIOUS INTERVALS AFTER THE i.m. INJECTION OF 1-METHYL ^{14}C CAFFEINE (10 μC) INTO THE MOTHERS (20)

		BRAIN				LIVER			
		1 hr	2 hr	4hr	8 hr	1 hr	2 hr	4 hr	8 hr
MOTHER	A	20230	21323	14369	5756	24642	30945	27289	12941
	B	21911	21743	10000	7059	29272	29663	20525	18235
FETUS (pooled tissues)	A	20713	26428	18991	14076	21575	24243	21092	6827
	B	28318	23171	13382	15840	22562	18739	14159	9874
FETUS/ MOTHER RATIO	A	1.02	1.24	1.32	2.44	0.87	0.78	0.77	0.53
	B	1.29	1.07	1.34	2.24	0.77	0.63	0.91	0.54

Investigations in our laboratory indicate an accumulation of labelled caffeine, injected intramuscularly to pregnant rats, into the fetal brain, suggesting long-lasting pharmacological effects (20)(Tab. 5).

More recent data by Arnaud and Bracco (21) show that not only caffeine, but also its metabolites are present in the fetal tissues, possibly through transplacental acquisition, and that newborn rats are able to metabolize caffeine to paraxanthine, theophylline, trimethyluric acid and to unknown polar compounds with 1-methyl-uric acid. Compared to the human newborn the maturation of the metabolic pathway of caffeine in the rat seems more rapid (22).

Neims (23) has investigated the metabolism of caffeine in pregnant women and infants showing that catabolism is slowed in pregnancy and in neonates. The average suckling infant of a caffeine-consuming mother would reach a maximal steady-state plasma concentration of caffeine of less than 2 mg per liter at the age of 3 to 6 weeks. No serious side-effects have been shown in newborn exposed to prolonged high plasma levels of caffeine for the treatment of premature neonatal apnea (24). The rate of caffeine metabolism reaches adult values during the first year of age.

TOXICOLOGY OF CAFFEINE

The property of caffeine to cross the placental barrier and to be slowly metabolized by fetal tissue has raised the question whether the consumption of caffeine during pregnancy may have adverse effects on the offspring. In addition the widespread and continuous use of caffeine, a drug with powerful pharmacologic effects has also raised the possibility that this compound may have long-lasting side effects including carcinogenicity.

Mutagenicity

Caffeine has been established as weakly mutagenic in microorganisms, plants, insects and some mammalian cells in culture, at doses of 500-2000 mg/l (25). These concentrations are far in excess of the exposure which is likely to be experienced by human consumers of caffeine containing beverages (that exposure being ca. 10 mg/l or $5.2 \cdot 10^{-5}$ M) (26).

In cultured mammalian cells the main effects of caffeine at high dosage are to induce chromosomal aberrations and breakages and to interfere with DNA repair mechanisms.

Despite these findings in vitro, investigations in vivo have failed to demonstrate mutagenic effects of caffeine. Caffeine has been considered non-mutagenic in the dominant lethal test in mice (27) at doses of 4 to 122 mg/kg/day in drinking water, and in rats at doses of 200 mg/kg/day.

Negative results have also been obtained in other, possibly more sensitive assays, such as the micronucleus assay and the abnormal sperm assay (29).

Extrapolations from in vitro and from animal studies are always dangerous, due to problems of inter-species comparison, nevertheless it seems that the risk of caffeine-induced mutations in man is very low, even if worthy of further investigation.

Carcinogenicity

Long-term studies of the effects of caffeine or coffee consumption (as drinking fluid or in the diet) have failed, with one exception, to show a positive correlation between caffeine intake, in doses up to 200 mg/kg/day for 2 years, and the incidence of neoplasms (30,31, 32). In fact in one study (31) the incidence of neoplasms was reduced in the groups treated with high caffeine dosages with respect to control groups.

The exception to these negative findings is the first, unpublished, study of Takayama presented at the ILSI 1st Caffeine Workshop (33). Wistar rats (housed five per cage) were given 0.1% or 0.2% caffeine solutions as only drinking fluid; they showed a

significant increase in endocrine tumours compared to controls given tap water.

There was no dose-response relationship and the incidence of these tumours in the control animals was unusually low. Besides the importance of checking the diet for mutagenic or carcinogenic contaminants, and of measuring corticosteroid levels, which are affected by the number of animals per cage, has been stressed during the Workshop.

The study has been repeated, but details of the results have not been published yet; preliminary findings show no remarkable toxic effects in the caffeine-treated groups (34).

Mohr has undertaken a companion study to the one by Takayama, in which SPF (barrier maintained) rats are given caffeine in drinking water at concentrations between 0.02 and 0.2%. There are 50 males and 50 females per treatment and a double control group, scheduled to be studied for up to 30 months, plus three satellite groups (10 per sex per treatment) which are sacrificed at 3, 6 and 12 months. The interim report (35) on this study does not show evidence of carcinogenicity of caffeine, even if at the highest dosage level rats show depressed body weight and reduced food and fluid intake.

Caffeine has been shown, on the other hand, to have mild protective effects on the carcinogenicity of ultraviolet light, 4-nitroquinoline-1-oxide and skin painting with tobacco smoke condensates (36,37,38).

As regards the human epidemiologic studies results are inconclusive. A low-strength correlation has been shown to exist between coffee drinking and cancer of the lower urinary tract (LUT) and renal pelvis (39,40,41,42). No dose-response relationship has been found though, and the correlation is higher for women than for men in one study (39) and for men than for women in another (41).

These studies have taken into account the interference of such factors as smoking, occupation and dietary factors, but a comprehensive prospective study is still missing.

It must be noticed that Simon (40) did not find any correlation between tea drinking and bladder cancer even though the caffeine content of a cup of tea and a cup of coffee are not much different; while the association between coffee drinking and disease did not change when decaffeinated instead of non-decaffeinated coffee was utilized. Thus, if there is a carcinogenic effect of coffee, this is probably not due to caffeine but rather to the phenolic component of chlorogenic acid, a very soluble component of coffee, which has been shown to augment human exposure to the carcinogenic N-nitroso amines by catalyzing their formation in the intestinal tract (43).

Teratogenicity and effects on reproduction

Caffeine, as already discussed, is known to cross the placental barrier freely: the studies conducted by Horning *et al.* show that all neonates excrete caffeine in the urine during the first days after birth and therefore have all been exposed to caffeine while in utero (44).

Sieber and Fabro (45) have demonstrated the presence of caffeine in the pre-implantation blastocyst and in the uterine secretion when 6-day pregnant New Zealand white rabbits were given 3.5 mg 1-methyl¹⁴C-caffeine per kg body weight, by gavage.

Several teratology studies on caffeine published in the past twenty years have been recently reviewed by Collins (46).

Caffeine has been shown to be embryotoxic and teratogenic when injected i.p. in mice at doses varying between 25 and 250 mg/kg.

The oral administration by gavage of caffeine solutions to mice and rats gives different degrees of positive correlations with fetal loss and resorption and with skeletal defects (cleft palate, delayed ossification). In general with doses under 50 mg/kg few or no frank terata are recognized, whereas doses over 75-100 mg/kg give rise to increased number of malformations and fetal losses.

When the animals receive caffeine in the diet or in drinking fluid (as caffeine solutions or diluted coffee) the results are similarly indicative of a teratogenic potential of caffeine at doses exceeding 38 mg/kg/day.

Some studies which have positive and some which have negative results could be considered invalid though, due to small number of animals, lack of proper controls and insufficient information. The difference in results may also be due to species and strain differences, source of caffeine, route administration and duration of ingestion. In particular it appears that an acute high dose of caffeine, given by injection or gavage, is more teratogenic than the same dose administered in drinking water (47).

Recent studies by Sullivan et al. on mice given caffeine in drinking water or in sustained release pellets have shown that the retarded ossification of supraoccipital bones observed in neonatal mice from dams given high doses of caffeine during pregnancy, may be due to a reduced food and water intake of the caffeine-treated dams. The animals given the pellets have sustained high blood levels of caffeine and their pups have a reduced weight compared to controls, but they show no increase in congenital malformations. All caffeine treated animals present high plasma corticosteroid levels.

Most interesting in this respect should be the results (still not released) of the experiments conducted by Collins, whose schedule included treatment of Osborne Mendel rats on days 0-19 of gestation, with doses of caffeine ranging from 6 to 125 mg/kg/day by oral intubation or with solutions of caffeine in distilled water of 0.005% to 0.1% as drinking fluid (equivalent to approximately 6 to 144 mg/kg/day).

Observations to be made concern number and position of resorption sites and fetuses (dead or alive), sex and number of normal and abnormal fetuses and then visceral and skeletal examinations.

Another recent study by Sobotka et al. (49) has shown that exposure of rats to drinking water containing 0.0125, 0.125 or 0.05 per cent of caffeine during pregnancy and lactation has no apparent effect on the physical development and viability of the neonates, but induces behavioural changes (heightened exploratory activity and altered performance in a progressive fixed ratio schedule) in the post-weanling adolescents.

The human studies on the possible teratogenic effect on caffeine are limited to retrospective studies. Nelson and Forfar on a study of 1369 mothers, did not find an association between caffeine self-administration and abnormalities in offspring.

Heinonen (51) found no evidence of the teratogenic activity of caffeine in 12700 mothers who consumed caffeine during pregnancy.

Weathersbee et al. have observed, on the contrary, that an excessive (over 600 mg/day) ingestion of caffeine by pregnant women may have an effect on the outcome of pregnancy with a higher incidence of abortions and prematurity. The same study also indicates similar results if the male member of the household consumes large quantities of coffee.

In a recent more speculative paper, Weathersbee and Lodge (53) suggest possible mechanisms of action of caffeine at the fetus level, including massive release of catecholamines (54), disruption of the normal functioning of the feto-placental unit (55) and alteration of the fetal levels of cAMP, this in turn affecting many of the cellular processes. Some of these findings however may be challenged by the more recent studies indicating a more likely site of action of caffeine on the adenosine receptor, rather than directly on the cAMP system.

THE MODES OF ACTION OF CAFFEINE

The methylxanthines are inhibitors of the enzymes phosphodiesterases responsible for the inactivation of the intracellular second messengers of the hormonal stimulation (cAMP and cGMP) (56) as discussed in detail in a previous report from our laboratory (57). The phosphodiesterase inhibition is certainly important to explain many pharmacological effects of caffeine, but it hardly explains its preferential central effects and the cerebral vasoconstriction. In addition it must be noted that therapeutically relevant concentrations of theophylline barely affect phosphodiesterases and that

caffeine, a less potent phosphodiesterase inhibitor than theophylline, is more active on the central nervous system.

Recent investigations have determined that the methylxanthines have opposite effects to endogenous adenosine at different levels (58) (Tab. 6).

Tab. 6 SOME EFFECTS OF METHYLXANTHINES AND ADENOSINE (58)

<u>Methylxanthines</u>	<u>Adenosine</u>
Enhanced lipolysis in adipose tissue.	Inhibited lipolysis.
Increased renal blood flow and renin release.	Decreased renal blood flow and renin release.
Increased release of catecholamines.	Decreased release of catecholamines.
Increased heart-rate and force of contraction.	Decreased heart-rate and force of contraction.
Inhibited anaphylactic bronchoconstriction.	Enhanced histamine release.
CNS activation. Decreased cyclic-AMP.	CNS depression. Increased cyclic-AMP.

The structural analogy of adenosine and caffeine is also evident (Fig. 2)

Fig. 2

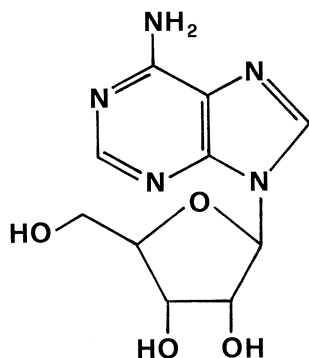

A d e n o s i n e

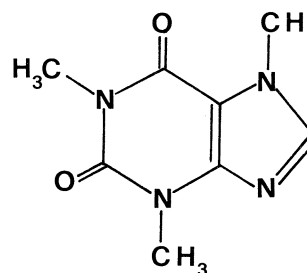

C a f f e i n e

Daly and Bruns (59) and Snyder (60) have recently indicated that caffeine inhibits phosphodiesterases at the high concentrations of 500-1000 microM, normally not found in human tissues, whereas it acts as an antagonist of the adenosine receptor in brain at the concentrations of only 10-30 microM. The central effects of adenosine, a modulator with depressant, hypnotic and anticonvulsant properties, are fully antagonized by caffeine. The caffeine-adenosine hypothesis is supported by the correlation between the relative potencies of a series of alkylxanthines, including caffeine, theobromine and 8-phenyltheophylline with regard to behavioural, biochemical and electrophysiological actions, and adenosine antagonism (59, 60).

The frequent findings that in some tissues (particularly in CNS) cAMP levels decrease after treatment with methylxanthines (61), are clearly explained by the inhibiting activity of these compounds on the adenosine-sensitive adenylate cyclase (62). Theophylline antagonizes the depression of spontaneous firing of corticospinal neurons by cAMP and 5'-AMP (63).

Morphine can release adenosine, the actions of which are antagonized by the methylxanthines (58). Moreover the depressant and central vasodilating actions of adenosine are documented and may well explain the opposite effects of caffeine, particularly on headache.

The interaction caffeine-adenosine is not present only in the CNS, but it may account for many peripheral actions of caffeine as well. Lipolysis is stimulated in adipose tissue by catecholamines through cAMP formation, an effect potentiated by methylxanthines but not by other phosphodiesterase inhibitors (64). Theophylline at least has been suggested to inhibit the antilipolytic action of endogenous substances, chiefly adenosine, and the effects of theophylline are mimicked by adenosine-deaminase (65).

Adenosine inhibits cAMP formation and lipolysis at a concentration of 0.1 μ M. Adenosine inhibits sympathetically stimulated lipolysis, and sympathetic stimulation of adipose tissue increases the release of purines, including adenosine, an effect inhibited by alpha-receptor blockade. Drugs known to inhibit adenosine uptake into cells, such as dipyridamole, increase plasma levels of adenosine and inhibit lipolysis induced by nervous stimulation (64), but do not affect lipolysis in the absence of adenosine. Alpha-receptor blockade, by eliminating adenosine release, potentiates lipolysis induced by sympathetic stimulation (64).

Adenosine enhances the actions of insulin on adipose tissue, as regards glucose uptake and lipolysis. The finding that caffeine inhibits insulin action in several tissues may partly be due to the elimination of the adenosine effect (65).

In the kidney caffeine induces a rapid increase of diuresis, due to an enhanced glomerular filtration rate, secondary to an increased blood flow (8). This effect is probably not related to an increase of cyclic AMP, because exogenous cAMP induces kidney vasoconstriction (66,67,68). Adenosine, present in the kidney at concentrations of 3-6 nmol/kg, is a potent vasoconstrictor, and its effect is completely antagonized by theophylline, thus fully explaining its pharmacological action on renal blood flow as an antagonism to endogenous adenosine.

After a brief period of ischemia the kidney of several mammalian species shows an increase in the outflow of adenosine, while the organ exhibits a post-ischemic reduction of blood flow which is antagonized by low doses of methylxanthines (69).

The release of adenosine is enhanced by noradrenaline (NA) and by sympathetic nerve stimulation, an effect antagonized by methylxanthines, but not by other inhibitors of phosphodiesterases (66).

Adenosine is a potent inhibitor of NA and acetylcholine release from nerve endings in a variety of tissues, another effect antagonized by theophylline and caffeine (66). The increased catecholamine release following caffeine administration may be due to antagonism of endogenous adenosine acting as a presynaptic inhibitor of transmitter release (70).

In the heart the sympathetic nerves have presynaptic adenosine receptors (66). The local release of catecholamines in the heart, induced by caffeine may be related to an antagonism of adenosine. Adenosine in the heart exerts negative inotropic and chronotropic effects and reduces the contractile effects of catecholamines on the myocardium (70). The opposite effect of caffeine is probably related to inhibition of adenosine receptors on the myocardial cell surface.

Similar potentiating effects on adrenergic stimulation can be observed on the tracheal smooth muscle. The relaxation of smooth muscle by theophylline is antagonized by adenosine at very low concentrations (56).

Platelet adenylate cyclase stimulated by adenosine is also antagonized by theophylline (71) (Fig. 3).

These findings increase considerably our understanding of the mode of action of caffeine and further delucidate the pharmacological implications of caffeine intake.

Fig. 3

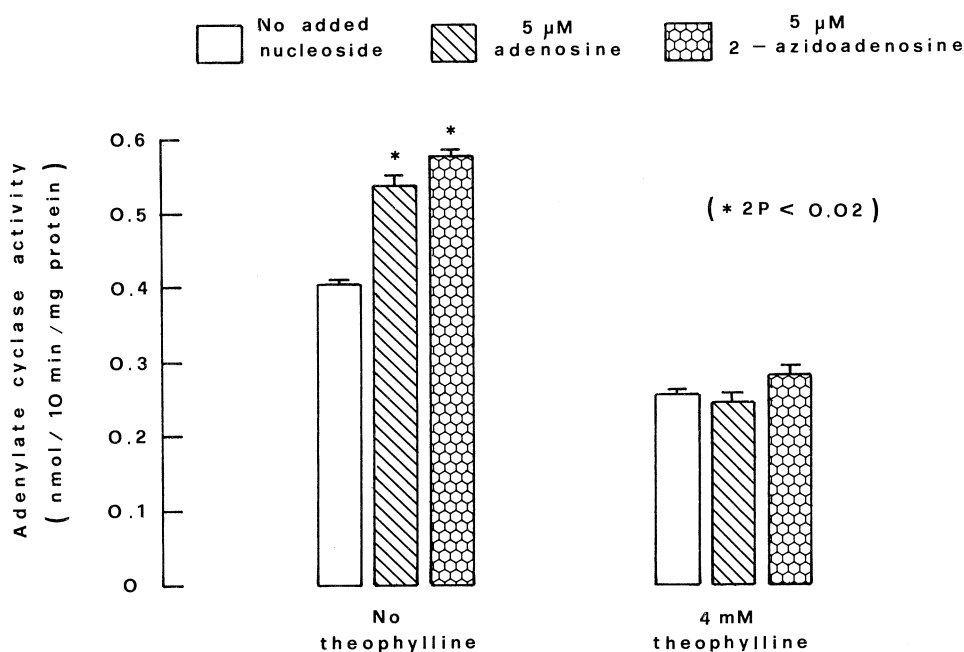

(Abridged from Haslam *et al.* (71) p. 193 with permission of Raven Press, New York)

Once again a stimulating agent present in food and selected by different and unrelated human civilizations shows, at the light of modern investigation, a potent pharmacological effect at the level of modulators in the CNS and peripheral tissues. These findings also have relevance for the understanding of the role of caffeine as a drug. The potentiation of the effects of prostaglandins by adenosine in cerebral cells (72) is an important biochemical basis for the conjunct use of inhibitors of central prostaglandin synthesis with anti-adenosine compounds such as caffeine.

Future investigations shall lead to the discovery or design of more long-lasting and specific adenosine antagonists, devoid for instance of phosphodiesterase inhibiting action.

REFERENCES

1. BENTLEY, Prof. : Pharm. J. 6, 457 (1865).
2. ANONYMOUS : Consumers Report, 44, 569-572 (1979).
3. GREDEEN J.F. : The Sciences 19, 6-11 (1979).
4. Coffee: the world cup : International Coffee Organization, London (U.K.) (1979).
5. GRAHAM D.M. : Nutr. Rev. 36, 97-102 (1978).
6. BUNKER M.L. and McWILLIAMS M. : J. Am. Diet. Ass. 74, 28-32 (1979).
7. KRANTZ J.C., Jr and CARR C.J. In : "The Pharmacological Principles of Medical Practice" 6th Ed., Williams & Wilkins Co., Baltimore, Maryland, pp. 471-474 (1965).

8. RITCHIE J.M. In : "The Pharmacological Basis of Therapeutics", L.S. Goodman and A. Gilman (eds.), MacMillan, New York, pp. 367-378 (1975).
9. STEPHENSON P.E. : J. Am. Diet. Ass. 71, 240-247 (1977).
10. SELECT COMMITTEE ON GRAS SUBSTANCES : SCOGS-89, Life Sciences Research Office, FASEB, Bethesda, Maryland (1976).
11. ELKINS R. and RAPOPORT J. In : International Life Sciences Institute, Second International Caffeine Workshop - Summary of Proceedings, Oct. 22-24 (1979).
12. ROUTH J.I., SHANE N.A., ARREDONDO E.G. and PAUL W.D. : Clin. Chem. 15, 661-668 (1969)
13. SANT'AMBROGIO G., MOGNONI P. and VENTRELLA L. : Arch. Int. Pharmacodyn. 150, 259-263 (1964).
14. BURG W. : Drug Metab. Rev. 4, 199-228 (1975).
15. AXELROD J. and REICHENTHAL J. : J. Pharmacol. Exp. Ther. 107, 519-523 (1952).
16. LATINI R. , BONATI M. CASTELLI D. and GARATTINI S. : Toxicol. Lett. 2, 267-270 (1978).
17. ARNAUD M.J. and THELIN A. : 3rd Int. Symp. on "Quantitative Mass Spectrometry in Life Sciences", Rijksuniversiteit Gent, Belgium, June 10-13 (1980).
18. MAICKEL R.P. and SNODGRASS W.R. : Toxicol. Appl. Pharmacol. 26, 218-230 (1973).
19. GOLDSTEIN A. and WARREN R. : Biochem. Pharmacol. 11, 166-168 (1962).
20. GALLI C., SPANO P.F. and SZYZICEK V. : Pharmacol. Res. Comm. 7, 217-221 (1975).
21. ARNAUD M.J. and BRACCO I. : World Conference on "Clinical Pharmacology and Therapeutics", London, Aug. 3-9 (1980).
22. ALDRIDGE A., ARANDA V. and NEIMS A.H. : Clin. Pharm. Ther. 25, 447-453 (1979).
23. NEIMS A.H. : Nutr. Rev. 37, 124-126 (1979).
24. GUNN T., METRAKOS K., WILLIS D. and ARANDA J.V. : J. Pediatr. 94, 106-109 (1978).
25. THAYER P.S. and PALM P.E. : Crit. Rev. Toxicol. 3, 345-369 (1975).
26. KIHLMAN B.A. "Caffeine and Chromosomes", Elsevier Scientific Publishing Company, Amsterdam, p. 412 (1977).
27. THAYER P.S. and KENSLER C.J. : Toxicol. Appl. Pharmacol. 25, 157-168 (1973).
28. LITTON BIONETICS, Inc. : Summary of mutagenicity screening studies compound FDA 71-44, caffeine. Prepared for Food and Drug Administration under contract no. FDA 71-268, Kensington, Maryland, 91 pp. (1974).

29. BRUCE W.R. and HEDDLE J.A. : Can. J. Genet. Cytol. 21, 319-334 (1979).
30. BAUER A.R., Jr., RANK R.K., KERR R., STRALEY R.L. and MASON J.D. : Life Sci. 21, 63-70 (1977).
31. WURZNER H.P., LINDSTROM E., VUATAZ L. and LUGINBUHL H. : Food Cosmet. Toxicol. 15, 289-296 (1977).
32. BURG A.W. : Testimony presented before the Selected Committee on GRAS Substances at a public hearing on caffeine, Sept. 26, Bethesda, Maryland, Arthur D. Little, Inc.
33. TAKAYAMA S. : Nutr. Rev. 37, 124-126 (1979).
34. TAKAYAMA S. In : International Life Sciences Institute, Second International Caffeine Workshop - Summary of Proceedings, Oct. 22-24 (1979).
35. MOHR U. In : International Life Sciences Institute, Second International Caffeine Workshop - Summary of Proceedings, Oct. 22-24 (1979).
36. ZAYDELA F. and LATARJET R. : C.R. Hebd. Séan. Acad. Sci. Ser. D. 277, 1073-1076 (1973)
37. NOMURA T. : Nature 260, 547-549 (1976).
38. ROTHWELL K. : Nature 252, 69-70 (1974).
39. COLE P. : Lancet 1, 1335-1337 (1971).
40. SIMON D., YEN S. and COLE P. : J. Natl. Cancer Inst. 54, 587-591 (1975).
41. METTLIN C. and GRAHAM S. : Amer. J. Epidem. 110, 255-263 (1979).
42. ARMSTRONG B., GARROD A. and DOLL R. : Brit. J. Cancer 33, 127-136 (1976).
43. CHALLIS B.C. and BARTLETT C.D. : Nature 254, 532-533 (1975).
44. HORNING M.G., BUTLER C.M., NOWLIN J. and HILL R.M. : Life Sci. 16, 651-671 (1975).
45. SIEBER S.M. and FABRO S. : J. Pharmacol. Exp. Ther. 76, 65-75 (1971).
46. COLLINS T.F.X. : FDA By-Lines No. 7, 352-373 (1979).
47. BERTRAND M., GIROD J. and RIGAUD M.F. : C.R. Soc. Biol. 164, 1488-1489 (1970).
48. SULLIVAN F., ELMAZER M. and McELHATTON P. In : International Life Sciences Institute, Second Caffeine Workshop - Summary of Proceedings, Oct. 22-24 (1979).
49. SOBOTKA C.J., SPAID S.L. and BRODIE R.E. : Neurotoxicol. 1, 403-416 (1979).
50. NELSON M.M and FORFAR J.O. : Br. Med. J. 1, 523-527 (1971).
51. HEINONEN O.P., SLONE D. and SHAPIRO S. In : "Birth Defects and Drugs in Pregnancy", Publishing Sciences Group, Inc., Littleton, Mass., pp. 366-370 (1977).

52. WEATHERSBEE P.S., OLSEN L.K. and LODGE J.R. : Postgrad. med. 62, 64-69 (1977).
53. WEATHERSBEE P.S. and LODGE J.R. : Postgrad. Med. 66, 165-171 (1979).
54. WEATHERSBEE P.S. and LODGE J.R. : J. Reprod. Med. 19, 55-63 (1977).
55. GILBERT E.F. and PISTEY W.R. : J. Reprod. Fertil. 34, 495-499 (1973).
56. BUTCHER R.W. and SUTHERLAND E.W. : J. Biol. Chem. 237, 1244-1250 (1962).
57. PUGLISI L., MAGGI F. and PAOLETTI R. In : "Proceedings ASIC 8th International Scientific Colloquium on Coffee", Abidjan, Nov. 28-Dec. 3, 1977.
58. FREDHOLM B.B. : Trends Pharm. Sci. 1, 129-132 (1980).
59. DALY J. and BRUNS R.J. In : International Life Sciences Institute, Second International Caffeine Workshop - Summary of Proceedings, Oct. 22-24 (1979).
60. SNYDER S. In : International Life Sciences Institute, Second International Caffeine Workshop - Summary of Proceedings, Oct. 22-24 (1979).
61. DALY J. : "Cyclic Nucleotides in the Central Nervous System" Plenum Press, New York (1977).
62. PREMONT J., PEREZ M. and BOCKAERT J. : Mol. Pharm. 13, 662-670 (1977).
63. PHILLIS J.W., KOSTOPOULOS G.K., EDSTROM J.P. and ELLIS S.W. In : "Physiological and Regulatory Functions of Adenosine and Adenine Nucleotides", H.P. Baer and G. I. Drummond (eds.), Raven Press, New York pp. 343-359 (1979).
64. FREDHOLM B.B. : Med. Biol. 56, 248-286 (1978).
65. SCHWABE U., EBERT R. and ERBLER H.C. : Adv. Cycl. Nucl. Res. 5, 569-584 (1975).
66. FREDHOLM B.B. and HEDQVIST P. In : "Presynaptic receptors", S.Z. Langer, K. Starke and M. Dubocowitch (eds.), Pergamon Press, Oxford (1979).
67. OSSWALD H. : Naunyn Schmiedeberg's Arch. Pharmacol. 288, 79-86 (1975).
68. TAGAWA H. and VANDER A.J. : Circulat. Res. 26, 327-338 (1970).
69. OSSWALD H., SCHMITZ H.J. and KEMPER R. : Pfluegers Arch. 371, 45-49 (1977).
70. SCHRADER J., BAUMANN G. and GERLACH E. : Pfluegers Arch. 372, 29-35 (1977).
71. HASLAM R.J., DAVIDSON M.M.L., LEMMEX B.W.G., DESJARDINS J.V. and McCARRY B.E. In : "Physiological and Regulatory Functions of Adenosine and Adenine Nucleotides" H.P. Baer and G.I. Drummond (eds.), Raven Press, New York, pp. 189-204 (1979).
72. BERTI F., TRABUCCHI M. BERNAREGGI V. and FUMAGALLI R. : Adv. Biosciences 9, 475-480 (1973).

BILDUNG VON AROMASTOFFEN DURCH MAILLARDREAKTION

R. TRESSL

Forschungsinstitut für Chemisch-technische Analyse,

Technische Universität Berlin,

Seestrasse 13, D-1000 Berlin 65

1. EINLEITUNG

Umsetzungen von Proteinstoffen mit Kohlenhydraten wurden erstmals von Maillard (1) im Jahr 1912 systematisch untersucht. Nach ihrem ersten Bearbeiter bezeichnet man Reaktionen von Aminokomponenten mit reduzierenden Zuckern als Maillardreaktionen. Bei der Hitzebehandlung von Lebensmitteln führen Reaktionen von Zuckern und Aminosäuren zu braungefärbten hochmolekularen Produkten, die als Melanoidine bezeichnet werden. Hierbei wurden freie Aminosäuren sowie proteingebundenes Lysin, das eine freie α -Aminogruppe besitzt, zerstört, was eine Verminderung des Eiweissstoffwertes zur Folge hat (2). Ueber viele Jahre wurde die Maillardreaktion unter diesem Aspekt bearbeitet (3). Bis heute weiss man noch wenig über die Struktur dieser Melanoidine. Neuere Arbeiten von japanischen Arbeitskreisen (4, 5) lassen darauf schliessen, dass Stickstoffheterocyclen wie Pyrazine, Pyridine und Imidazole über Furane und andere Zuckerabbauprodukte verknüpft sind.

Neben hochmolekularen Stoffen werden bei Maillardreaktionen auch flüchtige, bevorzugt heterocyclische Komponenten freigesetzt, die als Aromastoffe eine zentrale Rolle haben. Nachdem die methodischen Voraussetzungen zur Trennung und Strukturaufklärung von Komponenten im Spurenbereich gegeben waren, wurden in den vergangenen Jahren Maillardreaktionen bevorzugt unter dem Aspekt der Aromabildung bearbeitet. Es wurden mehrere hundert Aromakomponenten in Kaffee (6, 7), Kakao (8), Brot (9), gebratenem Fleisch (10, 11), Popkorn (12), Bier (13) und gerösteten Erdnüssen (14) identifiziert, die vorwiegend aus Maillardreaktionen resultieren.

Abb. 1 zeigt die Entwicklung der Aromaforschung anhand einiger ausgewählter Beispiele. Man erkennt, dass die Zahl der charakterisierten Komponenten in Lebensmitteln, deren Aroma durch Erhitzen entsteht, sehr steil ansteigt. Doch nicht alle charakterisierten Verbindungen tragen zum Aroma bei. Häufig bestimmen wenige Spurenkomponenten das sensorische Prinzip. In vielen hitzebehandelten Lebensmitteln sind diese Impaktkomponenten noch nicht bekannt. Nach unserer Meinung ist es heute wesentlich, die sensorisch relevanten Komponenten aus dem Komplex herauszukristallisieren und wenigstens semiquantitative Angaben über ihre Konzentrationen im jeweiligen Lebensmittel zu machen. Denn häufig entscheidet nur die Konzentration einer Aromakomponente, ob sie zum Gesamtaroma beiträgt, bedeutungslos ist oder gar ein Fehl aroma verursacht. Doch fehlen bei den meisten Untersuchungen diese Angaben. Dies wird verständlich,

bedenkt man den hohen finanziellen Aufwand, den diese Forschung erfordert. Häufig fehlen wesentliche Ergebnisse in Publikationen, die man später in Form von Patenten erfährt.

In Röstkaffee wurden bisher mehr als 500 Verbindungen charakterisiert. Es ist anzunehmen, dass etwa die gleiche Anzahl noch nicht bekannt ist. Mehr als die Hälfte der identifizierten Kaffeearomastoffe sind heterocyclische Verbindungen. Wie aus Abb. 2 ersichtlich, wurden bisher in Röstkaffee 107 Furane, 27 Thiophene, 65 Pyrrole, 28 Thiazole, 28 Oxazole, 11 Pyridine und 80 Pyrazine identifiziert.

Eine Abgrenzung der Maillardreaktion von anderen Wegen, die beim Rösten ablaufen, ist schwierig. So können Furane und Pyranone auch aus Karamelisierungsreaktionen oder thermischen Fragmentierungen entstehen - Pyrrole und Pyridine aus Trigonellin. Leider gibt es bisher kaum Arbeiten, die sich mit der Veränderung von freien Aminosäuren des Rohkaffees und seiner Verarbeitung beschäftigen. Amadorikomponenten sind in Rohkaffee bisher nicht charakterisiert worden.

Ich möchte versuchen, anhand von eigenen Beobachtungen sowie den Ergebnissen verschiedener Arbeitskreise die Bedeutung der Maillardreaktionen für die Aromabildung zu erläutern. Die eigenen Ergebnisse beziehen sich auf Untersuchungen von hellem und dunklem Malz, Karamelmalz, Röstkaffee sowie von Modellsystemen.

2.1 BILDUNG VON FURANVERBINDUNGEN (Thiophenen, Pyrrolen)

Die meisten heterocyclischen Komponenten in dunklem Malz und Röstkaffee etc. resultieren aus Maillardreaktionen. Im ersten Schritt der Reaktion reagieren Aminokomponente und Aldose unter Bildung eines N-Glycosides, das eine Amadori-Umlagerung erleidet, wobei das Derivat der entsprechenden Ketose entsteht (3). Glucose und Alanin ergeben Fructose-Alanin, eine Amadorikomponente, die in Malz, Trockenfrüchten, Melasse und Leberextrakten nachgewiesen wurde. Auch Fructose reagiert mit Aminosäuren über ein labiles N-Glycosid, das eine Heyns-Umlagerung erleidet und in eine 2-Desoxy-2-amino-aldose überführt wird (Abb. 3). Diese Umlagerungsprodukte wurden in vielen Lebensmitteln charakterisiert (15, 16).

Wie aus Abb. 4 ersichtlich, werden Amadorikomponenten beim Erhitzen über 1,2 Enaminole in 3-Desoxyosone (pH 3 - 5) bzw. über 2,3-Endiole (pH 5 - 7) in 1-Desoxyosone umgewandelt, die weiter in Aromastoffe überführt werden. Die entsprechenden Glucoseaminosäuren (Heyns-RP) erleiden 1,2-Enolisierung (3-Desoxyosone). Amadorikomponenten sind hitzelabil und zerfallen beim Erwärmen unter Dehydratisierungs- und Spaltungsreaktionen, wie entsprechende Untersuchungen von Mills et al. (17) sowie von Mills und Hodge (18) ergaben. Sie stellen somit die nichtflüchtigen Precursoren in Lebensmitteln dar. Die Reaktionsbedingungen und der basische Charakter der Aminokomponente bestimmen das Spektrum der gebildeten Aromastoffe.

Abb. 5 zeigt ein stark vereinfachtes Reaktionsschema, das die Bildung von Furanen und Furaneol (4-Hydroxy-2,5-dimethyl-3(2H)-furanon) aus Glucose erklärt. 5-Hydroxymethylfurfural und 5-Methylfurfural entstehen über 3-Desoxyhexoson durch Dehydratisierung. Aus einem zweiten Reaktionszweig werden 2-Acetylfuran und Furaneol über 1-Desoxyhexoson gebildet. Pentosen werden entsprechend in Furfuraldehyd und 4-Hydroxy-5-methyl-3-(2H)-furanon überführt. Während dieser Reaktionen kann der Sauerstoff des Furanringes durch Schwefel bzw. Stickstoff ausgetauscht werden. Dabei entstehen die entsprechenden Thiophene und Pyrrole, die neben Furanen in den meisten hitzebehandelten Lebensmitteln vorkommen. Aus 1-Desoxyhexoson entstehen durch Spaltung der Kohlenstoffkette α -Dicarbonylkomponenten wie Diacetyl, Pyruvaldehyd, Acetol etc., die in Form des Streckerabbaus mit Aminosäuren weiterreagieren. Im Röstkaffee sind bis heute mehr als 107 Furane, 28 Thiophene und 65 Pyrrole bekannt, die aus dieser Reaktion resultieren. Ueber den sensorischen Beitrag dieser Komponenten zum Kaffeearoma gibt es wenig Angaben. Die wichtigste Komponente aus dieser Stoffklasse scheint Furfurylmercaptan zu sein, das schon 1925 von Reichstein und Staudinger (19) identifiziert wurde. Nach eigenen Untersuchungen besitzt Furfurylmercaptan, das vermutlich aus Furfuraldehyd und Cystein entsteht, im extremen Spurenbereich den Aromacharakter von frisch aufgebühtem Kaffee und wird bei höheren Konzentrationen mercaptanartig empfunden (20).

2.2 BILDUNG VON KAMELKOMponentEN

Disaccharide wie Maltose und Lactose bilden 5-Hydroxy-5,6-dihydromaltol, 5-Hydroxymaltol und Maltol, wie in Abb. 6 ersichtlich. Alle Komponenten konnten wir in Malz, Würze, Bier und Röstkaffee identifizieren. Maltol (III) wurde erstmals von Brand (21) in Malz, 5-Hydroxy-5,6-dihydromaltol (I) von Mills et al. (22) in Zucker-Amin-Modellumsetzungen und 5-Hydroxymaltol (II) von Shimizu et al. (23) in gerösteter Gerste charakterisiert. Wie Cycloten, Isomaltol und Furaneol besitzen sie Karamelaroma. Ihr Aromacharakter ändert sich mit steigender Konzentration und wird dann wie verbrannter Zucker empfunden. Die interessanteste Verbindung ist Furaneol mit einem Schwellenwert von 30 ppb (24). Einige dieser Komponenten wirken als Geschmacksverstärker und besitzen antioxidantische Eigenschaften.

Mills und Hodge (18) zersetzten 1-Desoxy-1-L-prolin-D-fructose (Amadorikomponente aus Prolin und Glucose) im Vakuum bei 140°C und bei 240°C. Sie kondensierten die Destillate und identifizierten mit Hilfe von Gaschromatographie, Massenspektrometrie und Kernresonanzspektroskopie 22 Komponenten. Bei 140°C entstanden vorwiegend Dehydratisierungsprodukte mit sechs C-Atomen, wie aus Abb. 7 ersichtlich. Bei 240°C traten mehrere Pyrrolin- und Pyrrolidinderivate auf, während nur Spuren von Maltol entstanden. Bei niedrigeren Zersetzungstemperaturen zerfällt die Amadorikomponente in 5-Hydroxy-5,6-dihydromaltol (IV, 50 %), 2,5-Dimethyl-2,4-dihydroxy-3 (2H)-furanon (III, 5,8 %), 4-Hydroxy-2,5-dimethyl-3 (2H)-furanon (II, 2 %), Cycloten (I, 1,2 %) und Hydroxymaltol (IV, 1,0 %). Diese Ergebnisse sind vergleichbar mit eigenen Untersuchungen von Karamelkomponenten in Malz und Röstkaffee (25, 26). 5-Hydroxy-5,6-dihydromaltol ist die Hauptkomponente in hellem und dunklem Malz, während im Röstkaffee Maltol als Hauptkomponente auftritt.

In Abb. 8 sind einige Karamelkomponenten enthalten, die wir vor kurzem in Röstkaffee charakterisierten. Man erkennt, dass sich die unter gleichen Bedingungen gerösteten Kaffeesorten deutlich unterscheiden. Arabica-Kaffee weist höhere Konzentrationen an Furaneol und Cycloten auf, während Robusta-Kaffee die grössten Gehalte an Maltol zeigt. Höhere Röstbedingungen bewirkten keine Zunahme der Karamelkomponenten, doch werden Furaneol und 5-Hydroxy-5,6-dihydromaltol offensichtlich zersetzt. Die in Abb. 8 enthaltenen Karamelkomponenten liegen in relativ hohen Konzentrationen in Röstkaffee vor und tragen zu Aroma und Geschmack bei. Aufgrund ihres hydrophilen Verhaltens gelangen sie in Filterkaffee und werden in Kaffee-Extrakten angereichert. Man erkennt, dass insbesondere die Gehalte an HMF, Cycloten und Maltol im Extraktkaffee stark zunehmen und die Geschmacksdifferenzen mit erklären können.

Drei neue Karamelkomponenten wurden kürzlich in Melasse und Sojasauce identifiziert. Zwei isomere Aethylfuraneole sind in Shoyu im Verhältnis 3:2 enthalten (27). Nach Re et al. (24) besitzen beide Komponenten den Flavor von gekochten Früchten. Ito (28) identifizierte ein Pyranon in Melasse. Während der Isolierung von 5-Hydroxy-5,6-dihydromaltol beobachteten wir eine Umwandlung dieser geruchlosen Komponente in intensiv riechende Karamelkomponenten. Mills und Hodge (18) fanden eine Umwandlung von 5-Hydroxy-5,6-dihydromaltol in die übrigen Karamelkomponenten beim Erhitzen mit Prolin. Offensichtlich ist das geruchlose Zwischenprodukt ein Precursor für die übrigen Karamelkomponenten. In Gegenwart von Cystein oder Schwefelwasserstoff kann der Sauerstoff dieser Heterocyclen durch Schwefel ersetzt werden. Dabei ändern sich ihre Geruchsqualitäten. Abb. 9 zeigt Furanone, Pyranone, 2-Hydroxy-2-butenolide sowie Cyclopenten(hexen)-one, die in Kaffee enthalten sind. Man erkennt, dass alle Komponenten eine Keto-, enolische Hydroxyl- und Methylgruppe in planarer Anordnung besitzen. Dieses Strukturelement ist für den Karamelflavor verantwortlich.

3.1 BILDUNG VON AROMAKOMponentEN AUS STRECKERALDEHYDEN

Mit α -Dicarbonylverbindungen wie Glyoxal, Methylglyoxal, Diacetyl usw. erleiden Aminosäuren beim Erwärmen den Strecker'schen Abbau (3). Dabei werden die Aminosäuren in die um ein C-Atom ärmeren Carbonylverbindungen überführt, die zum Teil typische Aromaten aufweisen, wie erstmals Untersuchungen von Herz und Schallenberger (29) ergaben. In Abb. 10 sind einige Streckeraldehyde und Folgeprodukte, die wir als wesentliche Aromakomponenten von Malz charakterisierten, zusammengefasst. Insbesondere die Streckeraldehyde von Val (I), Leu (II) und Ile (III) werden malzartig empfunden. Das Abbauprodukt von Met, Methional (IV), ist das geruchsbestimmende Prinzip der gekochten Kartoffel und ausserdem als Spurenkomponente für den

"Lichtgeschmack" von Milchprodukten verantwortlich. Phenylacetaldehyd (VI) ergibt unter den diskutierten Reaktionsbedingungen mit den übrigen Aldehyden Aldolkondensationen zu 2-Phenylalkenalen, die in Malz und Kakao identifiziert worden sind. Einige dieser Komponenten (VII-X) besitzen Kakaogeruch. Von den Streckeraldehyden liegt nur 2-Phenyläthanal in grösseren Konzentrationen in Röstkaffee vor. Wie aus Abb. 11 ersichtlich, können bei der Extrakterstellung daraus weitere Komponenten entstehen. 2-Phenyläthanal kondensiert mit Acetaldehyd zu 2-Phenyl-2-butenal und bildet mit Glyoxal unter Röstbedingungen 3-Phenylfuran.

In Gegenwart von 2-Oxosäuren unterliegen Streckeraldehyde Aldolkondensationen zu 2-Hydroxy-2-butenoliden, die Karamel- bzw. "würzig-maggiartigen" Flavor besitzen. Aus 2-Oxobuttersäure entsteht mit Propanal 3-Hydroxy-5-äthyl-4-methyl-2 (5H)-furanon in Proteinhydrolysaten (30) sowie mit Acetaldehyd 3-Hydroxy-4,5-dimethyl-2 (5H)-furanon als wesentliche Komponente in Saké (31). Beide Verbindungen haben intensiv würzig-maggiartigen Aromacharakter und besitzen Schwellenwerte von 70 - 80 ppb. Nach unseren Untersuchungen sind sie in vielen Lebensmitteln, bei denen der Hitzebehandlung eine Fermentation vorgeschaltet wird, enthalten. Neben 2-Oxobuttersäure dient auch 2-Oxoisocaproinsäure, das Transaminierungsprodukt von Leucin, als Precursor für 2-Hydroxybutenolide. In Modellversuchen konnten wir zeigen, dass auch *Saccharomyces cerevisiae* diese Oxosäuren bzw. die entsprechenden Aminosäuren in Hydroxybutenolide überführt (32).

3.2 BILDUNG VON STICKSTOFFHETEROCYCLEN AUS PROLIN UND HYDROXYPROLIN

Unter den Proteinaminosäuren besitzen nur Prolin und Hydroxyprolin sekundäre Aminogruppen. Sie ergeben keinen (normalen) Streckerabbau und sind als Precursor für Nitrosamine bekannt (33, 34). In Abb. 12 sind einige Produkte, die beim Erhitzen von 1-Desoxy-1-L-prolino-D-fructose bei 140°C und 240°C charakterisiert worden sind, zusammengefasst (18). Shigematsu et al. (35) untersuchten die Umsetzungsprodukte von Prolin und Glucose, die bei fünfminütigem Erhitzen bei 200°C entstehen. Neben Karamelkomponenten identifizierten sie 5-Acetyl- und 5-Formyl-2,3-dihydro-1H-pyrrolizine, die aminartige süßliche Aromaten besitzen. Aus Abb. 12 erkennt man als Pyrolyseprodukte der Amadorikomponente 1-Pyrrolin (I), 2-(Hydroxymethyl)-pyrrolidin (II), 2-Formylpyrrolidin (III) und das Diketopiperazin (IV), das nach unseren Untersuchungen einen intensiv bitteren Geschmack aufweist und in gerösteter Gerste vorkommt (36). Die N-Acylpyrrolidine sind bisher nur in Tabak (37), die N-Furfurylpyrrolidine unseres Wissens bisher nur in Malz und Bier nachgewiesen worden. Umsetzungsprodukten von Prolin mit reduzierenden Zuckern werden brotartige Aromaten zugeschrieben (38). Bisher sind diese Komponenten noch nicht systematisch untersucht worden. Wir erhitzen äquimolare Mengen von Prolin und Glucose bei 100°C sowie bei 250°C und charakterisierten die Reaktionsprodukte mit Hilfe der Methodik Kapillargaschromatographie-Massenspektrometrie. Unter Kochbedingungen entstehen aus Prolin Pyrrol, Acylpyrrolidine, 2-Acetylpyridin sowie 5-Acetyl- und 5-Formyl-2,3-dihydro-1H-pyrrolizine als konzentrationsstärkste Verbindungen. 2-Acetylpyridin besitzt brotigen Aromacharakter mit einem Schwellenwert von 10 ppb. Die beiden Pyrrolizine haben gebäckartige Noten und werden bei höheren Konzentrationen zimtartig empfunden. Alle Komponenten konnten wir auch in Malz, Bier und Kaffee identifizieren. Unter Röstbedingungen überwiegen alkylsubstituierte Pyrrole und Pyridine, die als Spurenkomponenten in vielen hitzebehandelten Lebensmitteln bekannt sind.

Einige Ergebnisse der entsprechenden Modellumsetzungen von Hydroxyprolin und Glucose sind in Abb. 13 ersichtlich. Es konnten mehr als 50 Heterocyclen charakterisiert werden. Die Ergebnisse und angewandten Methoden werden detailliert publiziert (39). Die Umsetzungsprodukte von Hydroxyprolin besitzen weniger brotartige Aromaten als die entsprechenden Prolinreaktionsprodukte. Als Hauptkomponenten entstehen N-Alkyl-, N-Acyl- und N-Furfurylpyrrole. N-Acetylpyrrol wurde erstmals von Kobayasi und Fujimaki (40) charakterisiert und entsteht auch bei Umsetzungen von Hydroxyprolin mit Pyruvaldehyd. Viele dieser Verbindungen sind als Aromakomponenten in gekochten und gerösteten Lebensmitteln bekannt. Einige der N-Acylpyrrole besitzen brotartige Noten, während die N-Furfurylpyrrole grünen, pilzartigen Aromacharakter aufweisen. Beide Stoffgruppen sind als Hauptkomponenten im Röstkaffee identifiziert worden. In Abb. 13 sind einige Reaktionswege für Hydroxyprolin, die wir in Modellumsetzungen überprüft haben, dargestellt. N-Furfurylpyrrol, N-(5-Methyl-furfuryl)-pyrrol, N-Acetylpyrrol und N-(2-Butanoyl)-pyrrol dürften in Röstkaffee aus dieser Reaktion resultieren.

3.3 BILDUNG VON ALDIMINEN, AMINEN UND PYRROLEN

1974 beobachtete Rizzi (41) die Bildung von N-Alkyl-2-formyl-pyrrolen und aliphatischen Aldiminen bei Umsetzungen von Aminosäuren mit Furfuraldehyd. In Abb. 14 sind die Umsetzungsprodukte von Valin und Furfuraldehyd zusammengefasst. Alle Verbindungen konnten wir erstmals in dunklem und Karamelmalz sowie in dunklen Bieren charakterisieren. Die Komponenten I und II besitzen Kakaogeruch und Isobutanal (V) wird malzartig empfunden. Auch die Aminosäuren Leu, Ile und Ala werden durch diese Reaktion in entsprechende Aromastoffe überführt. Im Röstkaffee wurden zahlreiche N- und C-substituierte Pyrrole nachgewiesen, die Isobutyl, 2-Methylbutyl- und Isoamylreste enthalten. Die säulenchromatographische Trennung eines Röstkaffeearomakonzentrates nach Stoffgruppen führte zu einer Fraktion, die intensives Kaffeearoma hatte und neben schwefelhaltigen Furanderivaten zahlreiche N-Alkyl- und N-Furfuryl-pyrrole enthielt. Abb. 15 zeigt N-Alkylpyrrole, die in Röstkaffee charakterisiert wurden. Man erkennt, dass viele dieser Komponenten aus den Aminosäuren Ala, Val, Ile und Leu - vermutlich über die entsprechenden Amine - entstehen. 1-Methylpyrrol (aus Trigonellin) wurde mit etwa 3000 ppm - N-Isoamyl-2-methylpyrrol mit etwa 50 ppb bestimmt. Sie liegen in Robusta stärker vor als in Arabica und sind aufgrund ihrer Flüchtigkeit in Extraktkaffees kaum enthalten. Abb. 16 zeigt die Reihe von N-Furfurylpyrrolen, die in Arabicasorten stärker gebildet werden. Während die Alkylpyrrole pyridinartige Noten besitzen, werden die Furfurylpyrrole angenehm grün, pilzartig empfunden. Die Komponenten I und II entstehen vermutlich aus Hydroxyprolin und Furfuraldehyd bzw. 5-Methylfurfuraldehyd, die übrigen aus Furfurylamin, 5-Methyl-furfurylamin, 2-Phenyläthylamin und Zuckerabbauprodukten. Einige N-Furfurylpyrrole verändern sich während der Alterung von Röstkaffee. Ueber diese Ergebnisse sowie die angewandten Methoden werden wir detailliert berichten (42).

3.4 BILDUNG VON SCHWEFELHALTIGEN FURANDERIVATEN

Furfuraldehyd spielt für die Genese wesentlicher Kaffeearomastoffe eine zentrale Rolle. Wie aus Abb. 17 ersichtlich, führt der Streckerabbau von Cystein (Cystin) und Methionin mit Furfural zu H_2S und CH_3-SH , die in viele schwefelhaltige Furanderivate eingebaut werden. Dies konnte mit Hilfe von Modellumsetzungen bestätigt werden. Die Zahlen in Abb. 17 geben die prozentuale Verteilung an. Die Verbindungen I bis IV wurden auch als schwefelhaltige Hauptkomponenten des Röstkaffeearomas charakterisiert. Furfurylmethylsulfid (III) besitzt den Aromacharakter von frischem Weissbrot (43), Furfurylmercaptan (I) in grosser Verdünnung von frisch aufgebrühtem Kaffee (Schwellenwert in Wasser etwa 0,005 ppb), in grösserer Konzentration mercaptanartiges Aroma (20). Furfuraldehyd kann ausserdem in Furfurylalkohol und Furancarbonsäure disproportionieren, die unter den extremen Reaktionsbedingungen des Röstens in zahlreiche Furfurylester, Furancarbonsäureester und Furfuryläther überführt werden, die erstmals von Stoll et al. (6) in Kaffeeöl nachgewiesen wurden.

Abb. 18 zeigt einige Komponenten, die bei Modellumsetzungen von Rhamnose mit Cystein und Methionin entstehen. Als Hauptkomponenten konnten - wie zu erwarten - Furaneol (II), 5-Methylfurfuraldehyd und 2,5-Dimethyl-(2H)-3-furanon (I) charakterisiert werden. 5-Methylfurfuraldehyd wird teilweise in 5-Methylfurfurylmercaptan, 5-Methylfurfurylmethylsulfid und 5-Methylfurfuryldisulfid überführt. 2,5-Dimethyl-3-mercaptofuran, 2,5-Dimethyl-3-methylthiofuran (IV), 2,5-Dimethyl-3-methyldithiofuran (V) und 4-Mercapto-2,5-dimethyl-(2H)-3-furanon (VI) konnten als konzentrationschwächere, aber sensorisch wirksame Verbindungen identifiziert werden. Ueber weitere Komponenten, die aus diesen Reaktionen resultieren, werden wir an anderer Stelle detailliert berichten.

In Abb. 19 sind einige schwefelhaltige Furanderivate des Röstkaffeearomas zusammengefasst. Die Aufarbeitung erfolgte etwa 10 Tage nach dem Rösten. Man erkennt, dass Robusta-Kaffee in der Regel grössere Mengen Schwefelkomponenten enthält. Arabicasorten zeichnen sich durch grössere Gehalte an 5-Methylfuranderivaten und Kahweofuran aus. Im untersuchten Extraktkaffee sind insbesondere Derivate des Furfurals stark enthalten. Viele dieser Schwefelkomponenten konnten wir erstmals in Röstkaffee charakterisieren. Mehr als zwanzig Mercaptane, Sulfide, Di- und Trisulfide wurden mit Hilfe von Kapillargaschromatographie und Massenspektrometrie in Aromakonzentraten von gerösteten Arabica- und Robusta-Kaffees charakterisiert und quantifiziert. 15 schwefelhaltige Furanderivate wurden erstmals identifiziert und durch Synthese bestätigt. Ueber diese Ergebnisse und die angewandten Methoden wird an anderer Stelle berichtet (44). Abb. 20

zeigt eine Auswahl dieser Komponenten. Disulfide und Trisulfide sind im frisch gerösteten Kaffee kaum enthalten, sie akkumulieren jedoch in gealtertem Kaffee und in Extraktkaffee.

Abb. 21 zeigt das Verhalten einiger Schwefelverbindungen während der Alterung von Röstkaffee. Man erkennt, dass die Gehalte von Furfurylmercaptan und 5-Methylfurfurylmercaptan stark ansteigen. Nach etwa 10 - 14 Tagen sind die Konzentrationen soweit erhöht, dass man mercaptanige Noten auch sensorisch erfassen kann.

4. BILDUNG VON PYRAZINEN, THIAZOLEN, OXAZOLEN

4.1 Pyrazine,

Die röstartigen Aromacharakter besitzen, sind um so zahlreicher und konzentrationsstärker enthalten, je höher ein Lebensmittel erhitzt wird. Bisher wurden über sechzig Pyrazine in Kaffee (7), Kakao (8), Popkorn (12), gerösteten Erdnüssen (14) und gebratenem Fleisch (11) charakterisiert. Eine umfangreiche Zusammenfassung über Vorkommen, Aromaeigenschaften und Bildung von Pyrazinen publizierten Maga und Sizer (45). In Abb. 22 sind einige Pyrazine mit Geruchsqualitäten und Schwellenwerten zusammengefasst. Man erkennt, dass sowohl die Geruchsqualitäten als auch die Schwellenwerte innerhalb dieser Verbindungsklasse enorm variieren. Neben Alkylpyrazinen wurden in Röstkaffee auch Acyl-, Furyl-, 5,6-Dihydrocyclopentapyrazine und Cyclopentapyrazine bestimmt. Nach Flament et al. (46) ist Cycloten ein Precursor für die Bildung sensorisch relevanter Cyclopentapyrazine, wie aus Abb. 23 ersichtlich. Man erkennt, dass α -Diketokomponenten, die aus dem Zucker resultieren, während des Strecker'schen Abbaus in die entsprechenden Amino-ketone überführt werden, die zu alkylsubstituierten Pyrazinen unter Dehydratisierung und Dehydrierung reagieren. Cycloten und seine Derivate können in Dihydrocyclopentapyrazine und Cyclopentapyrazine überführt werden. Furylpyrazine entstehen vermutlich aus Furyldionverbindungen, die im Röstkaffee bekannt sind. Die von Vitzthum und Werkhoff (47) im Rohkaffee charakterisierten Alkoxy-pyrazine entstehen vermutlich aus den entsprechenden Aminosäurenamiden. Im Röstkaffee wurden auch Methylthiopyrazine charakterisiert. Alkylsubstituierte Pyrazine sind in Konzentrationen bis zu 40 ppm (2,5- und 2,6-Dimethylpyrazine), Dihydrocyclopentapyrazine etwa im ppm-Bereich, Alkoxy-pyrazine im ppb-Bereich im Röstkaffee enthalten.

4.2 Thiazole, Oxazole

In Gegenwart von Cystein oder H_2O resultieren aus dem Streckerabbau Thiazole, die ebenfalls in vielen erhitzten Lebensmitteln bekannt sind (Abb. 24). Mehr als 20 Thiazole und Oxazole wurden erstmals von Vitzthum und Werkhoff (48) in Röstkaffeearoma identifiziert. Thiazole besitzen grüne, gemüseartige bzw. brotartige Aromen und sehr niedrige Schwellenwerte. Sie kommen wie die strukturverwandten Oxazole im ppb-Bereich vor. Wie aus Abb. 24 ersichtlich, gibt es mehrere Wege, auf denen Thiazole entstehen können. Nach Vitzthum und Werkhoff (48) sowie nach Baltes (49) führt der Streckerabbau von Cystein mit α -Diketoverbindungen zu Alkyl- bzw. Acylthiazolen während das Decarboxylierungsprodukt des Cysteins mit Aldehyden zu 2-Alkylthiazolen umgesetzt wird. Diese Reaktionswege konnten von Shibamoto (50) durch Modellversuche bestätigt werden. In analogen Reaktionen werden die Aminosäuren Threonin und Serin in Oxazole überführt.

Zusammenfassend zeigen diese Ausführungen die Vielfalt der Reaktionswege, aus denen Röstkaffeearomastoffe resultieren. Bisher fehlen eingehende Untersuchungen der Precursors in Rohkaffee, die in Form der Maillardreaktion während der Lagerung und des Röstens zu Aromastoffen führen. Bezüglich dieser Precursors dürften sich Kaffeesorten wie Arabica und Robusta signifikant unterscheiden.

Während beim Darren des Malzes im wesentlichen die Aminosäuren Val, Leu, Ile, Phe und Met, Cys sowie Pro mit Maltose und Glucose zu Aromastoffen führen, sind die Reaktionswege durch die drastischeren Röstbedingungen in Kaffee viel komplexer. Es fällt jedoch auf, dass wesentliche Kaffeearomastoffe aus reaktiven Abbauprodukten von Zuckern (Furfuraldehyd, 5-Methylfurfuraldehyd, Cycloten, Furaneol, 2,3-Pentandion) und Aminosäuren (H_2S , CH_3-SH) entstehen.

LITERATUR

1. MAILLARD, L.C., C.R. Acad. Sci. 154, 66 (1912)
2. ADRIAN, J., Industr. Alim. Agric. 1281 (1972)
3. HODGE, J.E., J. Agr. Food Chem. 1, 928 (1953)
4. TSUCHIDA, H., KOMOTO, M., KATO, H., FUJIMAKI, M., Agr. Biol. Chem. 39, 1143 (1975)
5. TSUCHIDA, H., KOMOTO, M., KATO, H., JURATA, T., FUJIMAKI, M., Agr. Biol. Chem. 40, 2051 (1976)
6. STOLL, M., WINTER, M., GAUTSCHI, F., FLAMENT, J., WILLHALM, B., Helv. Chim. Acta 50, 628 (1967)
7. MARION, J.P., MÜGGLER-CHAVAN, F., VIANI, R., BRICOUT, J., REYMOND, D., EGLI, R.H., Helv. Chim. Acta 50, 1509 (1967)
8. Van PRAAG, M., STEIN, H.S., TIBBETTS, M.S., J. Agr. Food Chem. 16, 1005 (1968)
9. MULDER, E.J., ten NOEVER de BRAUW, M.C., van STRATEN, S., Z. Lebensm.-Unters. u. - Forsch. 150, 306 (1973)
10. WASSERMAN, A.E., J. Agr. Food Chem. 20, 737 (1972)
11. HIRAI, C., HERZ, K.O., POKORNY, J., CHANG, S.S., J. Food Sci. 38, 393 (1973)
12. WALRADT, J.P., LINDSAY, R.C., LIBBEY, L.M., J. Agr. Food Chem. 18, 926 (1970)
13. TRESSL, R., RENNER, R., KOSSA, T., KOEPLER, H., EBC-Proc. 16th Congr. Amsterdam 1977, S. 693.
14. WALRADT, J.P., PITTET, A.O., KINLIN, T.E., MURALIDHARA, R., SANDERSON, A., J. Agr. Food Chem. 19, 972 (1971)
15. MILLS, F.D., BAKER, B.G., HODGE, J.E., J. Agr. Food Chem. 17, 723 (1967)
16. Van den OUWELAND, G.A.M., PEER, H.G., TJAN, S.B., Flavor of Foods and Beverages, Acad. Press New York, San Francisco, London 1978, S. 131.
17. MILLS, F.D., BAKER, B.G., HODGE, J.E., Carbohydr. Res. 15, 205 (1970)
18. MILLS, F.D., HODGE, J.E., Carbohydr. Res. 51, 9 (1976)
19. REICHSTEIN, T., STAUDINGER, H., DR. Pat. 489 613 (1925)
20. TRESSL, R., GRUENEWALD, K.G., KAMPERSCHROER, H., SILWAR, R., Prog. Fd. Nutr. Sci. Vol. 4, 111.1 (1980)
21. BRAND, J., Ber. d. Dtsch. Chem. Ges. 27, 806 (1894)
22. MILLS, F.D., WEISLEDER, D., HODGE, J.E., Tetrahedron Letters 15, 1243 (1970)
23. SHIMIZU, V., MATSUTO, S., MIZUNUMA, Y., OKADA, I., Agr. Biol. Chem. 34, 845 (1970)
24. RE, L., MAURER, B., OHLOFF, G., Helv. Chim. Acta 56, 1882 (1973)
25. TRESSL, R., KOSSA, T., RENNER, R., EBC-Proc. 15th Congr. Nice 1975, S. 737.
26. TRESSL, R., BAHRI, D., JENSEN, A., KOEPLER, H., Z. Lebensm.-Unters.-Forsch. 167, 111 (1978)
27. NUNOMURA, N., SASAKI, M., ASAO, Y., YOKOTSUKA, T., Agr. Biol. Chem. 40, 491 (1976)
28. ITO, H., Agr. Biol. Chem. 40, 827 (1976)
29. HERZ, W.J., SCHALLENBERGER, R.S., Food Res. 25, 491 (1960)
30. SULSER, H., HABEGGER, M., BUECHI, W., Z. Lebensm.-Unters.-Forsch. 148, 215 (1972)
31. TAKAHASHI, K., TADEHUMA, M., SATO, S., Agr. Biol. Chem. 40, 325 (1976)

32. TRESSL, R., APETZ, M., ARRIETA, R., GRUENEWALD, K.G., Flavor of Foods and Beverages, Acad. Press New York, San Francisco, London 1978, S. 145.
33. HUXEL, E.T., SCANLAN, R.A., LIBEY, L.M., J. Agr. Food Chem. 22, 699 (1974)
34. SEN, N.P., MILES, W.F., SEAMAN, S., LAWRENCE, J.F., J. Chromatogr. 128, 169 (1976)
35. SHIGEMATSU, H., SHIBATA, S., JURATA, T., KATO, H., FUJIMAKI, M., J. Agr. Food Chem. 23, 233 (1975)
36. SAKAMURA, S., FURUKAWA, K., KUSAI, T., Agr. Biol. Chem. 42, 607 (1978)
37. LLOYD, R.A., MILLES, C.W., ROBERTS, D.L., GILES, J.A., Tobacco Science 20, 40 (1976)
38. HODGE, J.E., MILLS, F.D., FISHER, B.E., Cereal Science Today 17, 34 (1972)
39. TRESSL, R., GRUENEWALD, K.G., in Vorbereitung.
40. KOBAYASI, N., FUJIMAKI, M., Agr. Biol. Chem. 29, 1059 (1965)
41. RIZZI, G.P., J. Agr. Food Chem. 22, 279 (1974)
42. TRESSL, R., GRUENEWALD, K.G., SILWAR, R., Chem. Mikrobiol. Technol. Lebensm., in Druck.
43. MULDER, E.J., KLEIPOOL, R.J.C., ten NOEVER de BRAUW, M.C., Chemistry and Industry 613 (1976)
44. TRESSL, R., J. Agr. Food Chem., in Vorbereitung.
45. MAGA, J.A., SIZER, C.E., J. Agr. Food Chem. 21, 22 (1973)
46. FLAMENT, J., KOHLER, M., ASHIRO, R., Helv. Chem. Acta 59, 2308 (1976)
47. VITZTHUM, O.G., WERKHOFF, P., ABLANQUE, E., 7. Intern. Kolloquium über Kaffee-Chemie (Hamburg 9.-14.6.1975), ASIC Paris, S. 115.
48. VITZTHUM, O.G., WERKHOFF, P., J. Food Sci. 39, 1210 (1974)
49. BALTES, W., 7. Intern. Kolloquium über Kaffee-Chemie (Hamburg 9.-14.6.1975), ASIC Paris, S.91.
50. SHIBAMOTO, T., SAHAGUCHI, M., J. Agr. Food Chem. 26, 1179 (1978)



Abb. 1 Entwicklung der Aromaforschung :
Identifizierte Aromakomponenten von Kaffee, Fleisch,
Bier, Tomate, Banane.



Abb. 2 Heterocyclische Verbindungen in Röstkaffee.

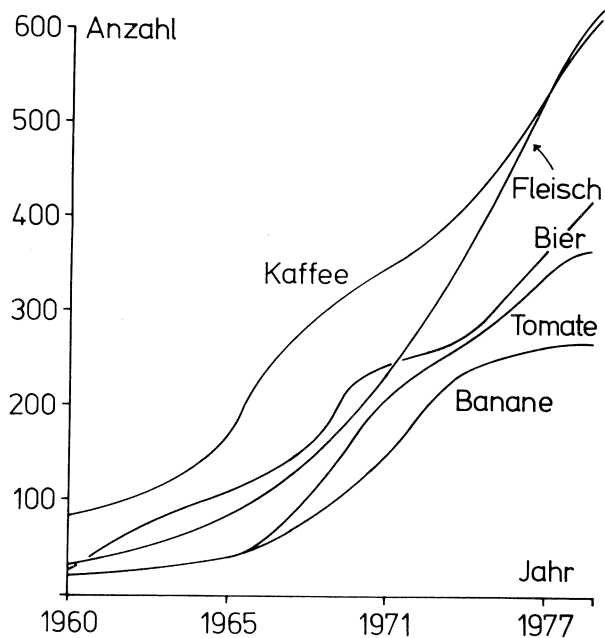

Abb. 3 Bildung von Amadorikomponenten (ARP) und Heyns-Umlagerungsprodukten (HRP) nach van Oweland et al. (1978).

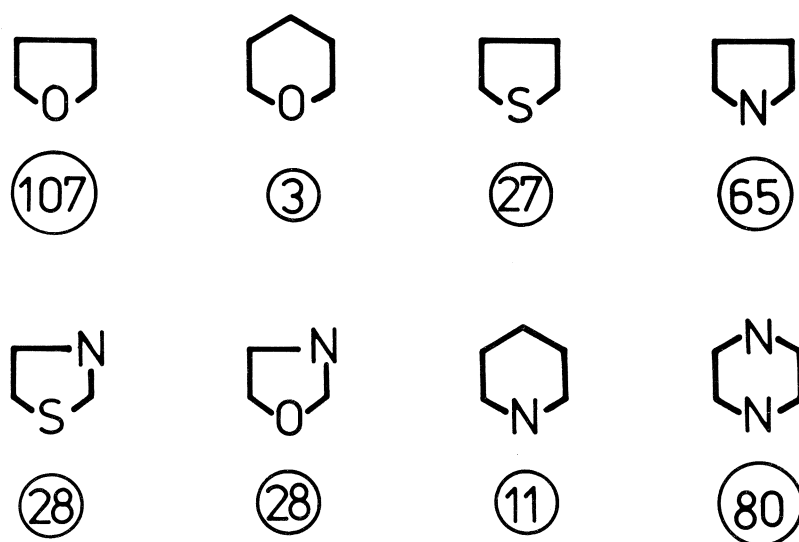

Abb. 4 Umwandlung von ARP's und HRO's nach van den Ouweland (1978) und Hodge (1967).

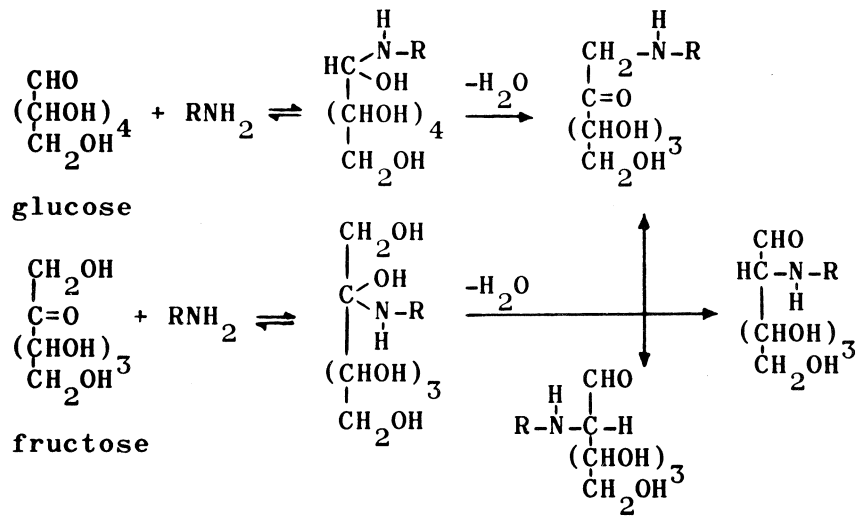

Abb. 5 Vereinfachtes Reaktionsschema, das die Umwandlung einer Amadorikomponente in Furane erklärt.

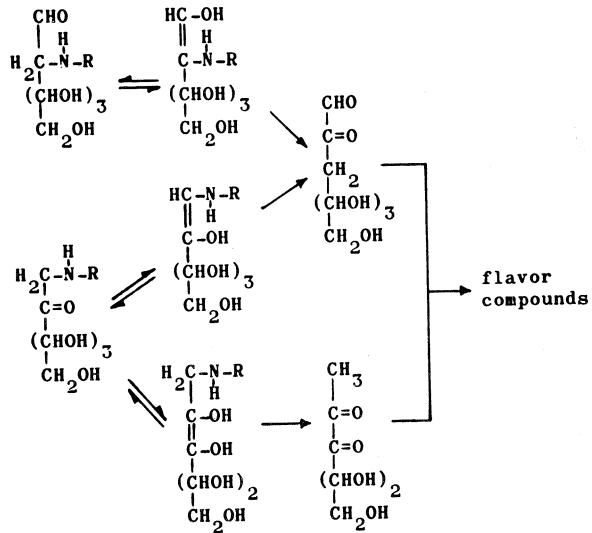

Abb. 6 Bildung von γ -Pyronen.

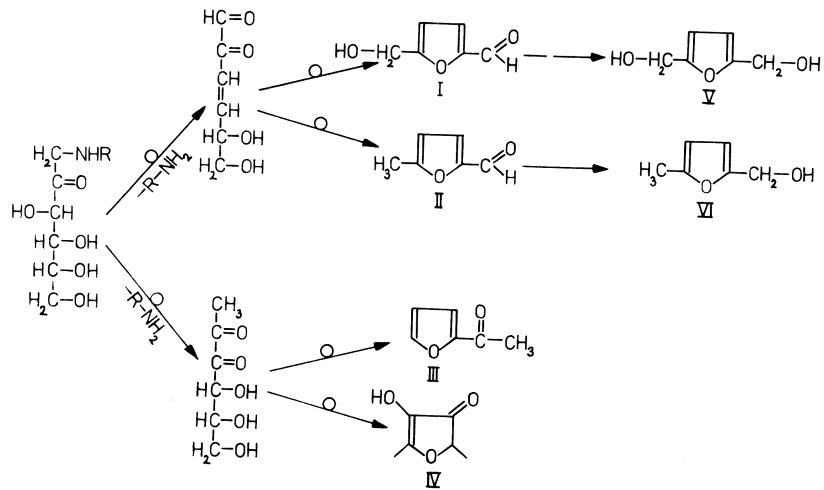

Abb. 7 Karamelkomponenten, die bei der thermischen Zersetzung von 1-Desoxy-1-L-proline-D-fructose entstehen (140°C).

Tabelle Gaschromatographisch-massenspektrometrisch charakterisierte Furan- und Pyronkomponenten in Röstkaffee und dunklem Malz (ppm)

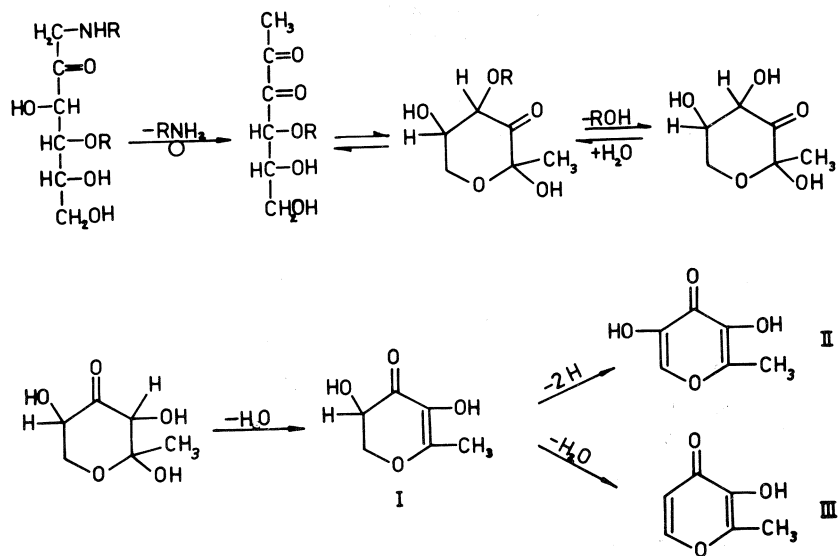
Komponente	Arabica	Robusta	Instant		Malz
			A	B	
1 HMF	35	10	70	200	5
2 Furaneol	48	26			5
3 Cycloten	40	26	70	110	3
4 Maltol	39	45	60	120	15
5 5-Hydroxymaltol	16	6			2,5
6 5-Hydroxy-5,6-dihydromaltol	13	9			60

Abb. 8 Karamelkomponenten in Röstkaffee und Malz.

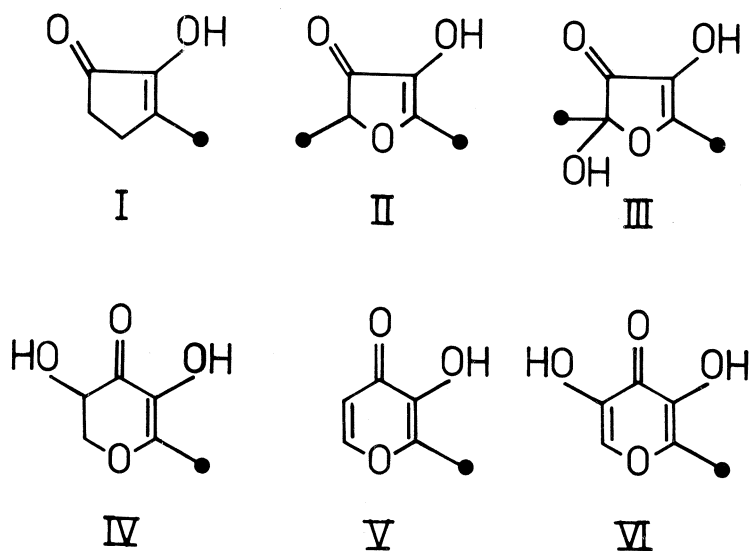

Abb. 9 Karamelkomponenten in Röstkaffee

- (I - III 3-(2H)-Furanone
 IV - VI 2-(5H)-Furanone
 VII - IX Pyranone
 X - XII Cyclopenten(hexen)one)

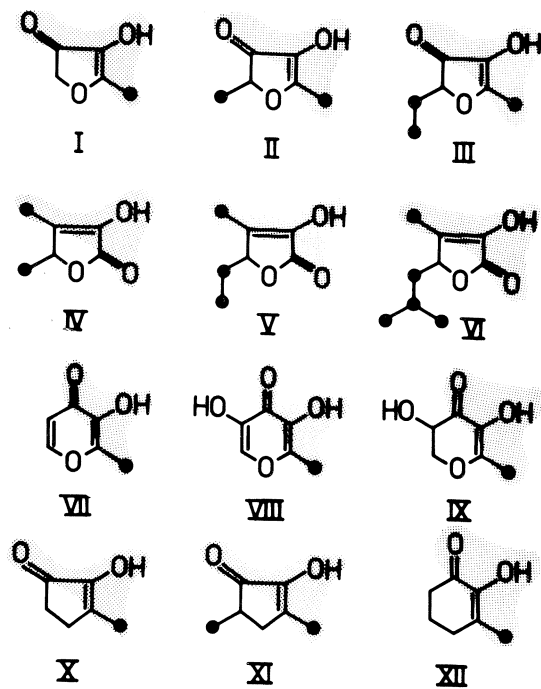

Abb. 10 Streckeraldehyde und 2-Phenylalkenale in Malz.

ROBUSTA INSTANT

	2,6	2,9
	0,3	1,4
	0,4	0,25
	+	0,41
	(ppm)	

Abb. 11 Streckeraldehyd des Phenylalanins und Folgeprodukte in Röstkaffee und Extraktkaffee.

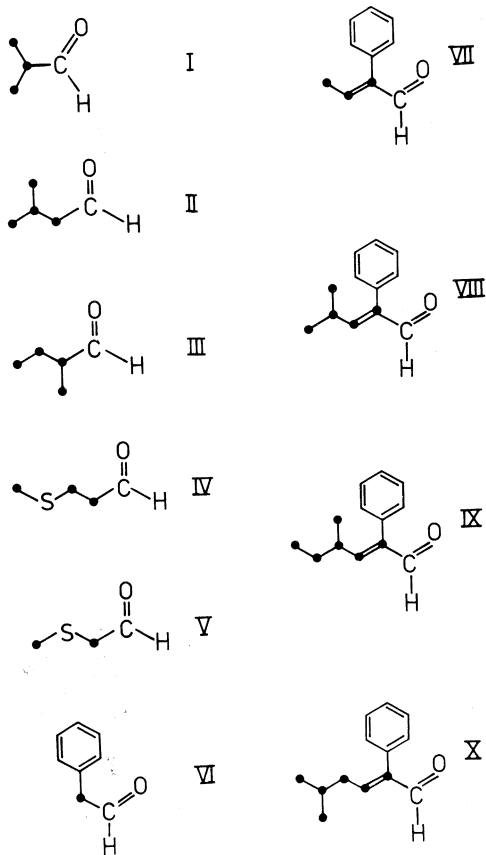

Abb. 12 Bildung von Verbindungen bei der thermischen Zersetzung von 1-Desoxy-1-L-prolino-D-fructose.

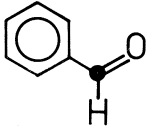
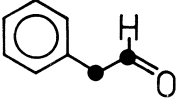
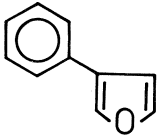
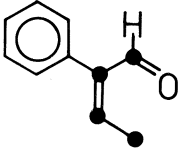

Abb. 13 Umwandlung von Hydroxyprolin in Aromastoffe.

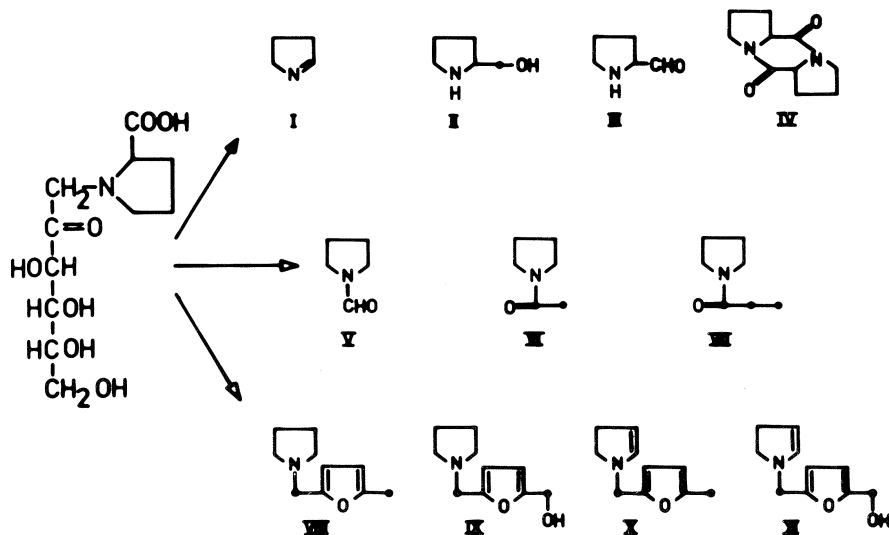

Abb. 14 Aromastoffe, die durch Umsetzung von Furfuraldehyd mit Valin entstehen.

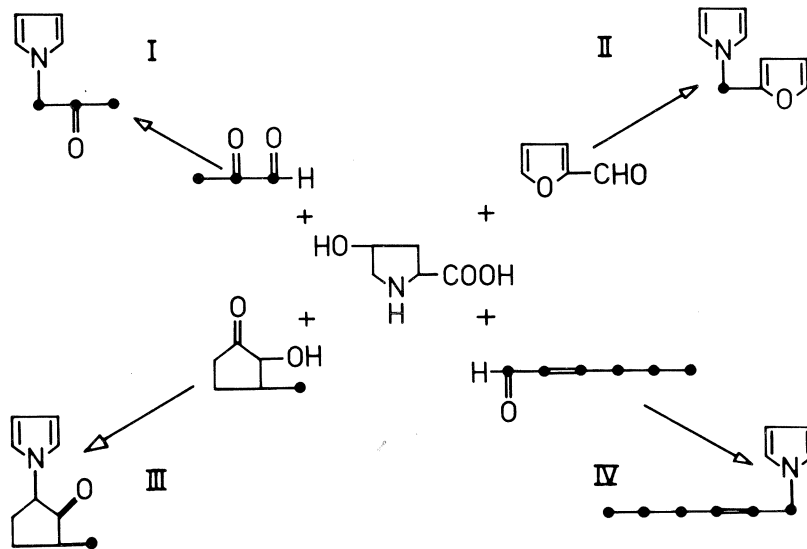

Abb. 15 N-Alkylpyrrole in Röstkaffee.

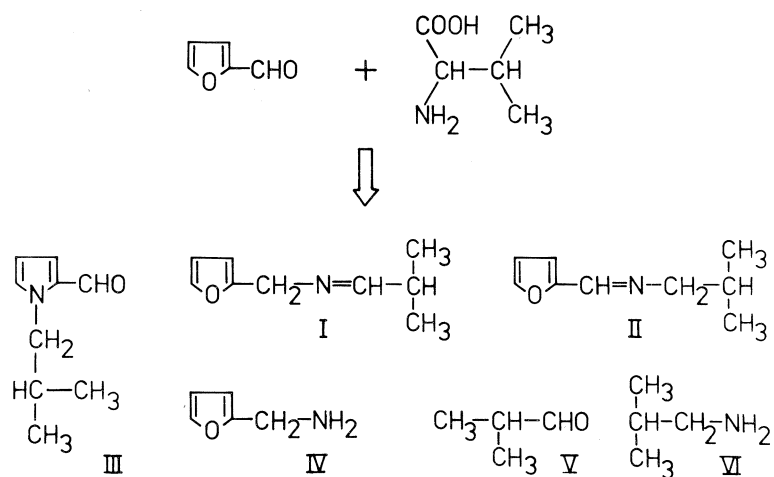

Abb. 16 N-Furfurylpyrrole in Röstkaffee.

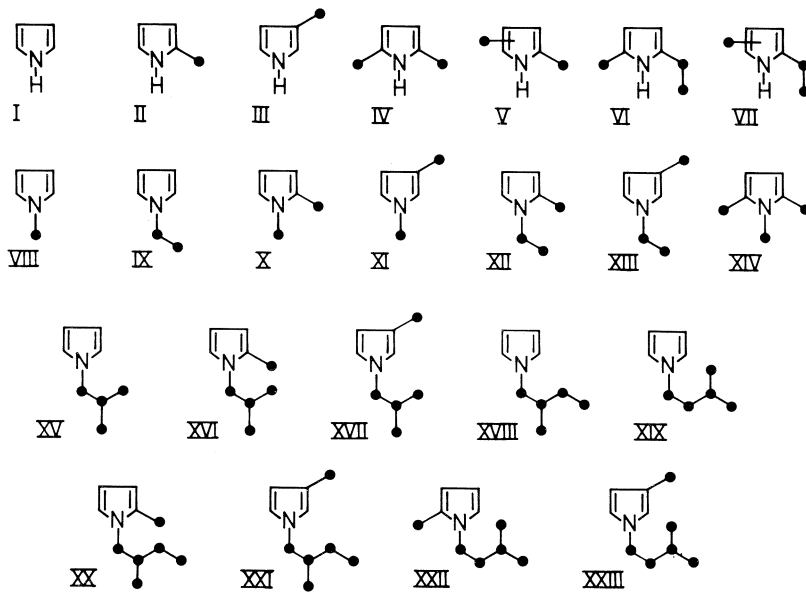

Abb. 17 Folgeprodukte des Streckerabbaus von Cys und Met in einem Furfural/Cys/Met/Modellsystem.



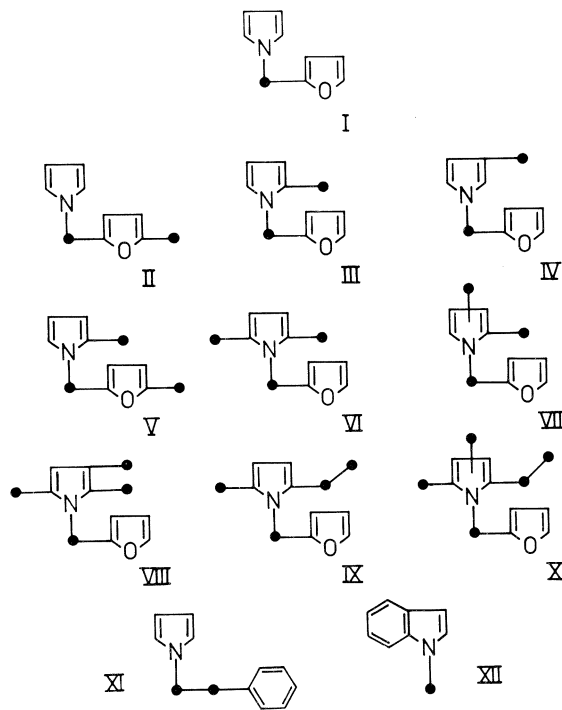



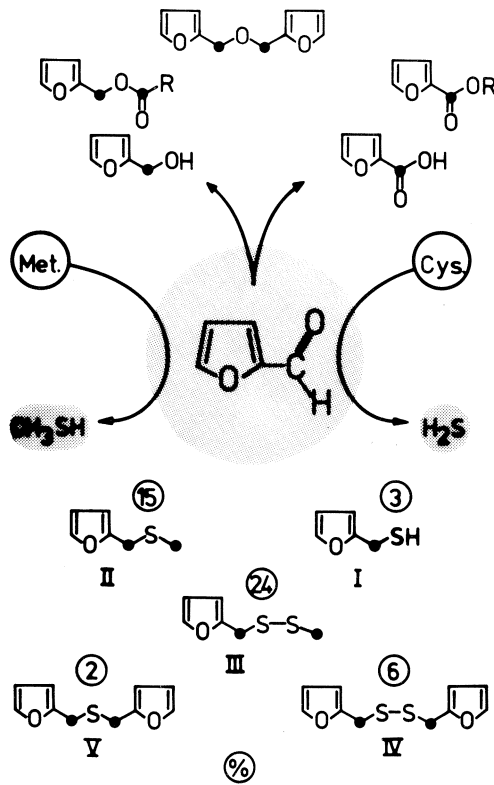



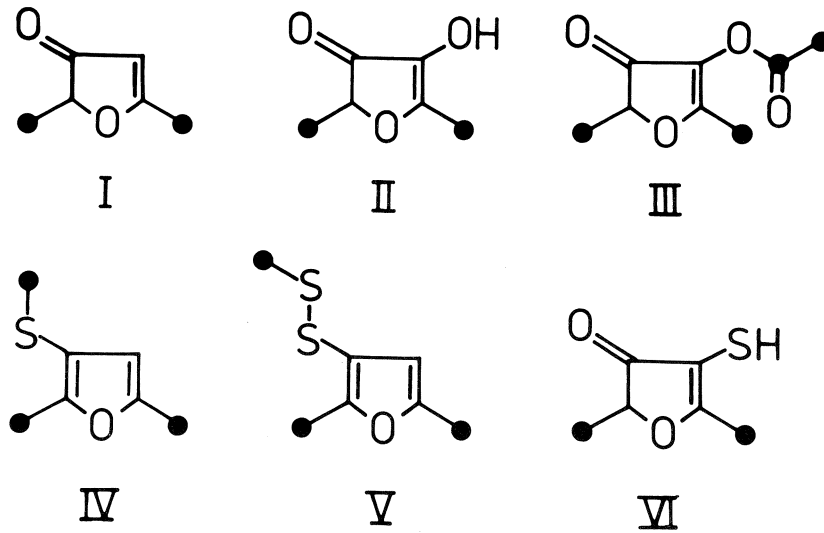



Abb. 18 Aromastoffe, die bei der Umsetzung von Rhamnose mit Cystein entstehen.

KOMPONENTE	ARABICA	ROBUSTA	INSTANT
	1100	2000	3900
	1100	2200	2800
	120	650	600
	190	110	10
	90	60	40
	30	20	15
	+	10	-
	60	130	-
	+	25	-
	+	10	-
	1160	850	600

(ppb)

Abb. 19 Schwefelhaltige Furanerivate in Röstkaffee.



Abb. 20 Schwefelhaltige Verbindungen, die in gealtertem Röstkaffee charakterisiert wurden.



Abb. 21 Veränderung von schwefelhaltigen Verbindungen während der Lagerung von Röstkaffee.

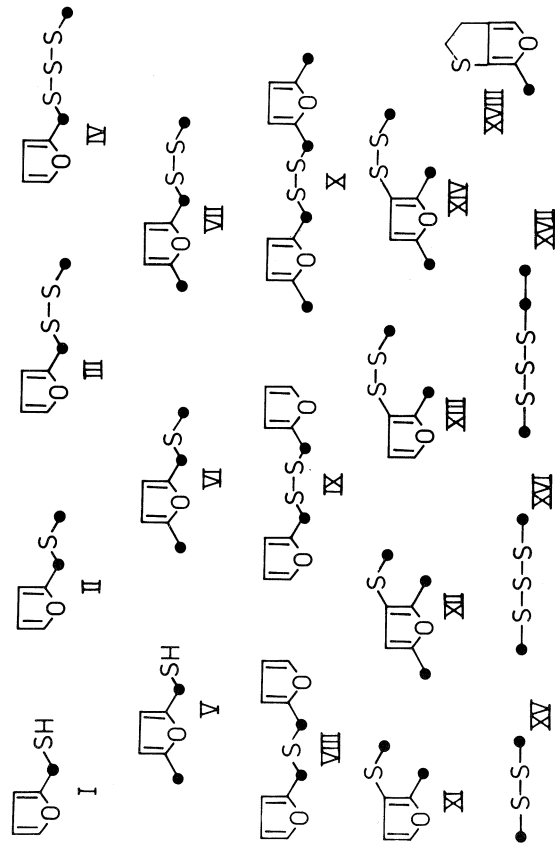

Abb. 22 Geruchsqualitäten und Schwellenwerte einiger Alkyl- und Alkoxy-pyrazine.

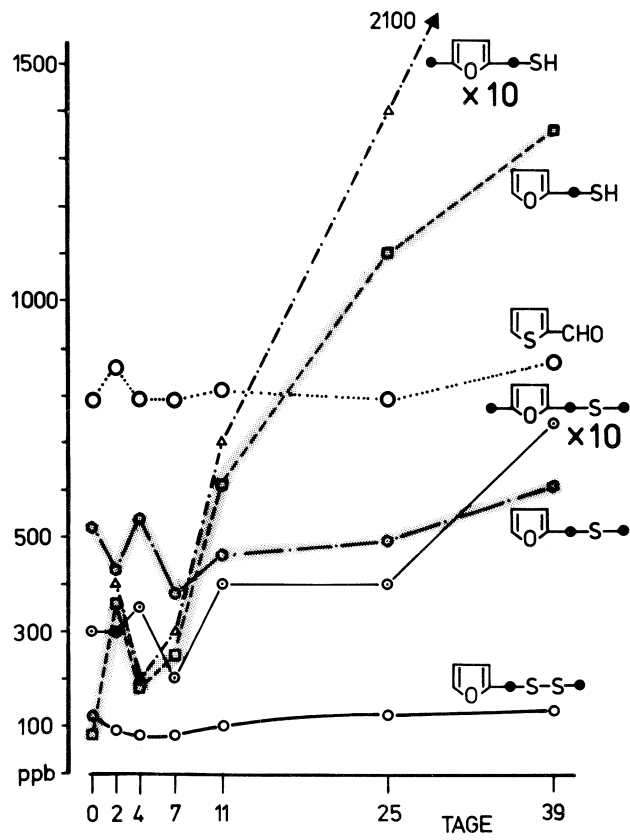

Abb. 23 Bildung von Alkyl-, Dihydrocyclopenta- und Furylpyrazinen.

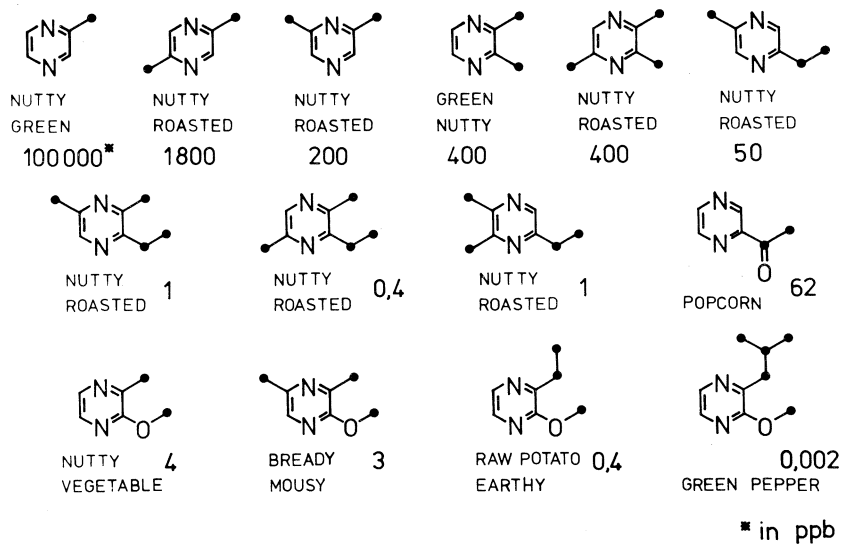

Abb. 24 Bildung von Thiazolen.

MODELLUNTERSUCHUNGEN ÜBER DIE AROMABILDUNG IN KAFFEE

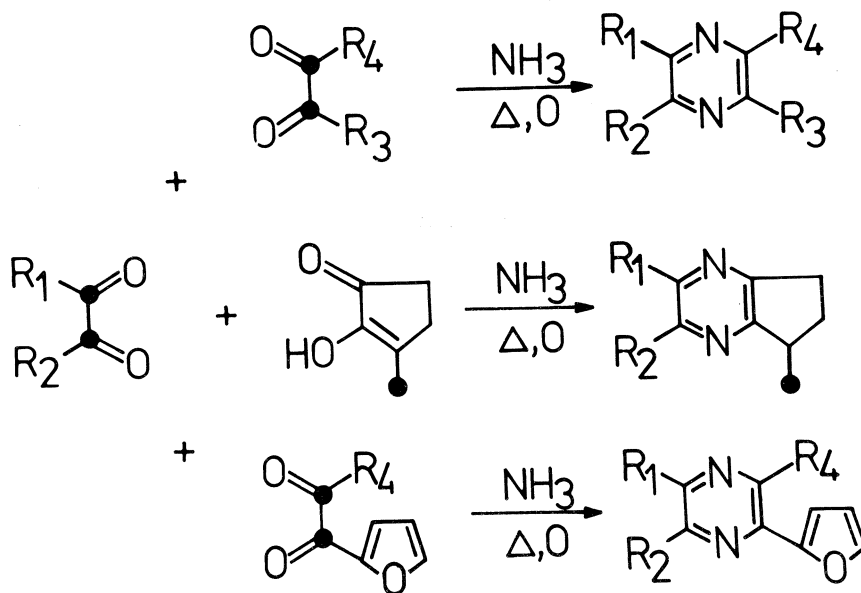

Lebensmittelchemikerin G. HERRMANN

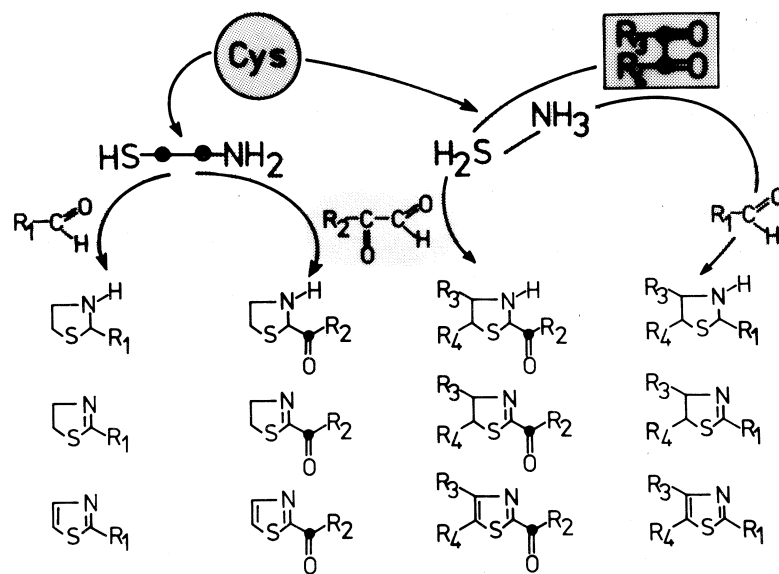
Prof. Dr W. BALTES

Technische Universität Berlin

Institut für Lebensmittelchemie

Müller-Breslau-Str. 10, D-1000 Berlin 12

Die Entstehung der Aromastoffe des Röstkaffees wird in erster Linie der Maillard-Reaktion zugeschrieben. Daneben werden aber auch pyrolytische Reaktionsmechanismen diskutiert, deren Abläufe jedoch noch weniger aufgeklärt sind als die Wege der Maillard-Reaktion (1, 2).

Wie wir wissen, werden im Verlauf der Kaffeeröstung die freien Aminosäuren ebenso wie die Monosaccharide und die Saccharose vollständig abgebaut. Wie wir nicht zuletzt aus den Arbeiten von Thaler (3) erfahren haben, durchläuft ein Teil der höhermolekularen Kohlenhydrate des grünen Kaffees während des Röstprozesses eine Reihe verschiedener Umwandlungen, während die im Eiweiß gebundenen Aminosäuren Abnahmen bis zu 30 % erfahren. Unter ihnen sind offenbar die basischen-, schwefelhaltigen- und Hydroxy-Aminosäuren am instabilsten, während neutrale und saure Aminosäuren eine Kaffeeröstung wesentlich besser zu überstehen scheinen.

Das Kaffeearoma ist ein typisches Beispiel für die vielfältigen Reaktionswege bei der thermischen Bildung von Lebensmittelaromen. Die Zusammenstellung und die Arbeiten von Vitzthum (4) zeigen sehr deutlich, dass im Kaffee Aromastoffe aus den unterschiedlichsten Substanzklassen der organischen Chemie vorkommen, deren sensorische Eigenschaften keineswegs immer an dieses edle Getränk erinnern.

Um einen Einblick in ihre Bildungsweisen zu erhalten, sind Modellreaktionen mit wenigen, ausgesuchten Reaktionspartnern notwendig, da die Informationen bei Vorliegen aller Reaktionsparameter unüberschaubar werden. Wir haben deshalb in einem Untersuchungsprogramm Saccharose mit der jeweils doppelt molaren Menge an Serin und Threonin unter Röstbedingungen bei 225°C zur Umsetzung gebracht und die flüchtigen Reaktionsprodukte untersucht. Serin und Threonin wurden gleichzeitig in die Reaktion eingesetzt, weil sie ohnehin in der Kaffeebohne nebeneinander vorliegen und weil wir auch glaubten, bei Umsetzung von Saccharose mit nur zwei Aminosäuren die Reaktionsprodukte noch genügend differenzieren zu können. Zur Auftrennung und Identifizierung der entstandenen Komponenten benutzten wir die Glaskapillar-Gaschromatographie in Kopplung mit der Massenspektrometrie.

Der Gang der Aufarbeitung ist schematisch in Abb.1 dargestellt:

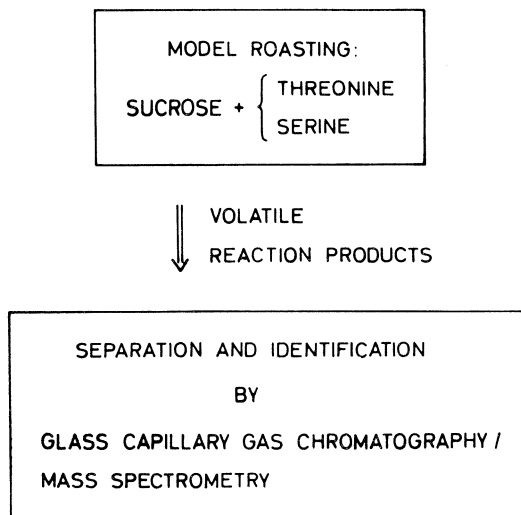

Zur Durchführung der Reaktion diente die in Abb.2 gezeigte Apparatur. Zum Rösten verwendeten wir ein Reaktionsrohr, das mit Heizmanschette und Kontaktthermometer versehen war. Es wurde mit einem homogenen Gemisch aus den Reaktionspartnern bei einem zusätzlichen Wassergehalt von etwa 10% gefüllt. Außerdem verhinderten geeignete Mengen von Quarzsand und Glaswolle ein Verkleben während der Reaktion und hielten somit das Rohr gasdurchlässig. Die Röstreaktion wurde mit einer Aufheizrate von 20°C/min. bis zu einer Endtemperatur von 225°C durchgeführt,



Abb. 2
Reaktionsapparatur zur Bildung und Isolierung von Kaffee-Röstaromen

bei der der Reaktionsansatz für weitere 10 min. belassen wurde. Die Reaktionsprodukte wurden mittels eines Stickstoffstroms von $50 \text{ cm}^3/\text{min.}$ in drei Kühlfallen mit Temperaturen von 20°C , 0°C und -170°C geleitet, wobei sich das freigesetzte Wasser vor allem in der ersten Kühlfalle abschied.

Aus den vereinigten Kondensaten wurde ein Etherextrakt hergestellt, der durch Kapillargaschromatographie getrennt wurde. Hierfür verwendeten wir eine mit Chlorwasserstoffgas geätzte und mit Carbowax TPA belegte Dünnschichtkapillare von 90 m Länge. Der splitlos aufgegebene Extrakt wurde nach Auftrennung über eine geschlossene Kopplung in die Ionenquelle eines Quadrupol-Massenspektrometers geleitet, das seinerseits an ein Rechnersystem angeschlossen war. Die Aufnahme der Massenspektren erfolgte nach der Elektronenstoß-Methode (Anregungsenergie 70 eV) mit einem zyklischen Scan von Masse 30 bis Masse 300, wobei die Scan-Zeit $0,8 \text{ Sekunden}$ betrug. Das bedeutet, daß alle $0,8 \text{ sec.}$ ein Spektrum erhalten wurde. Daß diese kurze Scan-Zeit notwendig war, dürfte an dem Gaschromatogramm des Extraktes ersichtlich werden (Abb.3).

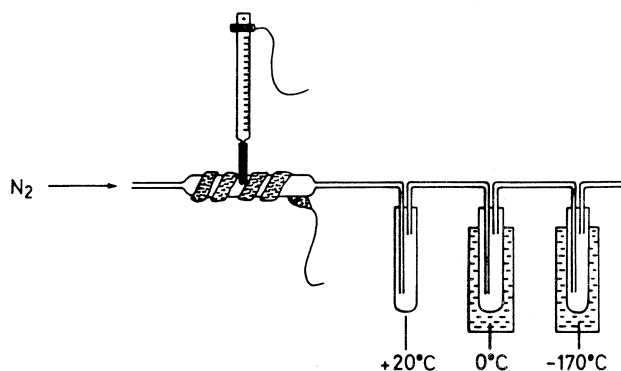

Abb.3

Gaschromatogramm der vereinigten Kondensate aus der Modellröstung von Saccharose mit Serin und Threonin

Temperaturprogramm: $10 \text{ min. } 40^\circ\text{C}$, $40\text{-}190^\circ\text{C}, 4^\circ\text{C}/\text{min.}$, $20 \text{ min. } 190^\circ\text{C}$

Darüber hinaus ermöglichte uns die schnelle Scan-Folge in Verbindung mit dem Rechnersystem in einigen Fällen die Differenzierung von Substanzen, die trotz der hohen Trennleistung der Kapillarsäule nicht getrennt worden waren.

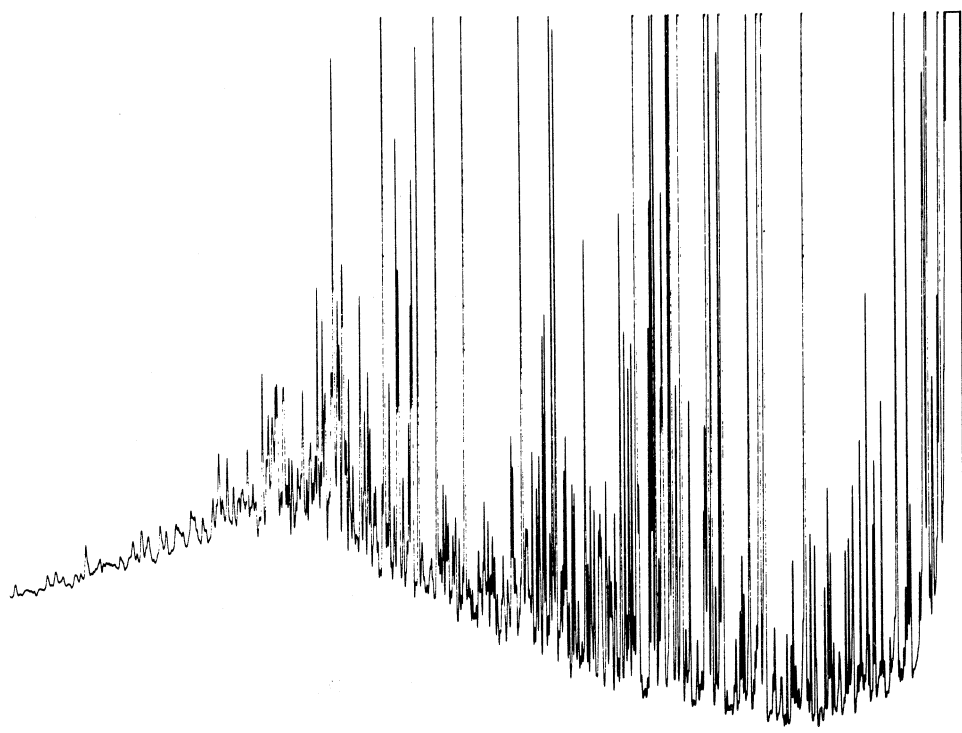
Die Problematik der Überlagerung von zwei Substanzen am Maximum eines äußerlich einheitlichen gaschromatographischen Peaks zeigt das Massenspektrum in Abb.4. Hier sind neben wenig intensiven Fragmentationen die Massen $m/e = 151$, 148 , 136 und 133 zu erkennen. Sinnvolle Fragmentierungen infolge Methylabspaltung ergeben jeweils nur die Massen $m/e = 151$ und $m/e = 136$ sowie $m/e = 148$ und $m/e = 133$, so daß das Spektrum offensichtlich zwei Substanzen zugeordnet werden muß. Mit Hilfe von Massenchromatogrammen auf speziellen Fragmentmassen kann dargestellt werden, daß die Massen mit sinnvoller Methylabspaltung



Abb. 4
Massenspektrum und Massenchromatogramme von zwei sich überlagernden Substanzen

übereinanderliegende Maxima bilden. Da diese Maxima lediglich um zwei Scans auseinanderliegen, unterscheiden sich die chromatographischen Trennzeiten der zu ihnen gehörenden Verbindungen nur um 1,6 sec. Bei diesen beiden Substanzen handelt es sich um 3,5-Dimethyl-6,7-dihydrocyclopentapyrazin und ein Alkylpyrrol, deren gemeinsames Peak-Maximum im Totalionenstrom-Signal durch Scan Nr.2095 dargestellt wird.

Allerdings gelang uns nicht immer die getrennte Erkennung von zwei in einem Peak enthaltenen Verbindungen. Diese Schwierigkeit bestand besonders dann, wenn sich ihre Fragmentierungsmuster scheinbar sinnvoll ergänzten oder charakteristische Fragmentationen von Spurenkomponenten in gleicher Intensität auch durch den Untergrund geliefert wurden.

Insgesamt entstehen bei dieser Reaktion etwa 400 verschiedene Komponenten, deren Gemisch sensorisch einen durch herbe Aromaten beeinflussten Röstaroma-Eindruck vermittelt. Von ihnen haben wir bisher 120 Verbindungen strukturell zugeordnet, wobei vor allem die Hauptkomponenten erfaßt wurden. Es handelt sich dabei durchweg um Heterozyklen aus den Verbindungsklassen der Pyrazine, Pyridine, Pyrrole, Chinoxaline und Furane, außerdem fanden wir ein Oxazol.

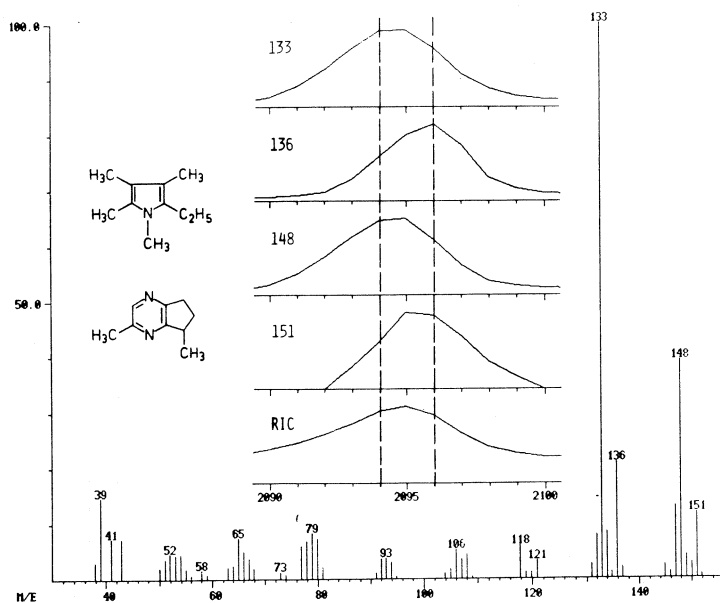
Interessant erschien uns eine Abschätzung der Mengenverhältnisse der gaschromatographisch getrennten Substanzen, die durch das Rechnersystem ermöglicht wurde. Zur Zeit ist die automatische Quantifizierung noch mit einem Fehler behaftet, da einerseits bei der Peakerkennung zwischen Untergrund und Spurenkomponenten nicht differenziert werden kann, andererseits nicht angezeigt wird, wieviele Verbindungen sich unter einem gaschromatographischen Peak verbergen. Überraschend war für uns jedoch, daß allein die Pyrazin-Derivate mengenmäßig 80 bis 85% des Gesamtextraktes ausmachen.

Abb.5 zeigt vier verschiedene Derivattypen von Pyrazinen, nämlich Alkylpyrazine, Alkenylpyrazine, Acetylpyrazine und Dihydrocyclopentapyrazine.



Abb. 5

In dem Reaktionsgemisch konnten insgesamt 35 Alkylpyrazine identifiziert werden, von denen 20 bereits aus früheren Untersuchungen des Kaffeearomas bekannt waren. Unter den von uns gefundenen Alkylpyrazinen befinden sich sowohl solche mit mehreren Methylgruppen, die offenbar isomer zu bereits beschriebenen Verbindungen sind, als auch Produkte mit Ethyl- und n-Propylresten als Seitenketten.

Unter den flüchtigen Reaktionsprodukten des Modellgemisches konnten außerdem 10 Alkenylpyrazine nachgewiesen werden, von denen Dimethylvinyl- und Dimethylpropenylpyrazine im Röstkaffeearoma noch nicht erwähnt worden sind. Neben zwei Acetylpyrazinen konnten außerdem 10 Dihydrocyclopentapyrazin-Derivate identifiziert werden, die indes fast alle schon im Röstkaffeearoma-Komplex gefunden worden sind.

Cyclopentapyrazine, die also noch eine Doppelbindung im zweiten Ringsystem enthalten, wurden im Röstkaffeearoma bisher überhaupt noch nicht nachgewiesen, sondern nur in gegrilltem Fleisch, in Bier und in Malz (5, 6). Wir fanden in unserem Gemisch neun derartige Komponenten, deren Aufbau schematisch in Abb.6 dargestellt ist. Wie den entsprechenden Dihydro-Verbindungen kommen auch ihnen röstähnliche Aromanoten zu. Anhand

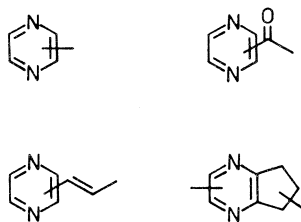

Abb. 6

von Referenzspektren glauben wir, mehrere Methylcyclopentapyrazine identifiziert zu haben, außerdem einige ihrer Dimethyl-, Ethyl- sowie Methylethyl-Derivate. Die verschiedenen Dimethylcyclopentapyrazine werden kapillargaschromatographisch zwar ohne Schwierigkeiten voneinander getrennt, jedoch ist eine Zuordnung der Stellungsisomeren ohne authentische Vergleichssubstanzen kaum möglich, da ihre massenspektrometrischen Fragmentierungsmuster nur sehr geringe Unterschiede aufweisen.

Ähnliche Probleme bestanden auch bei den Furylpyrazinen. Die drei von uns gefundenen Furylpyrazine sind im Röstkaffee Aroma bereits bekannt, allerdings kann die Stellung der Methylgruppe bei Furyl-methyl-pyrazinen anhand des Massenspektrums nicht exakt wiedergegeben werden.

Bei den Furan-Derivaten sind neben Methylfurfural und Furfurylalkohol hauptsächlich die Furylketone und -ester zu erwähnen, während an Pyrrol-Derivaten neben Pyrrol ausschließlich Alkyl- sowie Acetylpyrrole und Pyrrolaldehyde nachgewiesen werden konnten.

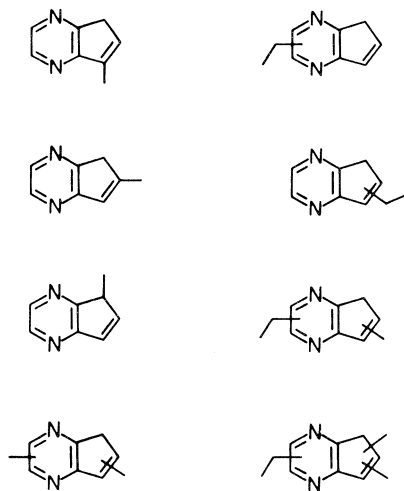
Überrascht waren wir über die Identifizierung von 10 Pyridinderivaten, deren Konzentration insgesamt ca. 0,5% der gesamten flüchtigen Komponenten ausmacht. Pyridinderivate sind als Bestandteile des Röstkaffee Aromas seit langem bekannt, jedoch wird für ihre Entstehung die thermische Umwandlung und Decarboxylierung des Trigonellins verantwortlich gemacht. Da aber in unserem Modellgemisch keine Pyridinderivate eingesetzt wurden, folgt somit, daß Pyridine offenbar auch durch thermische Umsetzung von Aminosäuren und Kohlenhydraten entstehen können. Hierauf weist auch die Entstehung von Pyridosin neben Furosins hin, die beide als Indikatoren für eine Eiweißschädigung durch Maillardreaktion bekannt geworden sind (7, 8). Außer den in Röstkaffee bereits bekannten Pyridin-Verbindungen konnten wir zusätzlich 3 Dimethylpyridine, 2,3,5-Trimethylpyridin und 2-Methyl-6-ethylpyridin identifizieren.

Da Hydroxyaminosäuren als wesentliche Vorläufer für die Oxazolbildung angesehen werden, erwarteten wir vor allem auch Oxazol-Derivate unter den flüchtigen Reaktionsprodukten. Interessanterweise gelang uns bis jetzt aber nur der Nachweis einer einzigen Komponente aus dieser Klasse, nämlich eines Methylethyl-oxazols. Auch dieses kam nur in Spuren vor, obwohl bei den Modellröstungen Saccharose mit der jeweils doppelt molaren Menge an Serin und Threonin umgesetzt worden war. Auch mit Hilfe von Massenchromatogrammen auf den speziellen Fragmentmassen von alkylierten Oxazolen war keine weitere derartige Verbindung zu identifizieren. Natürlich war zu vermuten, daß auch höhermolekulare Kohlenhydrate unter Röstbedingungen zur Aromabildung des Kaffees beitragen können. Um das zu untersuchen, haben wir aus grünem Kaffee Galactomannan und Galactoaraban isoliert und diese ebenfalls unter den beschriebenen Bedingungen mit Serin und Threonin zur Umsetzung gebracht.

Das Gaschromatogramm der erhaltenen Röstaroma-Kondensate zeigte indes weitgehende Übereinstimmung mit dem des Saccharose-Ansatzes, dennoch müssen noch einige Anstrengungen unternommen werden, um alle gebildeten Reaktionsprodukte zu identifizieren. Interessanterweise waren die Konzentrationen an Aromastoffen aus beiden Ansätzen schätzungsweise gleich groß.

In Weiterführung solcher Überlegungen tauchte nun die Frage auf, wie sich ein Gemisch aus Threonin und Serin ohne Kohlenhydratzusatz unter Röstbedingungen verhält. In Abb.7 ist das Gaschromatogramm einer gemeinsamen Modellröstung von Threonin und Serin dargestellt, das wiederum die Anwesenheit zahlreicher Reaktionsprodukte anzeigt. Obwohl eine Kohlenhydratkomponente bei dieser Modellreaktion nicht zugegen war, beträgt der Anteil der Alkyl- und Alkenylpyrazine unter den flüchtigen Reaktionsprodukten nach bisherigen Ergebnissen trotzdem 30 bis 35%, während Cyclopenta-, Acetyl- und natürlich Furylpyrazine nicht identifiziert werden konnten. Neben den Pyrazinen enthält die Modellmischung Pyrrol-Derivate als Hauptkomponenten. Der Anteil der Pyridin-Verbindungen im Gesamtextrakt liegt unter 0,5%, Oxazol-Derivate konnten wiederum nicht gefunden werden. Da in



Abb.7

Gaschromatogramm der vereinigten Kondensate aus einer Modellröstung von Serin und Threonin

Temperaturprogramm: 10 min.40°C, 40-190°C, 4°C/min., 20 min.190°C

diesem Modellgemisch die Zuckerkomponente fehlt, kann die Bildung von Alkylpyrazinen offensichtlich auch über andere Reaktionsmechanismen als die Maillard-Reaktion und den Strecker'schen Abbau ablaufen.

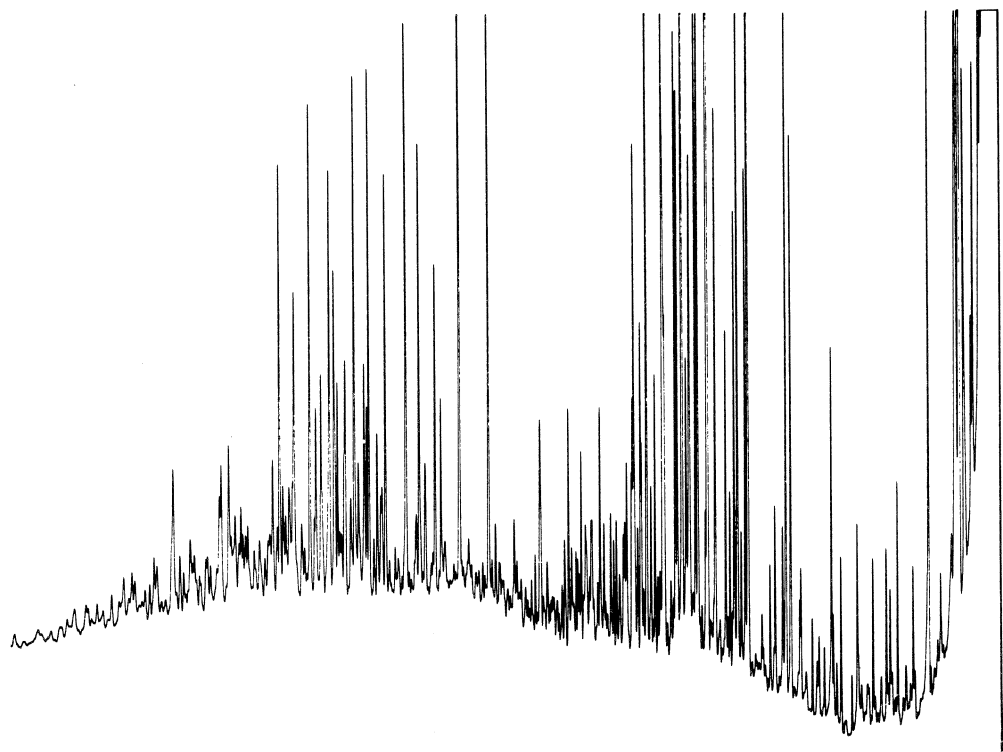
Wir müssen demnach erkennen, daß offenbar viele Verbindungen von Röstaromen ausschließlich durch pyrolytische Reaktionen gebildet werden, über deren Mechanismus allerdings bisher nur lückenhafte Kenntnisse vorliegen. Es wird daher noch viel Arbeit notwendig sein, bis wir alle Reaktionswege der Entstehung des Kaffeearomas kennen.

Die Veröffentlichung der massenspektrometrischen Daten ist in der "Zeitschrift für Lebensmittel-Untersuchung und -Forschung" vorgesehen.

Der Deutschen Forschungsgemeinschaft danken wir für die finanzielle Unterstützung dieser Arbeit, Herrn Blaas und Herrn Dr. Kellert vom Bundesgesundheitsamt Berlin möchten wir für die Bereitstellung des Massenspektrometers und für die Unterstützung bei der Datenaufnahme danken.

LITERATUR

- 1.) BALTES, W.: ASIC, 7^e Colloque, Hamburg, 91-107 (1975).
- 2.) BALTES, W.: ASIC, 8^e Colloque, Abidjan, 85-96 (1977).
- 3.) THALER, H.; ARNETH, W.: ASIC, 3^e Colloque, Triest, 127-136 (1967).
- 4.) VITZTHUM, O.G. in Eichler, O.: Kaffee und Coffein, Springer-Verlag, 1976.
- 5.) FLAMENT, I.; SONNAY, P.; WILLHALM, B.; OHLOFF, G.: Helvetia Chimica Acta 59, 2314-2326 (1976).
- 6.) TRESSL, R.; RENNER, R.; KOSSA, T.; KÖPPLER, H.: Proc.Europ.Brew.Conv. 16th Congr., Amsterdam 1977, Elsevier, Amsterdam 1977, p.693.
- 7.) HEYNS, K.; HEUKESHOVEN, J.; BROSE, K.H.: Angew.Chem. 80, 626 (1968).
- 8.) FINOT, R.; VIANI, J.; BRICOUT, J.; MAURON, J.: Experientia 25, 134 (1969).

LA CHROMATOGRAPHIE LIQUIDE HAUTE PERFORMANCE APPLIQUÉE À CERTAINS CONSTITUANTS SPÉCIFIQUES DU CAFÉ

H. R. MOLL, G. A. PICTET
Société d'Assistance Technique
pour les Produits Nestlé
CH-1350 Orbe

Introduction

La chromatographie liquide "haute performance" ou "haute pression" est connue en tant que technique analytique exploitable depuis pratiquement une décennie. Les applications pratiques de cette technique, qui dépendaient principalement des améliorations technologiques apportées aux équipements disponibles par les constructeurs spécialisés, sont beaucoup plus récentes. Dans les laboratoires de notre Société, la chromatographie "haute performance" est devenue rapidement un instrument de travail indispensable, comme le démontre par exemple l'étude dont les résultats essentiels vont être présentés.

Cette étude a été entreprise en poursuivant plusieurs objectifs indépendants :

- a) Explorer les possibilités offertes par la chromatographie "haute performance" pour les contrôles globaux exercés dans le domaine du café, vert ou torréfié, et de ses extraits.
- b) Examiner de manière approfondie le problème particulier des acides aliphatiques et phénoliques présents dans le café et de certains de leurs composants.
- c) Etablir une corrélation éventuelle entre le comportement de ces substances spécifiques et celui de certains caractères sensoriels

au cours de l'opération de torréfaction.

Partie expérimentale

Préparation des échantillons

Les extraits de café vert destinés à l'analyse chromatographique ont été préparés par simple décoction de la matière première convenablement moulu au moyen d'eau déionisée et bidistillée. Pour les extraits de café torréfié, la technique de filtration par gravité continue, décrite dans une communication antérieure (1), a été appliquée, les proportions relatives de produit torréfié et de fluide d'extraction étant semblables à celles utilisées pour une infusion ménagère. Les différents extraits représentatifs ont été examinés dans le quart d'heure suivant leur préparation, après un refroidissement préalable.

Séparations chromatographiques

La chromatographie liquide "haute performance" a été exercée en phase inversée, ce qui signifie que les produits à séparer étaient répartis entre une phase stationnaire fortement apolaire et une phase mobile consistant en un mélange de solvants de plus en plus apolaire. Pour les extraits considérés, la phase stationnaire était un gel de silice dont les fonctions hydroxyles avaient été estérifiées par des groupements octyliques ou octodécyliques. Les solvants mélangés étaient l'eau distillée (élément polaire), utilisée à l'état pur ou légèrement additionnée d'acide phosphorique, et le nitrile acétique (élément apolaire). Le solvant apolaire figurait dans le mélange dans une proportion variant entre 5 % en début de séparation et 45 % après 40 minutes de gradation linéaire, soit pratiquement à la fin de l'analyse.

Remarque

Une estimation précise des divers acides aliphatiques n'a pu être établie par une chromatographie directe des extraits ou des infusions, en raison de leur apparition massive en début de séparation. Il fut donc indispensable de les transformer en leurs esters de phénacyle pour pallier cet important inconvénient.

Evaluations sensorielles

Les infusions correspondant aux divers produits torréfiés ont été présentées à un jury de dégustateurs, soit en tant qu'échantillon unique, soit en comparaison par paire avec une infusion de référence. L'appréciation par les juges des boissons qui leur étaient soumises a été faite en utilisant une échelle de notation de 7 points et en prenant en considération 14 critères de qualité, se rapportant à leurs propriétés

aromatiques et savoureuses. L'ensemble de ces évaluations qualitatives a fait l'objet d'une analyse mathématique multidimensionnelle, dont les modalités ont été présentées dans une communication antérieure (1).

Discussion des résultats

Recherche d'un domaine optimal d'absorption

Les effluents de la séparation chromatographique, qui contiennent les substances éluées successivement de la phase stationnaire, ont été contrôlés au moyen d'un détecteur à absorption ultra violette. En variant la longueur d'onde de mesure, il est possible de mettre particulièrement en évidence certains des constituants spécifiques de l'extrait examiné.

Aux environs de 324 nm, les différents acides phénoliques, depsides des acides caféique et férulique et porteurs du groupement chromophore de l'acide cinnamique polyhydroxylé, sont responsables des principaux pics présents dans le profil chromatographique schématisé en figure 1.

Figure 1 Profil chromatographique de l'extrait aqueux d'un café vert de Kenya, mesure à 324 nm

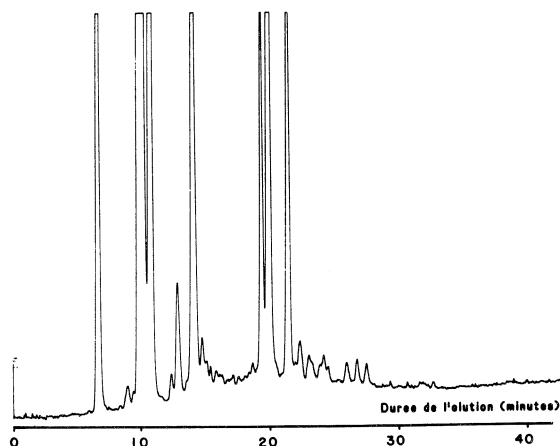

Dans le domaine proche de 280 nm, le nombre des pics discernables augmente de plusieurs unités, en raison de l'apparition de la caféine, de la trigonelline et de plusieurs composés aromatiques possédant des doubles liaisons conjuguées dans leurs chaînes latérales, comme le montre le profil présenté en figure 2.

Le passage à 224 nm augmente encore le nombre de pics figurant dans le profil (se reporter à la figure 3), puisque la presque totalité des substances possédant une activité mesurable dans l'ultra violet absorbent dans un domaine proche de cette longueur d'onde.

Figure 2 Profil chromatographique de l'extrait aqueux d'un café vert de Kenya, mesure à 280 nm

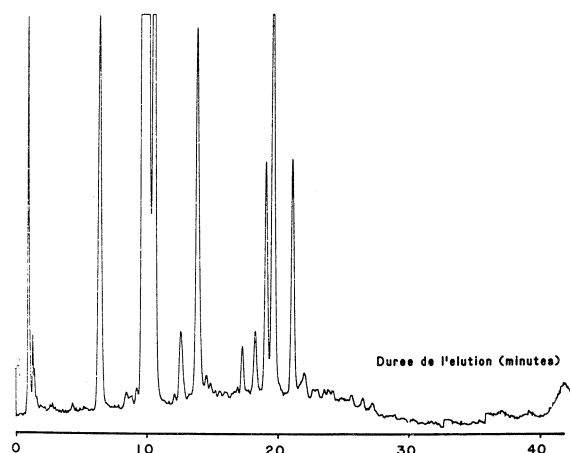
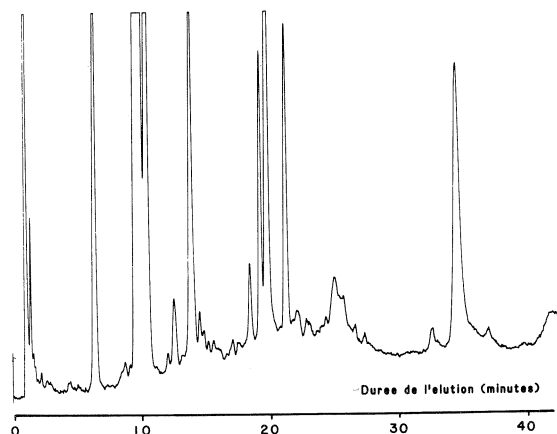

Figure 3 Profil chromatographique de l'extrait aqueux d'un café vert de Kenya, mesure à 224 nm



Remarque

Au cours des travaux consacrés à la recherche d'une zone optimale d'absorption, l'efficacité de la technique analytique employée a été contrôlée. Il s'est avéré que la chromatographie "haute performance" peut être considérée comme une méthode rapide, précise et reproductible, qui procure toujours des profils de séparation parfaitement résolus. Elle peut être appliquée aussi bien aux extraits et infusions déjà envisagés qu'à des produits instantanés d'origine commerciale.

Influence des origines du café

Une comparaison des profils chromatographiques mesurés à 324 nm permet d'établir une différence appréciable entre deux cafés verts

représentant chacun une espèce botanique bien définie. L'extrait provenant du café d'Angola (espèce canephora) contient plusieurs composants qui sont pratiquement absents de l'extrait découlant du café du Kenya (espèce arabica), comme le montrent les profils des figures 4 et 5. Il pourrait s'agir entre autres de depsides de l'acide coumarique, qui ont été identifiés à plusieurs reprises dans des cafés appartenant à l'espèce canephora (2,3). Au sein d'une même espèce, des différences comparables, quoique parfois moins évidentes, peuvent être relevées entre des cafés d'origines botaniques et géographiques distinctes.

Figure 4 Profil chromatographique de l'extrait aqueux d'un café d'Angola, mesure à 324 nm

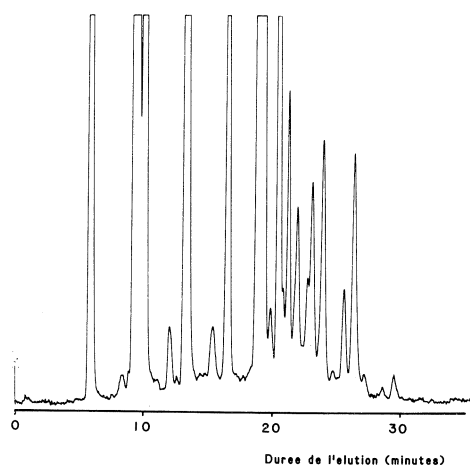
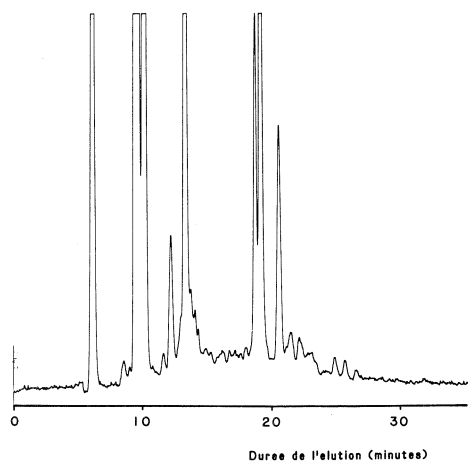

Figure 5 Profil chromatographique de l'extrait aqueux d'un café de Kenya, mesure à 324 nm



Influence du degré de torréfaction

L'opération de torréfaction est responsable de changements

substantiels dans la composition du café qui la subit, comme le démontrent les profils chromatographiques reproduits dans les figures 6 à 8. On assiste tout d'abord à une diminution assez marquée de la plupart des pics principaux, ainsi qu'à l'apparition simultanée de pics moins importants, présents à l'état de traces en début de traitement. La disparition progressive de la majorité des pics se poursuit ensuite, qui ne laisse subsister dans le profil examiné qu'un grand pic isolé, qui correspond à la caféine si l'on se base sur les expériences de superposition décrites dans les paragraphes qui suivent. De petites quantités des isomères de l'acide chlorogénique sont également présentes à la fin du traitement technologique.

Figure 6 Profil chromatographique de l'extrait aqueux d'un café vert de Kenya, mesure à 280 nm

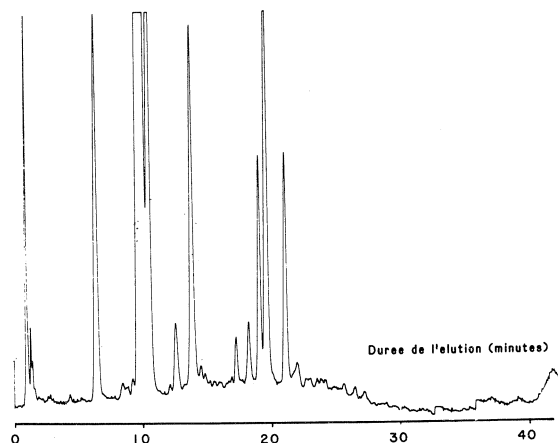

Figure 7 Profil chromatographique de l'infusion d'un café de Kenya faiblement torréfié, mesure à 280 nm

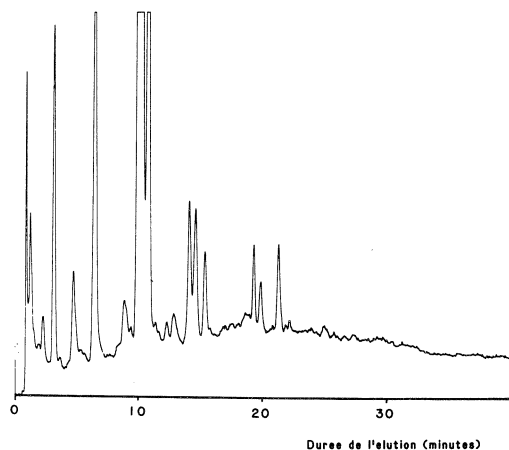
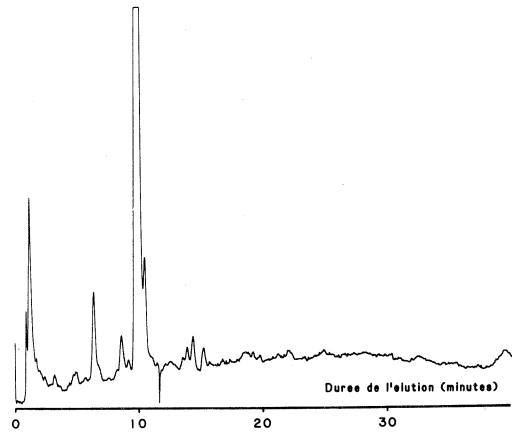

Figure 8 Profil chromatographique de l'infusion d'un café de Kenya fortement torréfié, mesure à 280 nm



Evaluations sensorielles

Les quotations numériques attribuées par le jury de dégustateurs à une série d'échantillons procédant d'un degré de torréfaction de plus en plus poussé ont été soumises à une analyse canonique. Cette analyse a permis de placer les attributs déterminants des produits dégustés, c'est à dire les propriétés aromatiques et sapides retenues, dans un espace multidimensionnel. D'une manière comparable, les infusions évaluées ont été situées dans le même espace mathématique.

Pour simplifier l'interprétation des résultats, la structure obtenue a été projetée selon les deux axes principaux, procurant ainsi des enseignements approchant à près de 90 % la réalité mathématique (1).

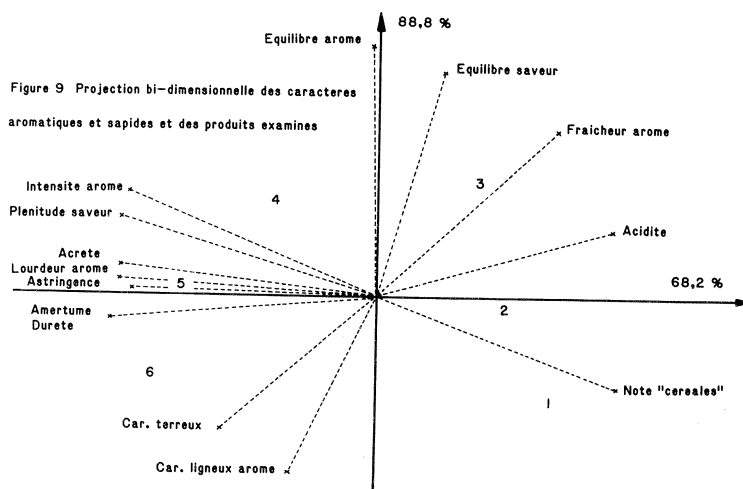

D'après la projection reproduite dans la figure 9, le premier axe correspond clairement au degré de rôtissage et aux variables qui lui sont associées, la torréfaction la plus faible se situant en direction positive et la plus forte en direction négative de cet axe. Le deuxième axe exprime plutôt l'équilibre général des propriétés aromatiques et sapides des diverses infusions dégustées, en insistant particulièrement sur la fraîcheur de l'arôme (direction positive) et sur le caractère ligneux de ce dernier (direction négative).

Un des principes sensoriels les plus étroitement corrélés avec le degré de torréfaction est l'acidité naturelle de l'infusion, indissolublement liée à une impression générale de finesse et de fraîcheur. L'évolution de ce caractère particulier a été évaluée à nouveau par le jury concerné, en utilisant cette fois une échelle de notation plus étendue. Cette évolution a été représentée dans la figure 10 en fonction du degré de torréfaction, exprimé par la perte au feu du café traité.

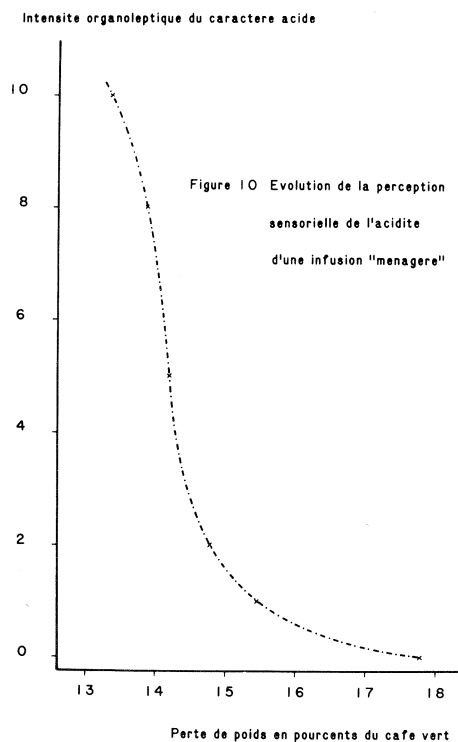

La forme particulière de la courbe est d'ailleurs caractéristique indiquant nettement qu'une diminution substantielle de cet attribut essentiel se produit déjà en début de traitement.

Comportement des acides phénoliques

Les principaux acides phénoliques identifiés précédemment dans le café, c'est à dire les différents acides chlorogéniques, ont été mis en évidence dans les profils chromatographiques par simple renforcement de leur teneur dans les extraits ou les infusions injectés. La position de ces constituants du café dans les chromatogrammes est indiquée dans la figure 11 pour un café moyennement torréfié.

Figure 11 Profil chromatographique de l'infusion d'un café de Kenya moyennement torréfié, mesure à 324 nm

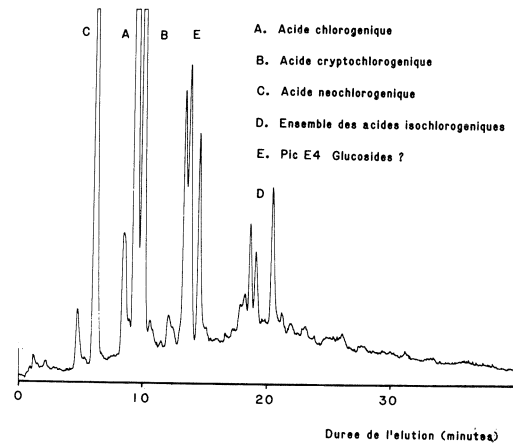

L'ensemble des pics rassemblés sous la lettre "E" se rapporte probablement à des substances glucosidiques à aglucone phénolique, puisque ces composés disparaissent rapidement lorsque l'extrait est traité par un mélange d'enzymes spécifiques, tirés de "helix promatia".

L'opération de torréfaction se traduit par une diminution particulièrement marquée des acides phénoliques, comme le montrent les courbes rassemblées dans la figure 12. L'acide chlorogénique proprement dit, qui est pondéralement le plus important des depsides considérés, subit une réduction extrêmement marquée, en raison d'une isomérisation qui se produit pendant la partie initiale du traitement technologique. Les glucosides présumés, pour leur part, résistent mieux aux processus de dégradation et leur teneur décroît de manière beaucoup plus atténuée. Une analogie certaine doit être relevée entre la courbe qui représente la disparition progressive de l'acidité organoleptique et celles qui reproduisent la décroissance des acides phénoliques, en particulier pour l'acide chlorogénique proprement dit. Dans l'état d'avancement actuel de nos travaux, il serait cependant prématuré de prétendre qu'une corrélation réelle existe entre ces deux phénomènes.

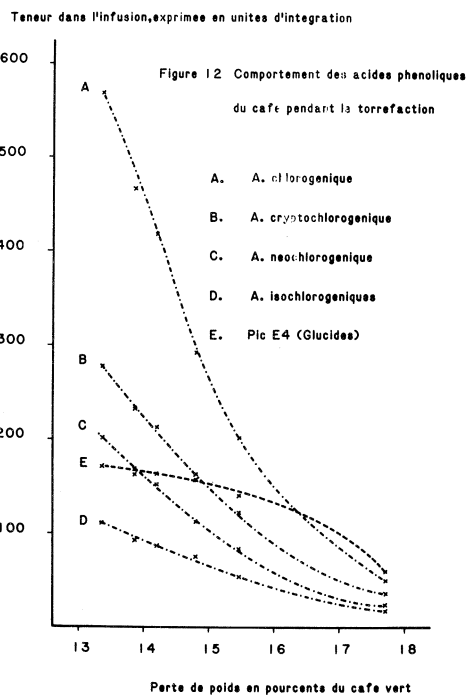

Comportement des acides aliphatiques

L'emplacement dans les chromatogrammes des acides aliphatiques identifiés auparavant dans le café ou ses extraits a été déterminé en utilisant la technique de renforcement déjà évoquée, pratiquée avec des substances pures.

Figure 13 Profil chromatographique des esters de phénacyle de l'infusion d'un café de Kenya moyennement torréfié, mesure à 243 nm

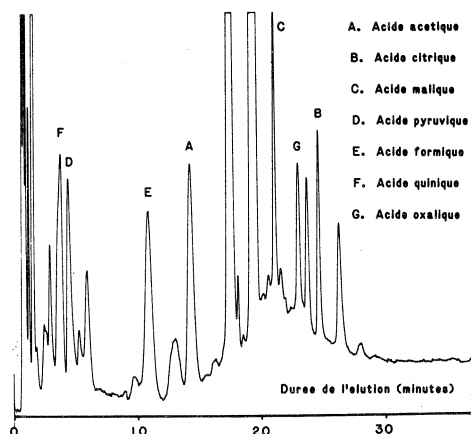

L'identité et la position de ces constituants dans les profils a été reproduite dans la figure 13; un des principaux pics dont l'identification n'a pas été précisée correspond d'ailleurs à un excès de bromure de phénacyle, utilisé comme réactif d'estérification.

Comme on peut s'en convaincre en examinant les courbes rassemblées dans la figure 14, le comportement en cours de rôtissage des acides aliphatiques est fondamentalement différent de celui des acides phénoliques.

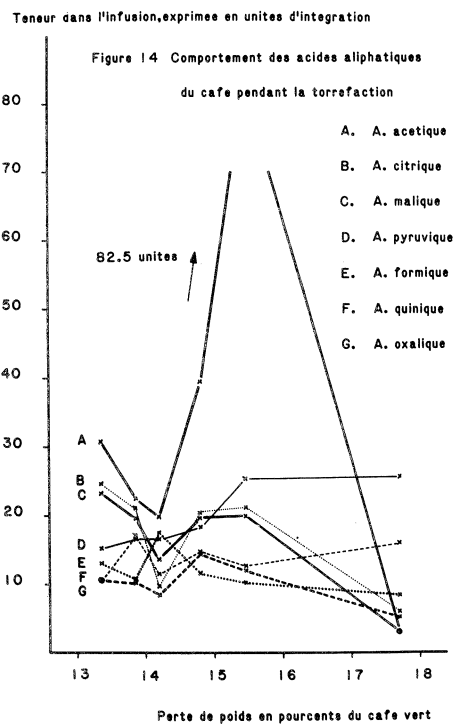

Certains d'entre eux, comme les acides citrique, malique et acétique, subissent en effet une réduction notable de leur teneur pondérale, surtout à la fin de l'opération, mais le processus de cette réduction ne se produit pas de manière régulièrement dégressive. Les autres constituants examinés sont peu modifiés par le traitement technologique et aucune comparaison entre leur comportement et celui du caractère sensoriel ne peut être établie.

Nous adressons tous nos remerciements à Monsieur L. Vuataz, pour l'assistance très efficace qu'il nous a apportée lors du traitement mathématique des évaluations sensorielles, et à Mademoiselle G. Pratz, pour sa collaboration pratique très appréciée tout au long de l'étude décrite dans cette présentation.

Conclusions

Les applications diverses de la chromatographie liquide "haute performance" qui ont été exercées dans nos laboratoires ont pleinement démontré qu'il s'agit d'une technique rapide, précise et reproductible, qui procure des profils de séparation complètement résolus.

L'injection directe d'extraits de grains verts ou d'infusions de grains torréfiés permet d'établir une nette distinction entre les principales espèces de cafés et également entre certaines variétés botaniques et géographiques.

L'opération de torréfaction se traduit par des modifications profondes du profil chromatographique, dont l'importance quantitative pourrait certainement être utilisée pour le contrôle analytique de cette dernière.

Les acides chlorogéniques, principaux constituants phénoliques du café, subissent en particulier une réduction sensible de leur teneur en cours de rôtissage. Une certaine analogie existe entre le déroulement de cette réduction et celui de la disparition progressive de la notion sensorielle d'acidité, sans que l'on puisse vraiment parler d'une corrélation.

Le comportement des acides aliphatiques du café en fonction de l'accroissement du degré de torréfaction est extrêmement complexe et aucun processus logique ne peut être établi à son sujet.

Références bibliographiques

- 1) G.Pictet et L.Vuataz 8^e Colloque sur la Chimie des Cafés, Abidjan 1977, ASIC (Paris) 1979, p. 261-269
- 2) G.Pictet et H.Brandenberger J.Chromatography 4.396 (1960)
- 3) K.Rubach Thèse de Doctorat, Université de Berlin, 1969

EVIDENCE FOR COMPLEX FORMATION BETWEEN THIAMINE AND THE CHLOROGENATE ION IN AQUEOUS SOLUTION

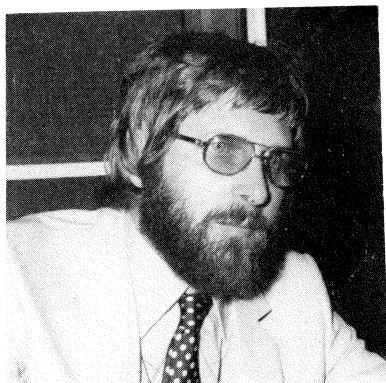

I. HORMAN, R. A. CARPENTER

E. BRAMBILLA, B. DREUX

Nestlé Research Laboratories

CH-1814 La Tour-de-Peilz

2,3-Dihydroxycinnamic acid, better known in coffee circles as caffeic acid, was reported some years ago to be a naturally occurring antithiamine agent¹. Its deactivation of thiamine to an extent of 95 % was thought to be due to its *ortho*-dihydroxybenzene moiety, in that other compounds bearing this group were also active². Among the related substances tested was chlorogenic acid, an ester of caffeic acid, which was shown to have the same deactivating effect on thiamine as did caffeic acid itself. Coffee provides one of the main sources of chlorogenic acid in our diet, so studies on thiamine deactivation were extended to "in vivo" experiments on the effects of coffee drinking in a group of human volunteers. Somogyi and Nägeli presented results where, for almost all volunteers studied, the quantity of thiamine excreted in the urine after drinking coffee was less than after drinking the same amount of water: this was taken as evidence for an antithiamine effect of coffee³. At the time of these studies, the various investigators were unable to find definite proof of an interaction between thiamine and chlorogenate, and no breakdown products were detected in the urine, but it was postulated that chlorogenate formed some kind of a complex with thiamine, thus deactivating it⁴.

With this as a background, we began our own investigations of the thiamine-chlorogenate system with two aims in mind:

- to determine the nature of the interaction, if any, between the two compounds;
- to see if any such interaction was strong enough to support the theory of deactivation through complexation.

MEASUREMENT OF COMPLEX STRENGTH BY NUCLEAR MAGNETIC RESONANCE SPECTROSCOPY

A complex may be defined as a loosely bound agglomeration of two or more molecules which dissociates more or less readily into its separate constituents. Thus, for a complex (ChTi) forming from chlorogenate (Ch) and thiamine (Ti) according to the equation:

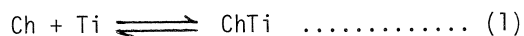

an equilibrium is established where the concentrations of Ch, Ti and the complex ChTi are defined by the Law of Mass Action expression in terms of K, the association constant.

$$K = \frac{[\text{ChTi}]}{[\text{Ch}] \cdot [\text{Ti}]} \dots\dots\dots (2)$$

Larger values of K correspond to the formation of greater quantities of the complex, and hence to a higher complex strength.

The proton nmr spectrum of a compound consists of a series of peaks whose positions reflect the 3-dimensional spatial disposition of hydrogen nuclei in the molecule. Spectra therefore provide a picture of molecular structure as shown in Figure 1 where we see the spectra of thiamine and chlorogenate separately in aqueous solution. More specifically, peak positions are determined by the different levels of electron density in the various parts of the molecule. In general, protons in regions of high electron density give peaks on the right of the spectrum as presented, and those in low electron density regions show up on the left.

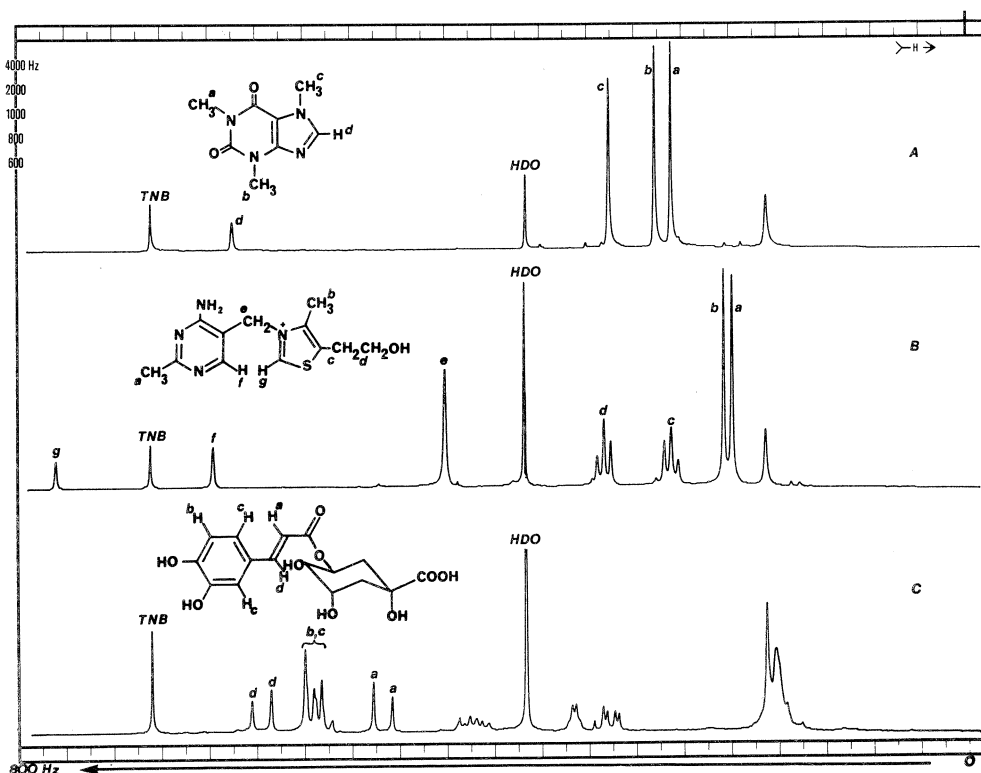

Figure 1 The 80 MHz ¹H nmr spectra of (A) caffeine, (B) thiamine, (C) potassium chlorogenate, in D₂O solution. S-Trinitrobenzene in a capillary insert is used as an internal reference standard.

When a complex forms between two compounds in solution, the electron density of each component is modified by the presence of the other. This means that peak positions also change between two theoretical limits which represent the situation when no complex is formed and when the pure complex is present. Under experimental conditions, neither of these situations arises, and we measure peak positions, δ_{obs} , relative to a reference compound, TMS, which lie between positions δ_0 for the "zero complex" and δ_{∞} for the "pure" complex. This is shown schematically in Figure 2 which defines δ_0 , δ_{obs} , δ_{∞} , Δ_{exp} and Δ_c .

Here, Δ_{exp} is the complexation induced displacement and Δ_c the maximum theoretical displacement.

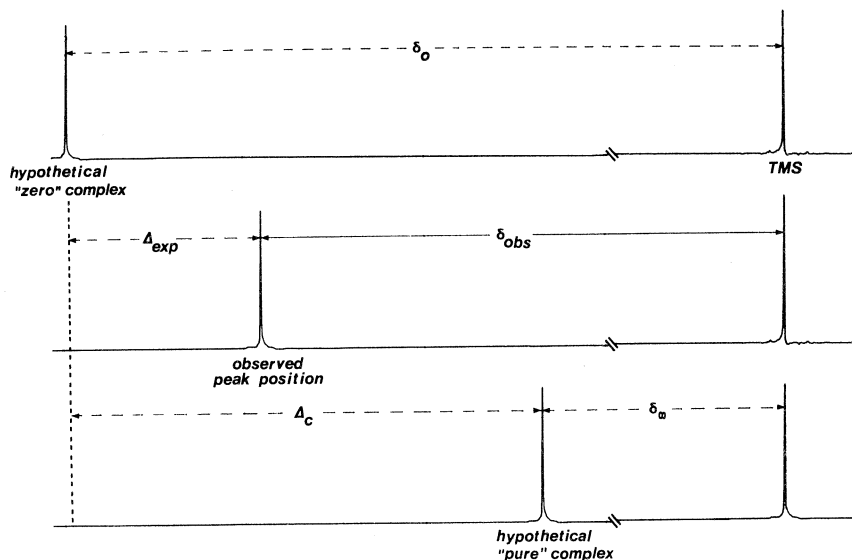

Figure 2 The definitions of chemical shifts δ_0 , δ_{obs} and δ_{∞} and of the complexation induced displacements Δ_{exp} and Δ_c of an nmr absorption in a π -complexing species as concentration is varied.

The displacement Δ_{exp} for chlorogenate peaks is proportional to the amount of complex present in solution relative to total chlorogenate concentration. For equimolar solutions of thiamine and chlorogenate it is related to Δ_c according to the following equation:

$$\frac{\Delta_{\text{exp}}}{\Delta_c} = \frac{[\text{ChTi}]}{[\text{Ch}]_0} = \left(\frac{[\text{ChTi}]}{[\text{Ti}]_0} \right) \text{ since } [\text{Ch}] = [\text{Ti}] \dots\dots(3)$$

From equation 2, we see that $[\text{ChTi}]$ is not linearly related to $[\text{Ch}]$ or $[\text{Ti}]$. For this reason, peak displacements on complexation are also non-linear with respect to chlorogenate and thiamine concentration as indicated in Figure 3. The exact relationship for solutions where $[\text{Ch}]_0 = [\text{Ti}]_0$ can be derived by combining equations 2 and 3 to give equation 4.

$$\Delta_{\text{exp}} = \delta_0 - \delta_{\text{obs}} = \frac{\Delta_c \cdot \left\{ (2 K_{\text{ChTi}} \cdot [\text{Ch}]_0 + 1) - (4 K_{\text{ChTi}} \cdot [\text{Ch}]_0 + 1)^{1/2} \right\}}{2 K_{\text{ChTi}} \cdot [\text{Ch}]_0} \dots (4)$$

For a series of equimolar solutions of chlorogenate and thiamine at different concentrations, a curve-fitting computer program based on equation 4 was developed to calculate optimum values of K_{ChTi} , δ_0 and Δ_c by fitting the experimental data of $\delta_{\text{obs}} \nu [\text{Ch}]_0$.

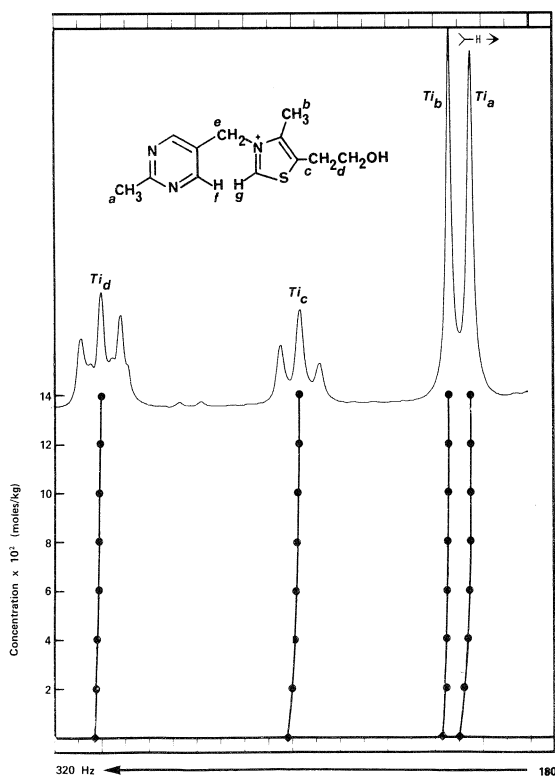
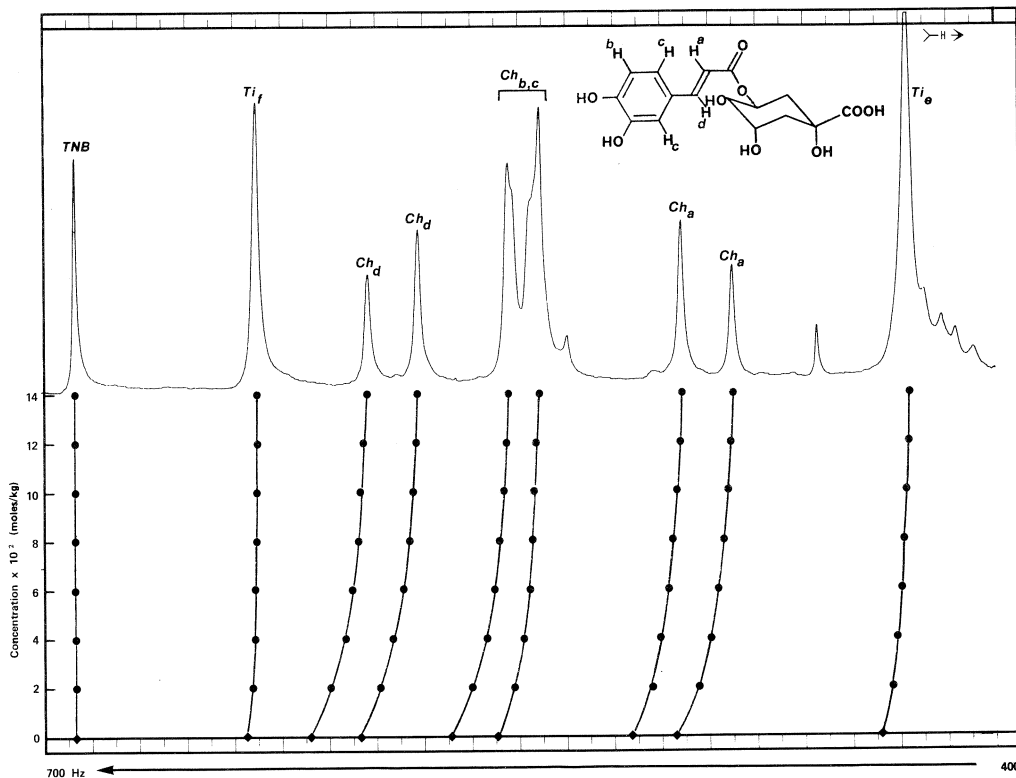

Figure 3 The 80 MHz ^1H nmr spectrum of an equimolar mixture of thiamine and potassium chlorogenate at 0.14 moles/kg D_2O solution relative to TNB as an internal standard. Displacements of peaks as the solution is diluted are shown (●—●) under the potassium. Thiamine peaks are indicated as Ti and chlorogenate peaks as Ch. Peak positions in the chlorogenate ion (upper structure) and thiamine (lower structure) are indicated as subscripts a, b, c, etc.

EXPERIMENTAL PROCEDURE

A solution at pH 5.5 containing chlorogenate (Fluka) and thiamine (Merck) both at approximately 0.15 M/kg was prepared by dissolving equimolar amounts of potassium chlorogenate and thiamine in enough D₂O (Stohler Isotope Chemicals) to give a total weight of 25 g. Aliquots of this solution were diluted accurately by weight with pure D₂O to give a series of equimolar solutions with concentrations ranging from about 0.005 M/kg to 0.15 M/kg. The nmr spectra of all of the samples prepared were then run at 30.5°C on a Varian FT-80A nuclear magnetic resonance spectrometer using Fourier transform signal averaging techniques. The average positions from 100 spectral scans were calculated for each sample relative to an *s*-trinitrobenzene capillary standard⁵, and reported relative to the line position of tetramethylsilane for which $\delta = 0$ by definition.

The curve-fitting program based on equation 4 was then used over the experimental concentration range to calculate K_{ChTi} , δ_0 and Δ_c from displacements of several peaks in both the thiamine and the chlorogenate spectra.

THE NATURE OF THE COMPLEX AND COMPLEX STRENGTH

Figure 3 shows the proton nmr spectrum of an equimolar mixture of chlorogenate and thiamine, both at about 0.14 M/kg D₂O solution. The displacements of several spectral lines as a function of concentration are also shown, and we can see that as concentration increases, peaks are displaced to the right. Some peaks are displaced more than others, but most of them are displaced to some degree. The non-linear displacement of these signals with respect to concentration confirms that a complex is indeed formed and the net displacement to the right, indicative of an overall increase in electron density at all positions in the complex, points to π -rather than σ -bonding between thiamine and chlorogenate. A likely conformation for the complex is indicated in Figure 4 which suggests that molecules are lined up such that the caffeic acid moiety of chlorogenate gives a π -molecular interaction with the pyrimidine ring of the thiamine, and the negatively charged carboxyl group of chlorogenate interacts with the positively charged thiazole ring of thiamine, which still retains its positive charge.

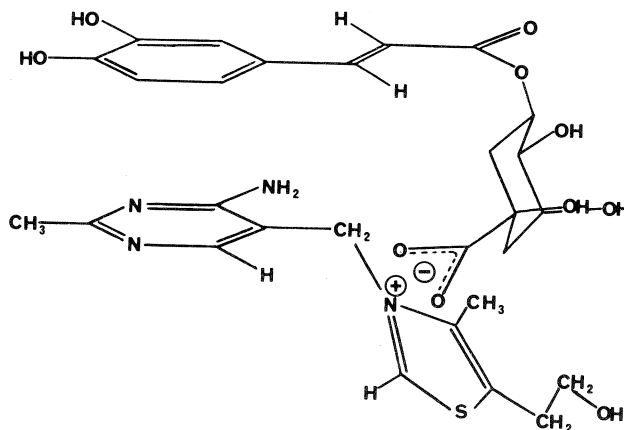

Figure 4 A possible mode of association of thiamine with the chlorogenate ion.

Values of complex strength calculated from the non-linear displacements of Figure 3 are presented in Table 1 as K_{ChTi} values: corresponding values of δ_0 and Δ_C are also given. It is seen that whether we consider chlorogenate or thiamine peak displacements, the values of K_{ChTi} calculated agree remarkably well. For some of the thiamine peaks where total displacements are small, the agreement is less good, but this may be expected in that for small displacements, the degree of confidence in the experimental data is also less.

On average, we can estimate that the association constant for the chlorogenate - thiamine complex is about 14 kg/mole, comparable to the association constant which we reported earlier for the caffeine - chlorogenate complex occurring naturally in coffee⁵.

To assess the influence of caffeine on the extent of complex formation between thiamine and chlorogenate, we also studied the interaction between caffeine and thiamine, and the extent of dimerization of thiamine, chlorogenate and caffeine. These results are summarized in Figure 5.

We see that, relatively speaking, dimerization is of little importance, and that caffeine has no direct influence on thiamine. It will, however, have an indirect influence on the amount of complex formation between chlorogenate and thiamine in that it complexes a part of the chlorogenate, thus reducing the concentration of free chlorogenate in the mixture. This in turn will reduce the amount of thiamine complexed, but only by a few percent.

EXTRAPOLATION OF THESE RESULTS TO COFFEE

What do these results mean in the context of coffee and its effect on thiamine? Can we use them to explain all of the reported data both "in vivo" and "in vitro" on caffeic acid, chlorogenic acid and coffee?

Coming back first to our original question of whether a complex forms, we have shown that this is the case and that its strength is about that of the caffeine - chlorogenate complex. Consuming 1 litre of coffee at the normal chlorogenate level of 0.5 - 2 g/litre, which is two to three orders of magnitude greater than our daily level of thiamine consumption, we can calculate from the association constant of 14 kg/mole that only 2 - 8 % of the thiamine we take into the body would be complexed, the major part therefore being free of complexation.

Assuming a regular daily intake of thiamine of 1.5 - 2.5 mg, we can estimate for a level of complexation of 2 - 8 % that about 30 - 200 μ g of the thiamine we consume would be complexed. Literature results on the quantitative reduction in urinary thiamine output after drinking 1 litre of coffee³ indicate an average reduction in the urine collected over an eight hour period of 85 μ g. Taking into account variations between the volunteers used in these experiments, actual reductions lie between 0 and 250 μ g. The figures for both the amount of thiamine our results would predict to be complexed and the "in vivo" reduction in thiamine output after drinking coffee agree remarkably well.

A further important point is that the complex is reversibly formed: we may therefore speculate as to whether the non-excreted thiamine is not biologically available.

Thus, our results would support an "in vivo" inactivation of 2 - 8 %, which even if it were shown to be irreversible is not particularly significant unless our diet is already thiamine-deficient. However, our results can in no way be stretched to explain the 95 % thiamine deactivation reported "in vitro" for pure chlorogenic acid. This is a point which we are presently investigating in greater detail.

Table 1 Values of K_{ChTi} , Δ_c and δ_o for the thiamine-chlorogenate complex in aqueous (D_2O) solution at $35^\circ C$ calculated from concentration dependent displacements of proton nmr absorption peaks of both thiamine and chlorogenate.

Peak No. *	δ_o (Hz from TMS)	K_{ChTi} (kg/m)	Δ_c (Hz)	Av. dev. from data
Thiamine peaks				
a	200.88	16.2	7.45	0.073
b	205.60	16.6	4.46	0.051
c	251.74	10.9	9.64	0.048
d	308.22	14.1	5.41	0.060
e	438.41	12.8	21.81	0.065
f	635.10	19.9	4.60	0.059
Chlorogenate peaks				
a	500.71	14.49	36.44	0.114
a	516.76	14.85	36.34	0.110
b	555.87	13.84	25.61	0.092
c	565.06	10.64	42.33	0.091
c	573.09	13.74	41.19	0.111
d	601.67	14.19	41.72	0.105
d	617.57	13.71	41.30	0.104

* Correlation between peak No. and proton position in the individual molecules is shown in the structural formulae for thiamine and chlorogenate in figure 1.

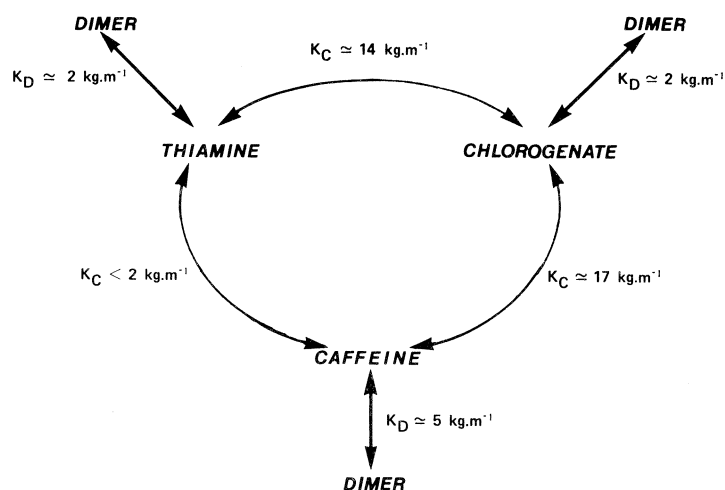

K_C : association constant for heterogeneous complex

K_D : association constant for dimer

Figure 5 Relative association constants for complexes involving caffeine, thiamine and chlorogenate.

In conclusion, extrapolating our results directly to physiological concentrations of thiamine and chlorogenate, we would estimate that the amount of chlorogenate consumed in coffee would not have a marked effect on thiamine levels in the body because the complex itself is not strong enough, and we must ask whether it is really true that coffee exerts an antithiamine effect.

REFERENCES

1. J. Berüter and J.C. Somogyi, *Experientia*, 1967, 23, 996
2. J.C. Somogyi and R. Bönicke, *Internat. J. Vit. Res.*, 1969, 39, 65
3. J.C. Somogyi and U. Nägeli, *Internat. J. Vit. Res.*, 1967, 46, 149
4. J.C. Somogyi, in "Toxicants Occurring Naturally in Foods", ISBN 0-309-02117-0, Natural Academy of Sciences, Washington DC, 1973, p. 254
5. I. Horman and R. Viani, "Proceedings of the 5th ASIC Colloquium", Lisbon, 1971, p. 102; *J. Food Sci.*, 1972, 37, 925

ANALYSIS OF CHLOROGENIC ACIDS IN COFFEE

G. H. D. VAN DER STEGEN, J. VAN DUIJN

Douwe Egberts, R. and D.,

Utrecht, the Netherlands

A. Introduction

The group of chlorogenic acids constitute about 8% of the green coffee and about 3% of the roasted coffee. So far there are very few analytical techniques available to analyse individual components of this group (1-4). High performance liquid chromatography (HPLC) is thought to be a technique capable of analysing these individual components. For some natural products HPLC analyses of plant phenolics including chlorogenic acids have already been reported (5-10). The nomenclature as proposed by Clifford (4) will be used in this paper.

B. Equipment and Materials

Following chromatographic equipment has been used in this study: Dupont 830 HPLC (with gradient facility), Valco 7000 injection valve, Chrompack Spherisorb 5-ODS column (1.15 cm, I.D. 4.6 mm) and Pye Unicam L.C.-U.V. detector.

Samples of reference components either were bought commercially (Roth, Karlsruhe) or were kindly supplied by Dr. Clifford and Dr. Nagels.

C. Analytical Procedure

1. Sample preparation

Coffee samples have been prepared by grinding and subsequent exhaustive extraction with water in a Moulinex espresso coffee brewing machine. These aqueous extracts have been filtered over a Millipore filter and subsequently injected into the chromatograph. These extraction conditions might induce some isomerisation between the several isomers within the group of chlorogenic acids. However, imitation of the extraction conditions by heating an extract showed that the individual components changed only a few percent.

2. Chromatographic procedure

For the chromatographic resolution it was chosen to use a so called reverse phase column and an aqueous eluent containing citrate buffer and methanol. As an example of the optimization of these chromatographic parameters the effect of the methanol content in the eluent is shown in figure 1.

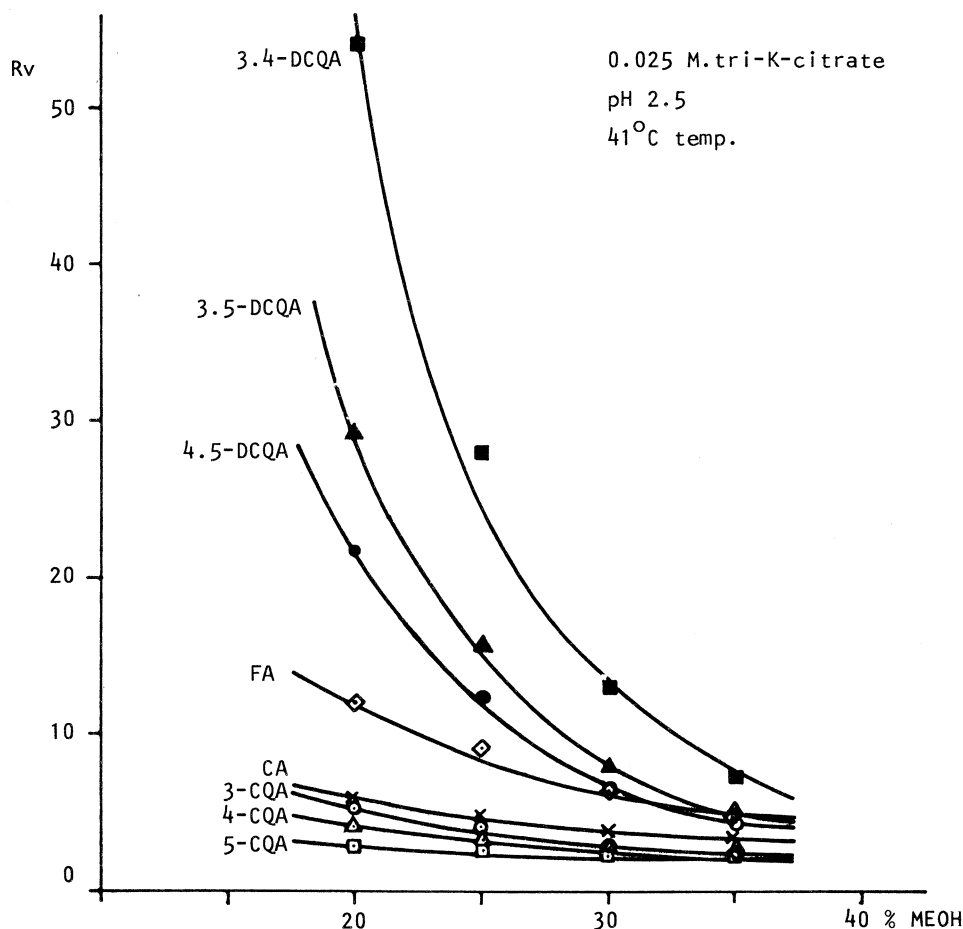

Figure 1: Effect of the methanol content in the eluent upon the retention volume (Rv) of some chlorogenic acids.

The above figure shows that either all chlorogenic acids elute rapidly and with very little resolution or the dicaffeoylquinic acids take a very long time to elute. Therefore gradient elution has been applied. The methanol content of the eluent is linearly increased from 25% at the start to about 50% at the end of the chromatographic run.

The temperature has an effect which is similar to the effect of the methanol content. The function of pH and citrate buffer are merely to stabilise the system.

The complete set of applied chromatographic conditions is summarized below:

Eluent A: 75% water (0.025 M potassium citrate, pH 2.5)

25% methanol

Eluent B: 100% methanol

The amount of B in A + B is over 30 minutes increased from 0 to 30%.

Flowrate \approx 1 ml/min, temperature = 40°C, injection volume = 10 μ l, wavelength of detection = 325 nm.

A chromatogram of a green Ivory Coast Robusta coffee is shown in figure 2.

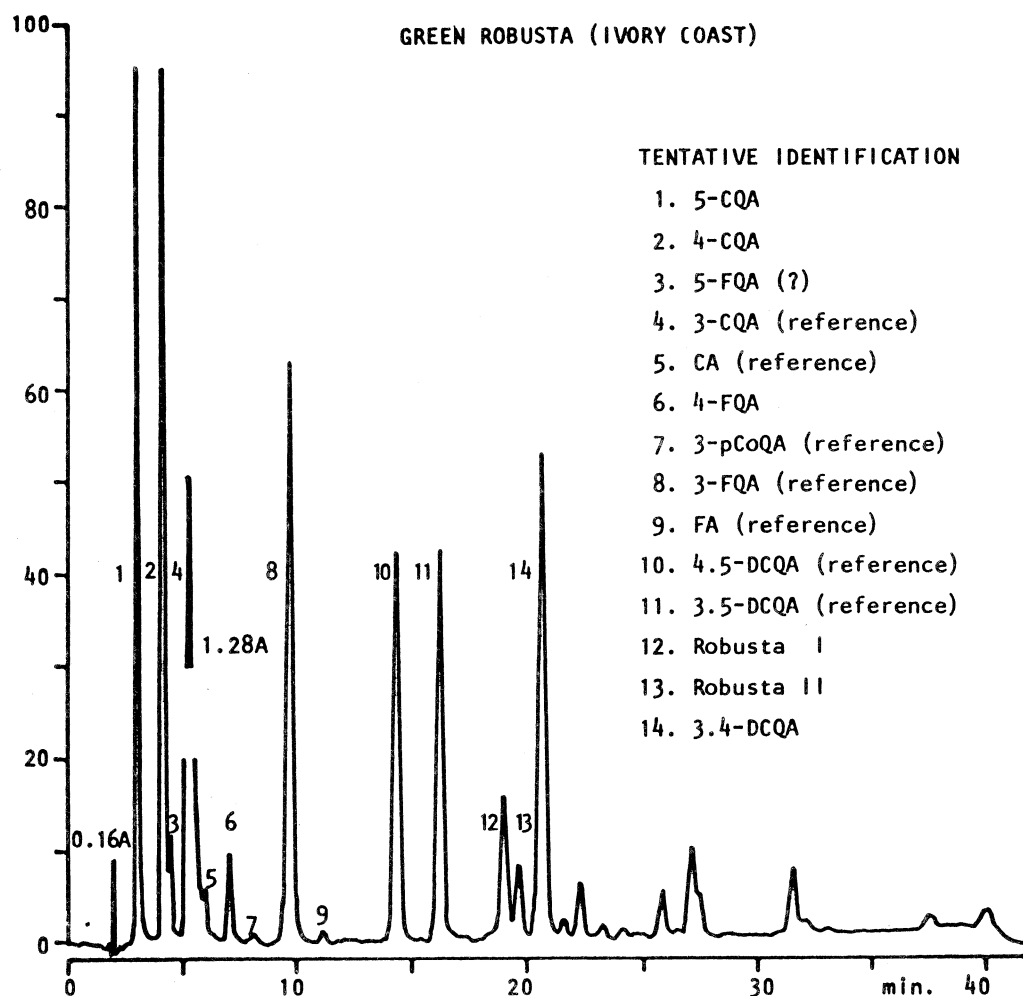

Figure 2: Chromatogram of the chlorogenic acids of a green Ivory Coast Robusta coffee (for conditions see text).

A tentative identification of the peaks in the chromatogram of figure 2 was done by a combination of methods.

- All peaks have acidic properties as they are all retained by an anionexchanger. (Dowex 1x4 eluted with demiwater + 25% methanol.)
- Some of the peaks were identified by comparing elutionvolumes with reference samples (as indicated in figure 2).
- The peaks number 6, 8, 10, 11 and 14 were collected, hydrolysed (1 h. at 100°C under N₂ at 1N.HCL, neutralisation with 2N NaOH) and reinjected. The obtained products of hydrolysis indicate the identities shown in figure 2.
- Based upon differences in the rates of isomerisation from 3-CQA (0.1 M acetate buffer pH 5 at 96°C for several hours), peak number 2 is presumed to be 4-CQA and peaknumber 1 to be 5-CQA.
- The peaknumber 12, indicated as Robusta I, yielded at hydrolysis a mixture with small amounts of caffeic acid, ferulic acid and the monocaffeoyl- and monoferoylquinic acids. Unfortunately the amounts of hydrolysis products constituted a too low recovery, which did not allow conclusions about the identity of peak 12 to be drawn.

A chromatogram of a roasted coffee is shown in figure 3.

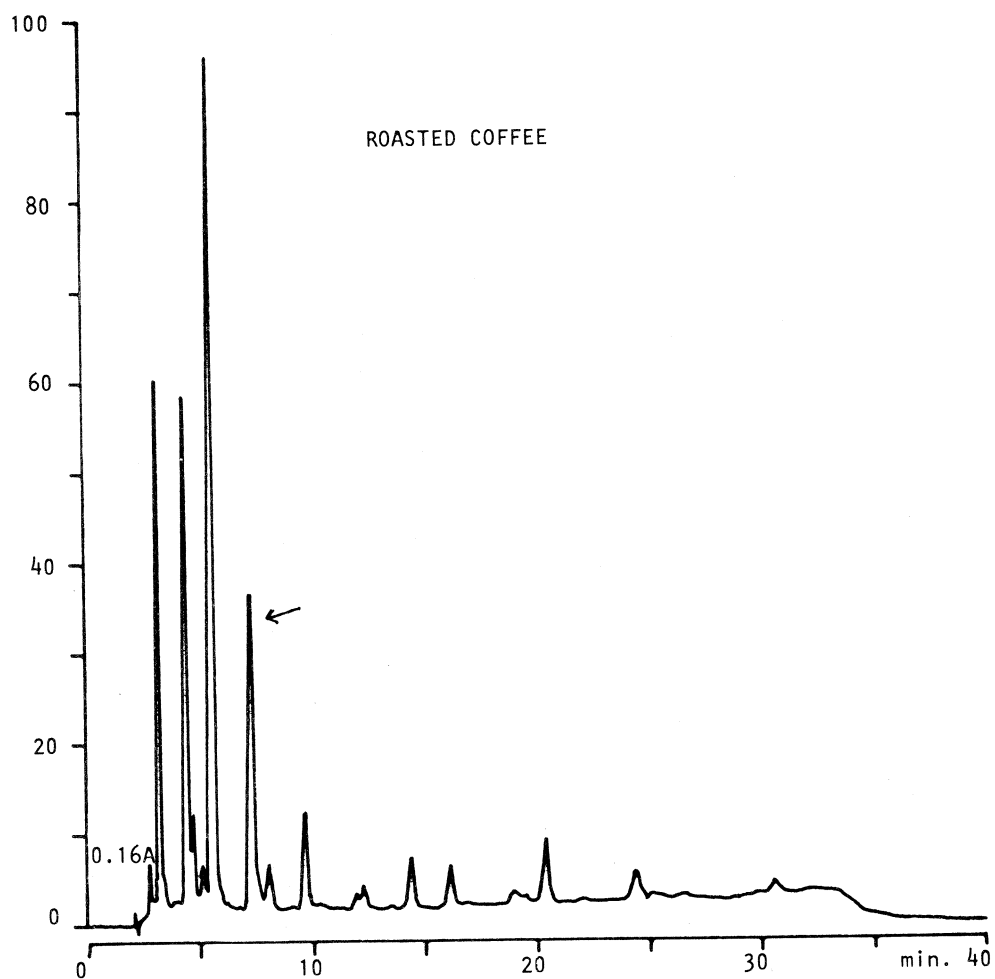

Figure 3: Chromatogram of the chlorogenic acids of a roasted coffee blend.

Except for the peak at the position of 4-FQA most other peaks are considerably smaller than in green coffee. This peak at the 4-FQA position showed, after collecting and rechromatography with an eluent which contained acetonitril instead of methanol, to contain besides 4-FQA still another component. This second component has not yet been identified.

D. Results and Discussions

Quantification of the chromatograms was done by calibration to caffeic acid respectively ferulic acid. In table 1 are shown the results for three types of raw coffee: Robusta and Arabusta both from the Ivory Coast and Arabica from Salvador.

Table 1: Chlorogenic acids in Green Coffee (g/kg d.m.)

	ROBUSTA (Ivory Coast)	ARABUSTA	ARABICA (Salvador)
3-CQA	50.0	47.5	40.7
4-CQA	9.1	8.2	6.6
5-CQA	6.6	5.6	4.5
Subtotal	65.7	61.3	51.8
CA	0.1	<0.1	<0.1
3-FQA	9.8	6.6	3.1
4-FQA	1.3	1.0	0.4
5-FQA	0.7	0.4	0.1
Subtotal	11.8	8.0	3.6
FA	<0.1	<0.1	<0.1
4.5-DCQA	5.9	4.0	2.4
3.5-DCQA	6.0	3.9	3.8
3.4-DCQA	7.9	5.2	3.5
Subtotal	19.8	13.1	9.7
*Robusta I	2.0	0.9	0.1
*Robusta II	1.0	0.5	0.1

*Quantified as if FDCQA.

In all three raw coffees 3-CQA is by far the major component of the group of chlorogenic acids. The Robusta coffee contains considerably more feroylquinic acids and dicaffeoylquinic acids than the Arabica. The Arabusta is in an inbetween position. Even more striking is the difference for the peaks called Robusta I and II, which are almost absent in the Salvador coffee.

The effects of steaming and decaffeination upon the chlorogenic acids of another Ivory Coast Robusta coffee is shown in table 2.

Table 2: Chlorogenic acids in steamed and decaffeinated raw coffee (g/kg d.m.)

	RAW	DECAFFEINATED (D.C.M.)	STEAMED (2 hours at atm. pressure)
3-CQA	44.2	26.5	33.5
4-CQA	8.9	14.3	11.0
5-CQA	6.1	14.0	9.7
Subtotal	59.2	54.8	54.2
CA	0.3	0.2	0.2
3-FQA	9.5	6.0	7.6
4-FQA	1.4	2.8	2.0
5-FQA	0.8	2.0	1.3
Subtotal	11.7	10.8	10.9
FA	0.1	<0.1	<0.1
4.5 DCQA	4.9	4.8	4.7
3.5-DCQA	4.5	3.6	3.9
3.4-DCQA	6.6	5.7	6.3
Subtotal	16.0	14.1	14.9
*Robusta I	1.7	1.5	1.7
*Robusta II	1.0	1.0	1.0

*Quantified as if FDCQA.

Decaffeination and steaming have within the group of chlorogenic acids mainly two effects: First, the total amount of moncaffeoylquinic acids is slightly reduced, without an increase of the free caffeic acid. This might be due to caffeoylic decarboxylation (11, 12). Second, within the group of moncaffeoylquinic acids the 3-isomer is clearly reduced and the 4- and 5-isomer are increased. This effect might be explained by isomerisation of the 3-CQA and perhaps by partial hydrolysis of dicaffeoylquinic acids (1). The same effects are observed with the feroylquinic acids. An example of the chlorogenic acids before and after roasting is given in table 3.

Table 3: Chlorogenic acids in a green and roasted Columbia coffee (g/kg d.m.)

	GREEN	ROASTED
3-CQA	34.4	10.1
4-CQA	5.1	4.8
5-CQA	3.3	4.0
Subtotal	42.8	18.9
CA	<0.1	<0.1
3-FQA	2.7	1.1*
4-FQA	0.4	3.4
5-FQA	0.2	0.5
Subtotal	3.3	
FA	<0.1	<0.1
4.5 DCQA	1.9	0.8
3.5 DCQA	3.3	0.6
3.4 DCQA	3.9	1.1
Subtotal	9.1	2.5
** Robusta I	<0.1	<0.1
** Robusta II	0.1	<0.1

* Quantified as if 4-FQA

** Quantified as if FDCQA

The total amount of chlorogenic acids is drastically reduced during roasting. For the individual components the picture is somewhat different. The reduction of total chlorogenic acids is mainly due to 3-CQA, 3-FQA and the DCQA's. The contents of 4- and 5-CQA appear not to change very much. Compared to the effects of roasting upon the chlorogenic acids the effects of decaffeination and steaming seem to be relatively small.

References

1. U. Kröplein, Thesis, Hamburg, 1963.
2. J.T. Kung e.a. 3rd ASIC, Triest, p 223 (1967).
3. K. Rubach, Thesis, Berlin, 1969.
4. M.N. Clifford e.a., 8th ASIC, Abidjan, p. 103 (1977).
- Food Chem. 4 (1) 63 (1979).
5. W.A. Court, J. Chrom. 130 2877 (1977).
6. D.I. Rees e.a., 8th ASIC, Abidjan, p. 79 (1977).
7. J.A. Krause e.a., J. Chrom., 176 565 (1979).
8. W.M. Walter e.a., J. Agric. Fd. Chem. 27 (5) 938 (1979).
9. M. Haug e.a., Dtsch. Lebensm. Rundsch. 75 (9) 274 (1979).
10. L. Nagels e.a., J. Chrom., 187 181 (1980).
11. P. Windeman, Thesis, Bern, 1974.
12. W. Rahn, Thesis Hamburg, 1979.
- e.a. Z. Lebensm. Unters. Forsch. 169 346 (1979).

ZUR BESTIMMUNG DER EXTRAKTIONS-AUSBEUTE VON KAFFEE-EXTRAKT

Prof. Dr H. G. MAIER
Institut für Lebensmittelchemie
der TU Braunschweig
D-3300 Braunschweig

Nach der EG-Richtlinie vom 27.6.1977 wird Kaffee-Extrakt aus einer Menge ungebrannten Kaffees gewonnen, die zum Zeitpunkt der Herstellung mindestens 2,3 kg je Kilogramm des fertigen Erzeugnisses beträgt. Dies entspricht bei mittlerer Röstung einer Extraktionsausbeute von etwa 50 %, bezogen auf den Röstkaffee. Ein exaktes Analyseverfahren zur Nachprüfung dieser Relation ist nicht bekannt.

Ich möchte im folgenden keine Lösung des gesamten Problems beschreiben, sondern unsere Untersuchungen über 2 Teilprobleme kurz zusammenfassen. Das erste Problem lautet: ist es möglich, ohne Kenntnis des Roh- oder Röstkaffees die Extraktionsausbeute eines Kaffee-Extraktes, bezogen auf den Röstkaffee, zu ermitteln. Das zweite Problem lautet: ist es möglich, die Extraktionsausbeute eines Kaffee-Extrakts zu ermitteln, wenn der zur Extraktion verwendete Röstkaffee ebenfalls analysiert werden kann.

Zur Bearbeitung des ersten Problems standen uns 4 Serien von je 4 Extrakten unterschiedlicher Extraktionsausbeute zur Verfügung. Bei den zugrundeliegenden Röstkaffees handelte es sich um einen Angola Robusta-Kaffee mittleren Röstgrades und um 3 Columbia Arabica-Kaffees niederen, mittleren und hohen Röstgrades.

Die bisher von mehreren Autoren, so von C l a r k e u. W a l k e r (1), H i e k e (2), J a k o b e r u. S t a u b (3) sowie W u r z i g e r (4)

zur Ermittlung der Extraktionsausbeute angewandten Analyseverfahren sind die Asche oder Sulfatasche sowie der Kaliumgehalt. Wir bestimmten diese daher in unseren Extrakten (Abbildung 1, dargestellt sind die Werte für alle 16 Extrakte). Asche und Sulfatasche zeigten auf den ersten Blick eine negative lineare Korrelation zur Extraktionsausbeute. Die Kaliumgehalte (Abbildung 2) verhielten sich ähnlich. Die Korrelation war etwas besser. Noch weiter verbessern ließen sich die Korrelationen, wenn man, wie das theoretisch zu erwarten wäre, keine lineare Abhängigkeit zugrunde legt, sondern eine hyperbolische (Abbildung 3. Dargestellt ist dies am Beispiel der Asche). Aber auch jetzt bestehen, vor allem im Bereich niedrigerer Extraktionsausbeuten, noch starke Abweichungen zu einer theoretischen Regressionskurve. Diese Abweichungen zeigten sich noch deutlicher, als wir 11 weitere Extrakte bekannter Extraktionsausbeute hinzunahmen. Jetzt zeigten sich maximale Abweichungen von rund $\pm 10\%$ Extraktionsausbeute absolut, selbst wenn wir eine neue Regressionskurve für die 27 Extrakte zugrundelegten. Der Hauptgrund hierfür dürfte die biologische Schwankungsbreite im Kalium- und Aschegehalt der einzelnen Rohkaffeesorten und -provenienzen sein. Dies gilt auch für andere Mineralstoffe, von denen wir Natrium, Magnesium und Calcium untersuchten. Diese sowie der Phosphor- und der Stickstoffgehalt korrelierten wesentlich schlechter mit der Extraktionsausbeute als der Kaliumgehalt.

Auf der Suche nach anderen Bestandteilen, die besser korrelieren, untersuchten wir z.B. den Gesamtgehalt an hochmolekularen Stoffen in Form der Trockenmasse des Dialyserückstandes (Abbildung 4). Die Korrelationskoeffizienten lagen bei 0,95, aber die Werte waren sehr von der Art und vom Zustand der Dialysemembran abhängig. Weitere mögliche Bestimmungen wären die elektrische Leitfähigkeit (Abbildung 5. Sie verhält sich ähnlich wie der Aschegehalt), der Gehalt an freier Mannose (Abbildung 6, diese nimmt mit der Extraktionsausbeute zu) und derjenige an Stoffen, die beim Stehenlassen in kaltem Wasser von alleine ausfallen (Abbildung 7. A bezeichnet die Serie mit Columbia Arabica, mittelstark geröstet, H mit Columbia Arabica, schwach geröstet, D mit Columbia Arabica, stark geröstet und R mit Angola Robusta, mittelstark geröstet). Schlechter geeignet sind die Kupferfällung nach Thaler (Abbildung 8), die direkt reduzierenden Zucker (Abbildung 9, die Werte für schwach gerösteten Arabica fallen heraus), die gesamten reduzierenden Zucker (Abbildung 10, hierauf wurden nur 2 Serien analysiert), der Coffeingehalt (Abbildung 11) und schließlich der Chlorogensäuregehalt (Abbildung 12), der bekanntlich bei schwach gerösteten Bohnen (H) wesentlich größer ist als bei stärker gerösteten.

Noch weniger geeignet waren die Bestimmungen von freien Zuckern außer

Mannose, von Hydroxymethylfurfural und von mit Säure fällbaren Melanoidinen. Keine der geprüften Methoden war besser als die Kalium- oder Sulfataschebestimmung. Da wir auch durch einfache mathematische Kombination der besten Bestimmungsmethoden keine Steigerung der Genauigkeit erzielen konnten, glaube ich, daß zur Zeit die Ermittlung der Extraktionsausbeute am besten durch Bestimmung des Kalium- oder Sulfataschegehalts erfolgen kann, mit Fehlern von etwa $\pm 10\%$ absolut.

Leichter sollte die Lösung des zweiten Problems sein. Nimmt man an, daß bei der Extraktion des Röstkaffees das Kalium restlos extrahiert wird, so müßte sich die Extraktionsausbeute aus den Kaliumgehalten von Röstkaffee und Extrakt sehr genau ermitteln lassen. Die Reproduzierbarkeit der Kaliumbestimmung ist gut (Tabelle 1), insbesondere die der gravimetrischen. Leider wird aber das Kalium bei der Extraktion nicht vollständig extrahiert (Tabelle 2). Bei 2 Serien von Extrakten (Angola Robusta und Columbia Arabica, je mittelstark geröstet) fanden wir Restgehalte von 1-11 % des gesamten Kaliums im Extraktionsrückstand, und zwar insbesondere bei relativ schwach extrahierten Produkten. Auch C l a r k e und W a l k e r fanden Kalium in Extraktionsrückständen, allerdings weniger, nämlich im Mittel 0,02 % in der Trockensubstanz. Bei anderer Herstellung der Extrakte fanden auch wir zum Teil geringere Werte im Extraktionsrückstand, so nach der etwa 4 h langen Extraktion von Columbia Arabica-Röstkaffee in einer industriellen Versuchsapparatur mit Wasser von 110°C noch durchschnittlich 670 mg/kg, das entspricht etwa 0,07 % i. Tr. oder 3 % des gesamten Kaliums. Wurde jetzt noch mit Wasser von 180°C etwa 4 h extrahiert, so verblieben nur noch 49-200 mg/kg oder 0,2-1,1 % des gesamten Kaliums.

Bei einem Laborationsversuch wurde eine Röstkaffeemischung des Handels 24 h lang im Soxhlet-Extraktionsapparat mit Wasser extrahiert. Hierbei verblieben nur noch 15 mg/kg im Extraktionsrückstand. Dies deutet darauf hin, daß die Dauer der Extraktion eine wichtige Rolle spielt und vielleicht weniger die Temperatur. In der Tat ließ sich von dem in der Tabelle 2 aufgeführten Extraktionsrückstand mit der größten Kaliumkonzentration bei weitem die Hauptmenge schon bei Zimmertemperatur durch 24 stündiges Extrahieren mit Wasser entfernen. Die dann noch gebundenen kleinen Mengen lassen sich etwa zur Hälfte entfernen, wenn dem Extraktionswasser Natriumchlorid oder Magnesiumchlorid hinzugefügt wird. Dies deutet darauf hin, daß auch ein Ionenaustausch stattfinden kann. Da das Extraktionswasser bei der industriellen Herstellung von Kaffee-Extrakten Ionen in unterschiedlicher Konzentration enthalten kann, ist hierdurch eine weitere Unsicherheit bei der Ermittlung der Extraktionsausbeute über den Kaliumgehalt gegeben.

Obwohl wir weitere genauere Untersuchungen für notwendig erachten, möchte ich doch vermuten, daß die Fehler bei der Ermittlung der Extraktionsausbeute, wenn Röstkaffee und Kaffee-Extrakt vorliegen, bis etwa 5 % absolut betragen können. Bei 8 Extrakten aus 2 Serien fanden wir durchschnittlich 2,1 % zu hohe Extraktionsausbeuten, mit Extremwerten von + 0,5% und 4,7 %. Obwohl wir auf grund der Laborversuche und der von C l a r k e und W a l k e r angegebenen Werte vermuten, daß normalerweise geringere Fehler entstehen, ist doch anzunehmen, daß bei bestimmten Herstellungsverfahren von Kaffee-Extrakt, insbesondere bei schneller Extraktion, solche großen Fehler bei der Berechnung der Extraktionsausbeute entstehen können.

Wir halten es deshalb nicht für sinnvoll, die Ermittlung der Extraktionsausbeute nur auf einen Bestandteil wie etwa das Kalium zu stützen. Vielleicht könnte die mathematische Kombination der Werte für mehrere Bestandteile oder die Einführung von Grenzwerten eines Tages weiter führen.

Literatur

1. Clarke, R.L. u. L.J. Walker, J. Sci. Food Agric. 25, 1389 (1975)
2. Hieke, E., Vortrag GDCh-Arbeitsgruppe Lebensmittelchemie und gerichtliche Chemie, Arbeitskreis Südwestdeutschland. 11.4.1969 Karlsruhe
3. Jakober, P. u. M. Staub, Mitt. Gebiete Lebensm.-Untersuch. Hyg. 54, 26 (1963)
4. Wurziger, J., Kaffee u. Tee Markt 16 (17), 6 (1966)

Dank

Die Arbeiten wurden vom Bundesministerium für Jugend, Familie und Gesundheit finanziell unterstützt. Ausgeführt wurden sie von Frau Dr. Ollroge, Frau Dr. Pohl, geb. Wewetzer und Frau Freda-Carola Thies.

Tabelle 1. Vergleich der Reproduzierbarkeit der Methoden zur Ermittlung der Extraktionsausbeute.

Variationskoeffizienten (%), ber. aus 16 Doppelbestimmungen

K (gravimetrisch)	0,6
Leitfähigkeit	0,6
K (FES), aus Sulfatasche	0,8
Sulfatasche	0,9
Dialyse-Rückstand	1,5
Asche	1,6
K (FES), aus Asche	2,0

Tabelle 2. Restgehalte an Kalium in den Extraktionsrückständen der Serien 1 und 3.

Extrakt Nr.	Extraktions- ausbeute (%)	Kalium	
		% i. Tr.	% des gesamten K
11	39,5	0,36	10,8
12	45,2	0,04	1,1
13	48,7	0,10	2,7
14	58,0	0,17	3,5
31	38,0	0,21	6,6
32	39,8	0,08	2,4
33	43,6	0,11	3,1
34	53,2	0,08	1,8



Abbildung 1. Abhängigkeit der Asche und Sulfatasche von der Extraktionsausbeute



Abbildung 2. Abhängigkeit der Kaliumgehalte von der Extraktionsausbeute

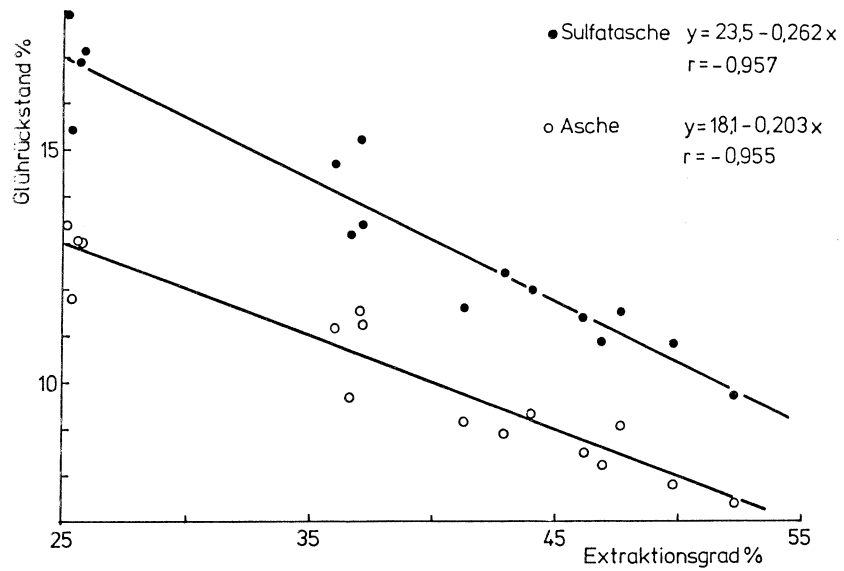

Abbildung 3. Abhängigkeit der Asche von der Extraktionsausbeute

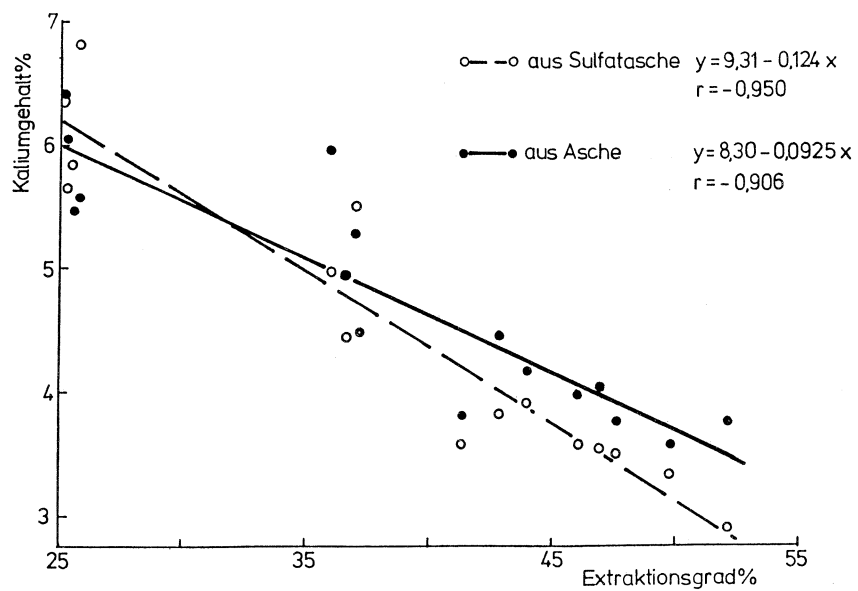

Abbildung 4. Abhängigkeit der Dialyserückstände von der Extraktionsausbeute. I-III = verschiedene Dialysesläuche

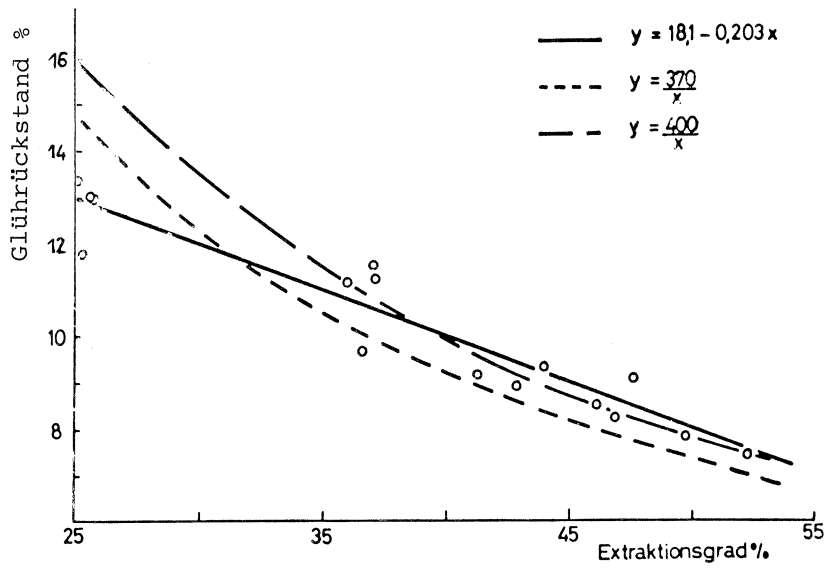

Abbildung 5. Abhängigkeit der elektrischen Leitfähigkeit von der Extraktionsausbeute

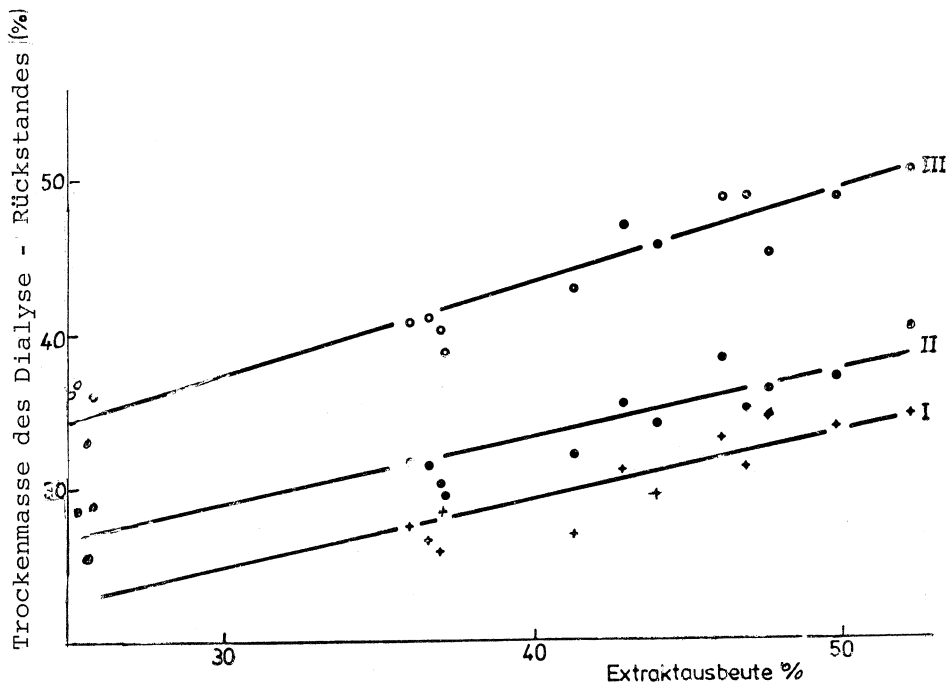

Abbildung 6. Abhängigkeit der Gehalte an freier Mannose von der Extraktionsausbeute (Ollroge 1980)

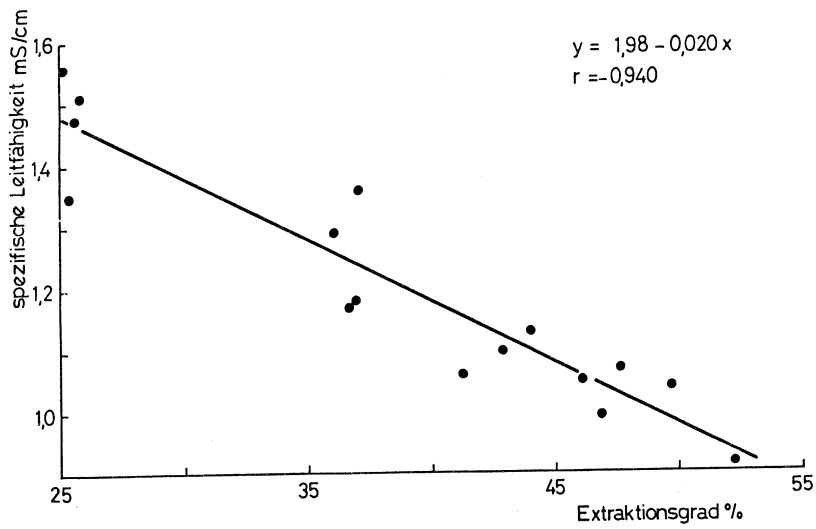

Abbildung 7. Abhängigkeit der Gehalte an Stoffen, die beim Stehenlassen in kaltem Wasser von alleine ausfallen, von der Extraktionsausbeute

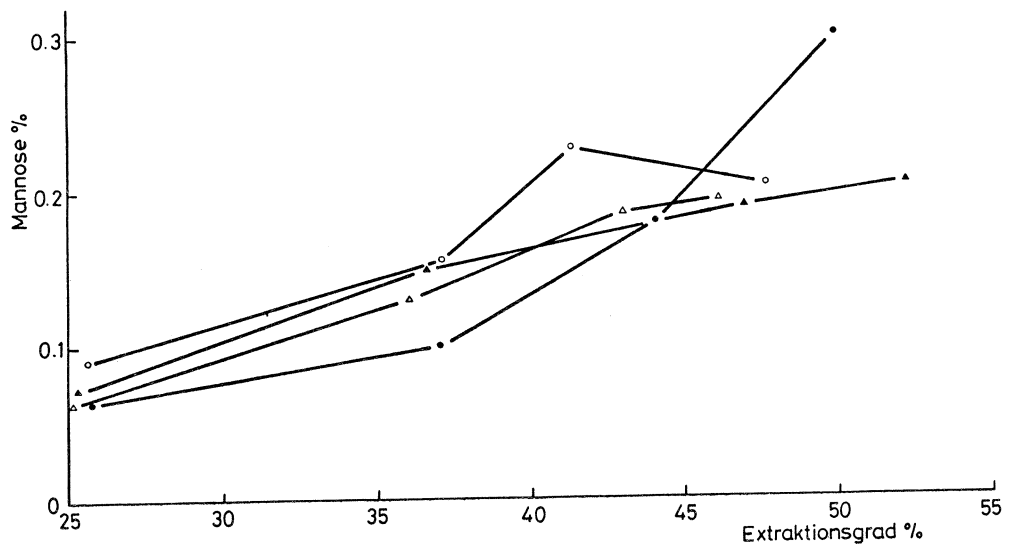

Abbildung 8. Abhängigkeit der Gehalte an Stoffen, die nach Thaler mit alkalischer Kupferlösung fällbar sind, von der Extraktionsausbeute

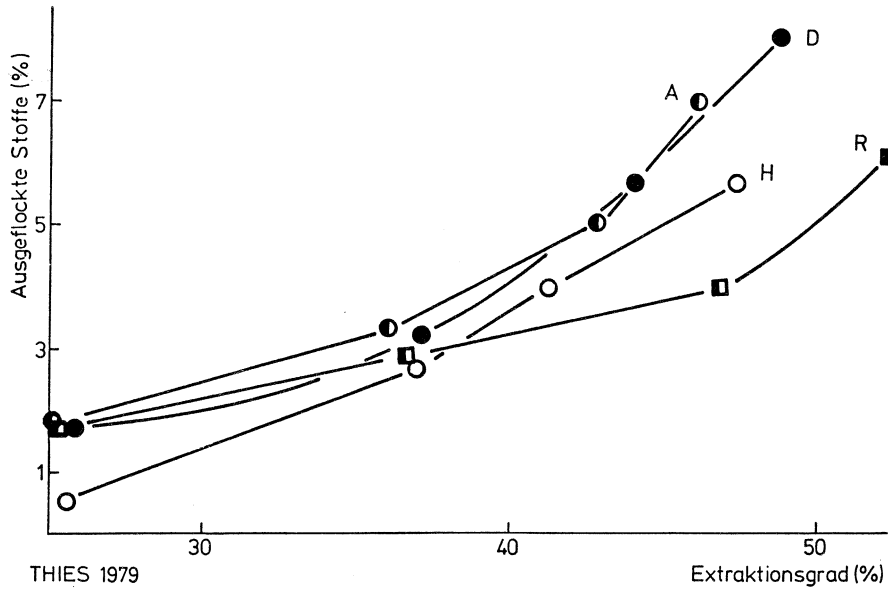

Abbildung 9. Abhängigkeit der Gehalte an direkt reduzierenden Zuckern von der Extraktionsausbeute

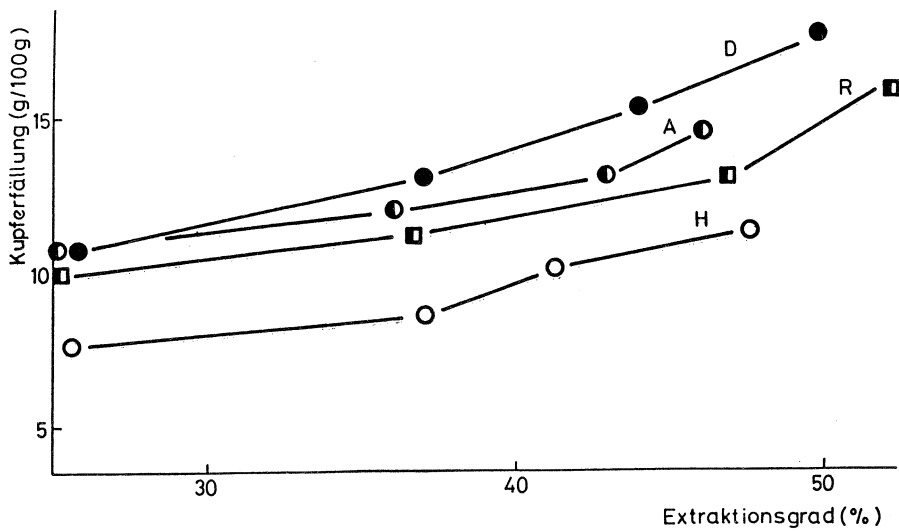

Abbildung 10. Abhängigkeit der gesamten reduzierenden Zucker von der Extraktionsausbeute

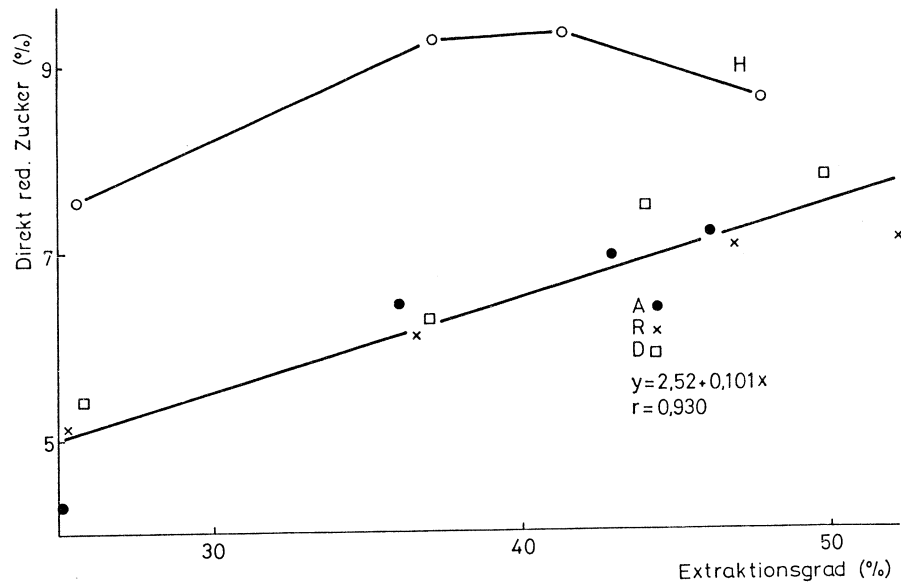

Abbildung 11. Abhängigkeit der Gehalte an Coffein von der Extraktionsausbeute

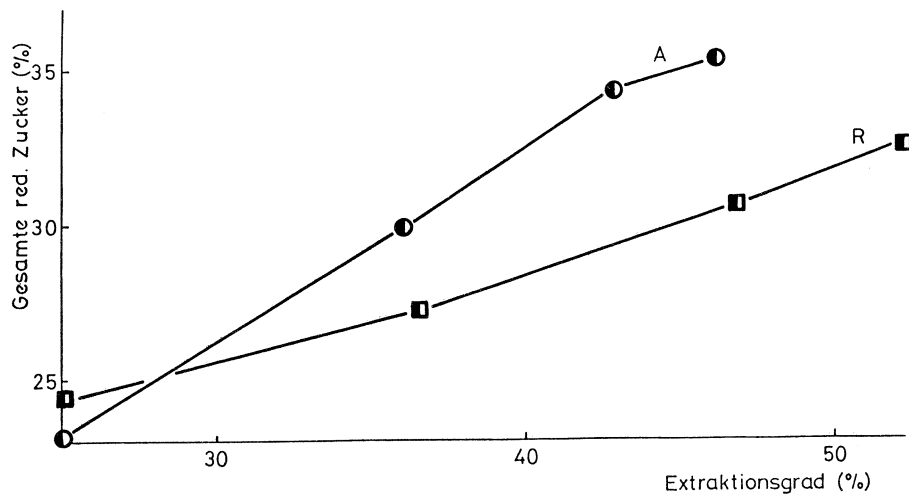

Abbildung 12. Abhängigkeit der Gehalte an Chlorogensäuren von der Extraktionsausbeute

INVESTIGATIONS OF CONTAMINANTS IN COFFEE

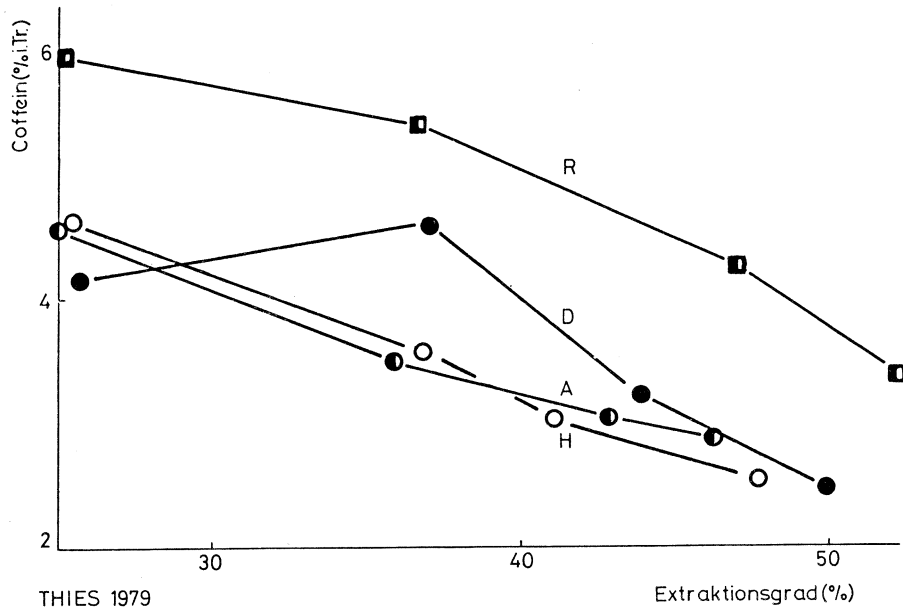
C. P. LEVI

General Foods Technical Center

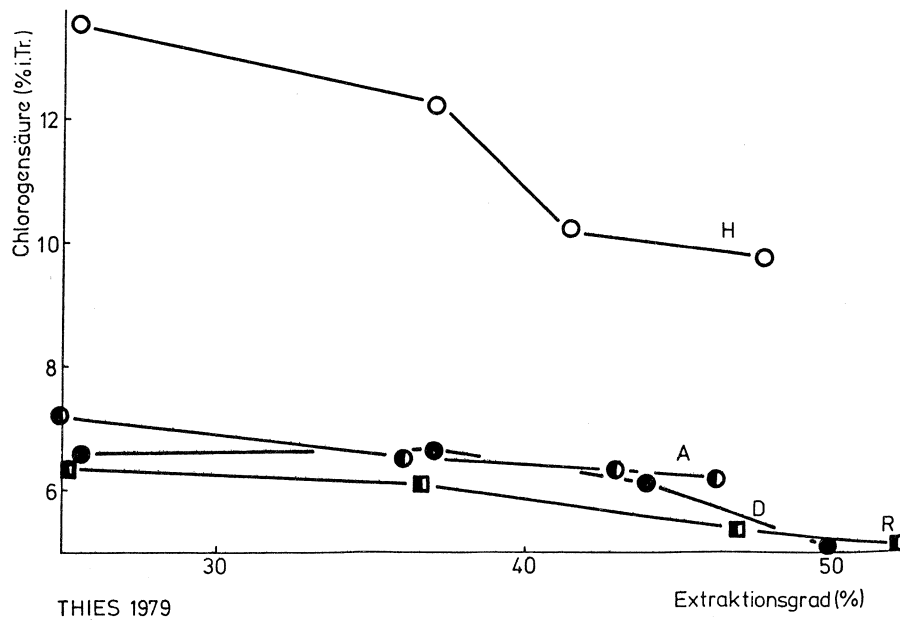
Tarrytown, New York

I. BENZO(a)PYRENE IN COFFEE

The importance of polycyclic aromatic hydrocarbons (PAH) in the environment of man has been recognized since the early 1930's. In 1932, benzo(a)pyrene (BaP) was identified among the PAH isolated from coal-tar by Cook (1), who demonstrated that that product was active in producing cancer. Since that time a vast body of literature has accumulated, dealing with both the presence of PAH in the environment and with the development of sensitive and specific methods of analysis. These compounds have been shown to occur in soot and smoke condensates, engine exhausts, tobacco smoke and tar, as well as in food products such as smoked cheese, sausages, smoked fish and meats, vegetable oils, etc. Although other members of this family of compounds may be of comparable toxicological importance, BaP has been used as an indicator of the presence of other PAH's. In this report, reference will be made mainly to that compound.

Benzo(a)pyrene Findings and Analytical Methods: Literature Review

In 1958, BaP was found in soot deposits in the exhaust stacks of coffee processing plants by Kuratsune (2). The same author reported later that levels of 4 mcg/kg of the compound could be found in roasted coffee, along with as many as ten different PAH (3). Both Kuratsune and later Chassevent (4) believed that the levels of PAH would be related to the degree of roasting, and that coffee roasted at 250°C would contain only minimal amounts of BaP. Pertoldi-Marletta (5) reported on the development of an analytical procedure to examine coffee and coffee smoke. Although no actual levels were reported in that publication, it was noted that various PAH could be detected together with BaP in both dark-roasted coffee and in the fumes collected from the roasting operation. Calzolari (6) was not able to detect PAH in coffees roasted at 180°C, but did find them in coffee roasted at 210 and 240°C. The levels of BaP found in coffee roasted at 240°C were of the order of 5 mcg/kg in coffee and of 1 mcg/kg in the fumes. Grimmer (7) found less than 0.4 mcg/kg BaP in roasted coffee, but concluded that the degree of roasting would not change those levels. Fritz (8) noted that the greater concentration of BaP and other PAH occurs in the coffee membrane and tar. This author compared the amounts of BaP found in normally roasted coffee beans (0.3-0.5 mcg/kg) with those detected in coffee substitutes, such as raw malt and barley (0.4-0.7 mcg/kg), malt roasted in a coal-fired roaster (15.8 mcg/kg) and malt coffee substitute roasted in a gas-fired roaster (0.9-1.0 mcg/kg). These findings indi-

cated that the levels of PAH found in grains used for the manufacture of coffee substitutes appeared to be somewhat higher than those found in coffee itself. Maier (9) investigated the levels of PAH in aqueous extracts of commercial roasted chicory, barley, rye, and sugar beet, finding levels ranging from 0.04 to 0.4 mcg/kg BaP. Also found in those extracts were 1,12-benzoperylene and fluoranthrene. Studying aqueous extracts of coffee and coffee substitutes, Fritz (10) concluded that the major portion of the PAH remained in the grounds of infusions prepared with coffee substitutes (0.1-0.3 mcg/kg coffee substitute extract or powder), while the reverse occurred in the case of coffee infusions (0.2-0.3 mcg/kg BaP). This difference was attributed to a possible solubility enhancement caused by caffeine. D'Arrigo (11) compared the amounts of BaP in green coffee with those of coffee roasted at 160 and 180°C. Finding levels ranging from 0.6 to 2.3 in three types of green coffee, and 1.1-1.9 mcg/kg in roasted coffee, the author was of the opinion that part of the compound was lost during the roasting operation. Bracco (12) developed a procedure for the analysis of PAH in coffee oils finding 0.01 mcg/kg BaP in coffee oil extracted from green or roasted coffee beans (equivalent to less than 0.01 mcg/kg in roasted and green coffee) while none was found in oil from instant coffee. These amounts are lower than those published previously by other investigators. The author also compared the levels of BaP and of other PAH found in coffee oil with those reported for other vegetable oils, such as soybean and groundnut oil, noting that the higher amounts formed in vegetable oils may be attributed to the effects of atmospheric pollution and refining processes. Strobel (13) reported finding 0.02 to 0.06 mcg/kg BaP in soluble coffee, 0.003 mcg/kg in coffee brew and 0.5 mcg/kg in coffee oil. Soos (14) investigated the effect of the roasting techniques used in Hungary on PAH levels. Seven varieties of green coffees were found to have an average of 0.4 mcg/kg BaP, with only one variety, Indian Extra, showing a high level of BaP (4.4 mcg/kg). Analyses of blends of these coffees after roasting revealed amounts of 1.1 to 3.1 mcg/kg BaP, the author concluded that roasting appears to increase the level of the compound to levels higher than those reported by other European countries, where the roasting operation is of shorter duration and proceeds at lower temperatures (6-7 min., 180-230°C). The effects of light, regular, and dark roasting (no colors or temperature are given) were also examined, revealing levels of 0.2 to 3.7 mcg/kg BaP in the darker coffees. Coffee brews, prepared using three different methods, were found to contain 0.3-0.4 mcg/kg BaP, which is only 10-20% of the BaP content of the coffees from which the brews were prepared (see above), leading this investigator to conclude that most of the BaP remained in the coffee grounds. However Fritz (15), discussing the formation and accumulation of PAH's during food processing, remarked again that regular roasted coffee contains 0.3-0.5 mcg/kg BaP, most of which is transferred to the brew because of caffeine's effect on the solubility of the compound. Also discussed was the effect of baking and frying of foods, the author noting that there was no apparent accumulation of PAH in oven-baked bread, and that the content of BaP in oils decrease with repeated usage. It was also noted that direct contact with combustion gases increased the concentration of BaP in coffee by a factor of 50. Lintas (16) analyzed smoked, cooked and toasted products, reporting 0.01 and 0.8 mcg/kg BaP respectively, in coffee infusions and coffee powder analyzed using Gas Chromatography and Mass Spectrometry. The author noted that the levels of BaP in foodstuffs found using this method were lower than those reported previously for similar food products. The published findings of BaP in coffee are listed in Table I.

It is not possible to include here a comprehensive review of the many procedures for the analysis of PAH in a variety of environmental samples and food products. Mention will only be made of those that have been applied to coffee and that, in our opinion, show the state-of-the-art at the time in which they were used. An outline of the approach generally used is as follows: 1) extraction with a solvent (i.e., benzene, hexane, cyclohexane), 2) possible saponification of the residue, 3) purification using liquid-liquid partition, and 4) further purification using Florisil or Silica Gel column chromatography and/or thin layer chromatography (TLC) on (acetylated cellulose or silica gel). The compounds are then detected in the purified extract using ultra-violet or fluorescence spectrophotometric techniques.

Illustrating the main differences in the procedures used in the analysis of coffee, Pertoldi-Marletta (5) (6), extracted the coffee with petroleum ether and the saponified residue was then re-extracted into petroleum ether. The latter was purified using an alumina column and thin layer chromatography on acetylated cellulose. The BaP extracted from the chromatospot was then examined using UV and fluorescence spectrophotometry.

D'Arrigo (11) followed very similar steps, but did not include thin layer chromatography clean-up. Bracco (12) developed a method for vegetable oils and applied it to coffee oil. The lipids were extracted in isooctane with phosphoric acid, followed by extraction with dimethylsulfoxide and re-extraction into isooctane. Further clean-up was achieved using a Florisil column and thin layer chromatography on silica gel impregnated with caffeine. Strobel (13) examined coffee oil, instant coffee, and coffee brew using two developments on 40% acetylated paper to separate BaP from other fluorescing compounds. The intensity of the BaP fluorescence was measured directly on the paper. Soos (14) used a separation scheme similar to that of Bracco, but used thin layer chromatography on a mixture of alumina, silica gel, and acetylated cellulose powder.

In recent years High Pressure Liquid Chromatography (HPLC) has been developed to provide an excellent technique for the determination of BaP in various products. As one example of its many applications, Das (16) demonstrated that, by using reverse-phase columns coupled with fluorometric detection using excitation wavelengths below 300 nm, as little as 1 pg BaP could be detected. Samples of particulate emission and recycle water of a coke oven plant, could be analyzed in this manner with minimal clean-up. The application of this technique to foods has been described by Guerrero (18) and Panalaks (19) who observed that the levels of BaP found in various foods using High Pressure Liquid Chromatography were much lower than those published earlier, undoubtedly due to both improved clean-up procedures and the use of detection technique which is more sensitive and specific.

Gas chromatography, with flame ionization or electron-capture detection, has also been used for the analysis of BaP, but there are no published reports of its application to coffee, except for the work of Lintas (16), using GC-MS.

Listed in Tables II and III are levels of BaP reported for grains, vegetable oils and various prepared foods. In Table II, the levels of BaP found in wheat, barley and rye sampled in both industrial and non-industrial areas show the effect of environmental pollution on the levels of PAH in grains. The levels of BaP in coffee oil reported by Bracco (12) are listed in the same table. To illustrate both variations arising from the use of different determinative steps, as well as variations due to the product itself, Table III includes levels of BaP reported by Panalaks (19) and Lintas (16), together with values reported previously for similar products. The amounts reported using techniques such as High Pressure Liquid Chromatography and Gas Chromatography and Mass Spectrometry are lower than those published in the earlier literature. An example of the difficulty in establishing a natural level for a product is perhaps illustrated by the spread of the levels reported for olive oil (0.5 to 3.6 mcg/kg); these apparent discrepancies may reflect variations in natural products, but could very well be also due to differences in methodology.

The method recommended for analyses of PAH in foods by the Commission on Food Additives of IUPAC (20) is that of Howard (21), based on saponification, liquid-liquid partition, column chromatography and thin layer chromatography, followed by ultra-violet spectrophotometry and spectrofluorometry. Also recommended is the method of Grimmer (22) developed for high fats products, where gas chromatography is used to detect the compounds in the purified extracts. It is suggested that the PAH identification should be confirmed using mass spectrometry. Methods for the analysis of BaP are also included in the Official Methods of the Association of Official Analytical Chemists (23).

In summary, the published findings revealed essentially low levels of BaP in coffee, actual concentrations ranged from less than .01 to 5 mcg/kg of roasted coffee. These variations and the sometimes contradictory conclusions expressed by the various authors can be explained by the following considerations: 1) The experiments were conducted with different varieties of coffees, roasted under different conditions. 2) The literature reports reflect efforts to analyze coffee during a period of approximately twenty-one years using different methods of analysis which changed as new techniques became available. 3) The analysis of trace amounts of PAH in a matrix as complex as coffee is particularly difficult because of interfering substances. Only in recent years has it become possible to examine simpler matrices of environmental samples such as air, smoke, and water with a satisfactory degree of confidence.

Analytical Methods Used in Our Laboratory

In the past, we have examined coffees for the presence of BaP using modifications of the methods of Genest (24), Howard (21) (25), and White (26). Using these procedures it was not possible to detect levels of BaP lower than 5 mcg/kg in roasted and ground or soluble coffee. None of the coffees we examined exceeded this level.

More recently, in an effort to achieve lower limits of detection than those obtained previously, several methods of analysis were experimentally evaluated. Finding significant variations between different batches of Florisil and silica gel (as measured by recoveries of BaP), we elected to use liquid-liquid partition for the purification of sample extracts followed by High Pressure Liquid Chromatography with fluorescence detection.

Because a high fluorescent background made direct analysis of roasted and ground coffee difficult, we analyzed extracts of these coffees prepared using the European Decaffeination Association method for Soluble Solids (27). Soluble coffees were analyzed directly.

Materials and Methods

Roasted and Ground Coffee: Add 400 ml water to 20g coffee. Bring to boil while stirring, boil for 5 minutes. Cool, bring back to weight and filter. Use a 200 ml aliquot for analysis. Make alkaline and extract into isooctane; extract into dimethylsulfoxide; extract into benzene; concentrate under nitrogen, and determine by reverse-phase High Pressure Liquid Chromatography. Recoveries of BaP added to coffee extract at levels of 0.12 and 0.24 ng/ml were 84 and 83%, respectively. The estimated limit of detection was 0.02 ng/ml in the extract, corresponding to 0.5 mcg/kg R&G.

Soluble Coffee: Saponify 25g soluble coffee using ethanolic KOH. Extract into cyclohexane using Celite as support, and continue with the balance of the procedure for R&G coffee. Average recoveries of BaP added to soluble coffee at levels of 0.96 and 9.6 mcg/kg were 58 and 68%, respectively. The estimated limit of detection was 0.1 mcg/kg soluble coffee.

Limits of detection were always estimated experimentally, by spiking actual sample extracts with low levels of BaP.

High Pressure Liquid Chromatography Parameters

Instrument: Waters Assoc. or equivalent, equipped with Schoeffel Fluorescence Detector
Excitation: 260 NM
Emission: 389 NM (filter)
Column: Bondapak μ C₁₈ or equivalent or Radial Compression Module (Waters) with reverse-phase column.
Injection Volume: 50 μ l
Eluent = acetonitrile-water (80:20)

Results and Discussion

Thirteen roasted and ground and twenty soluble coffees were examined using the procedures described above. Levels ranging from 0.5 to 3 mcg/kg BaP were found in eight of the roasted and ground coffees and levels ranging from 0.1 to 0.7 mcg/kg were detected in nine of the twenty soluble coffees (Table IV). No BaP was detected in any of the other sixteen samples examined (i.e., below 0.1 mcg/kg). Identification of these apparent levels of BaP was done only by using retention volumes in the High Pressure Liquid Chromatography step. Confirmation of identity by Gas Chromatography and Mass Spectrometry was not attempted and, in fact, would require a significant effort at these levels. Inspection of Table I indicates that the amounts found in coffee are of the same order of magnitude as those reported by other investigators.

In conclusion, the levels of BaP in coffee appear to be low, of the order of 1 to 4 mcg/kg for Roasted and Ground coffee, and less than 1 mcg/kg for soluble coffee. As noted above,

it is difficult (especially at these low levels) to compare results with those published previously. Moreover, the literature provides little data on accuracy and precision for the various methods given, and no inter-laboratory studies have been performed to the best of our knowledge. A sensitive, accurate and precise method applicable to a natural matrix as complex as roasted coffee, is still to be developed.

II. MYCOTOXINS IN COFFEE

Studies concerning mycotoxins in coffee have been presented in a previous meeting of this Association (28). We reported then our results on experimental toxin production, the effect of experimental roasting, the limiting value of moisture for molding of green coffee, analytical methods used for toxin detection, as well as the results of surveys of green coffee for the presence of aflatoxin B₁, ochratoxin A and sterigmatocystin. We have now compiled data of both previously published and unpublished surveys of a greater number of samples for the presence of the three toxins mentioned.

Surveys of Damaged Coffees

Fifty-eight heavily damaged green coffees were collected from 1964 to 1967 and were examined for aflatoxin levels in our laboratories, finding no toxin in any of the samples analyzed, Levi (29). After finding that ochratoxin could be present in moldy coffee, we analyzed two hundred and sixty-seven samples from hand-cleaned lots detecting ochratoxin in nineteen samples. Of these, only one had a relatively high level of toxin (360 mcg/kg), Levi (30). No sterigmatocystin was found in fifteen green coffees, ten of which were non-deliverable damaged coffees, Levi (28) (Table V).

Surveys of Commercial Green Coffees

No aflatoxin was detected in six hundred and forty commercial green coffee samples analyzed by a U.S. coffee processor (31). These samples were collected over a period of thirteen years and were received from thirteen countries. A second U.S. coffee processor advised us that no aflatoxin was found in twenty-two commercial green coffees (32). A European coffee processor sponsored the analyses of five hundred and two samples of green coffee entering the Port of Trieste (33). No aflatoxin, ochratoxin or sterigmatocystin were found in any of these samples. In that same study, one sample of heavily moldy coffee was found to have a high level of sterigmatocystin (12 mg/kg). This finding coincides with a report by Purchase (34), of the natural occurrence of that toxin in one sample of mold-damaged beans. It agrees as well with our experience with the experimental production of this toxin in green coffee, which indicated that toxin production is slow with respect to actual mold growth, and will probably only be found after heavy mold growth in non-deliverable lots of coffee. Sixty-eight green coffees were analyzed for ochratoxin levels in our laboratories. Three of these samples were found to have detectible levels of toxin (2 at ca. 20, 1 at ca. 80 mcg/kg), Levi (30). Finally, as part of a two year survey of imported green coffee beans, the Mycotoxin Analytical Laboratory, US Department of Agriculture, analyzed two hundred and one samples for the three mycotoxins. Low levels of aflatoxin (3 and 12 mcg/kg) were detected in two samples and ochratoxin was found in another two samples (24 and 96 mcg/kg) (35) in the same study. The results of the surveys of commercial green coffees are summarized in Table VI.

In summary, although low levels of these three mycotoxins can occasionally be detected in green coffee, this occurs infrequently. Furthermore, all three mycotoxins are susceptible to major degradation upon roasting. Therefore, it can be concluded that the probability of finding these mycotoxins in the coffee beverage is very low.

The author wishes to thank IllyCaffe, Procter and Gamble, Nestle's and the Mycotoxin Analytical Laboratory, FDA, USA, for making the results of their investigations available to us.

Table I

Literature Reports of BaP in Coffee

<u>Roasted & Ground</u>	<u>Green</u>	<u>Instant</u>	<u>Brew</u>	<u>Coffee Oil</u>	<u>Comments</u>	<u>Reference</u>
3-4						Kuratsune (1958)
4					increases with deg. roast	Kuratsune (1960)
1.2					increases with deg. roast	Chassevent (1963)
-- (1)						Pertoldi-Marletta (1965)
5					roasting 210-240°C	Calzolari (1967)
less 0.4					degree of roasting has no effect	Grimmer (1966)
0.3-0.5			0.2-0.3			Fritz (1968)
1.1-1.9	0.6-2.3				transfers to brew	Fritz (1969)
less 0.01	less 0.1	ND (2)		0.01 (3)	lost in roasting	D'Arrigo (1971)
		0.02-0.06	0.003	0.5	levels much lower than other products	Bracco (1973)
1.1-3.1	0.4		0.3-0.4		does not transfer to brew	Strobel (1973)
0.3-0.5					transfers to brew due to caffeine effect	Soos (1974)
		0.08	0.01		0.8 refers to "powder"	Fritz (1975)
						Lintas (1979)

(1) - BaP detected, level not mentioned in text.

(2) - ND - none detected.

(3) - Roasted or green coffee oil.

Table II

Benzo(a)Pyrene in Various Grains and Vegetable Oils

<u>Grains</u>	BaP <u>mcg/kg</u>	<u>Comments</u>	<u>Reference</u>	
Wheat	0.47	Industrial zone	Bolling	(1964)
	0.13	Non-industrial zone	Bolling	(1964)
Rye	0.70	Industrial zone	Bolling	(1964)
	0.16	Non-industrial zone	Bolling	(1964)
Barley	1.21	Industrial zone	Bolling	(1964)
	0.11	Non-industrial zone	Bolling	(1964)
<u>Vegetable Oils</u>				
Soybean	1.4		Howard	(1966)
Olive	0.5		Howard	(1966)
Cottonseed	0.4		Howard	(1966)
Corn	0.7		Howard	(1966)
Peanut	0.6		Howard	(1966)
Coffee Oil	0.1	roasted	Bracco	(1973)
	0.1	green	Bracco	(1973)

Bracco, V. J., Appl. Bact. 36 (4), 619, 1973

Table III

Benzo(a)Pyrene of Various Prepared Food Products

<u>Product</u>	BaP <u>mcg/kg</u>	<u>Reference</u>	
Bologna	2.0	Panalaks	(1976)
Frankfurters	2.0	Panalaks	(1976)
Smoked Herrings	15.0	Panalaks	(1976)
Bacon	0.5	Panalaks	(1976)
Smoked Ham	0-0.2	Panalaks	(1976)
	3.6-14.6	Toth	(1971)
Smoked Sausages	1.2	Howard	(1969)
	0-2.0	Panalaks	(1976)
	0-33	Toth	(1972)
Charcoal-broiled Hamburger	0-11	Panalaks	(1976)
	30	Lijinski	(1967)
Grilled Hamburger	0.05	Lintas	(1979)
	2.6-20.0	Lijinski	(1967)
Olive Oil	3.6	Lintas	(1979)
	0.5	Bracco	(1973)

Table IV

Analyses of BaP in Coffee

<u>Sample</u>	<u>No. Samples Analyzed</u>	<u>No. Samples Where Found</u>	<u>Level Apparent BaP mcg/kg</u>
Roasted and Ground	13	8	0.5 to 3
Soluble	20	9	0.1 to 0.7

Table V

Damaged Green Coffees Examined

<u>Number Analyzed</u>	<u>Comments</u>	<u>Number Contaminated</u>		
		<u>Aflatoxin</u>	<u>Ochratoxin</u>	<u>Sterigmatocystin</u>
15	damaged	NA (1)	NA	none
58	damaged	none	NA	NA
267	hand-cleaned (from moldy lots)	NA (1)	19 (2)	NA

(1) - NA: not analyzed.

(2) - Toxin levels (mcg/kg): 1 at 360, 13 at ca. 20, 5 at ca. 40

Table VI

Summary of
Commercial Green Coffee Surveys

<u>Samples Analyzed</u>	<u>Samples Contaminated</u>			<u>Reference</u>
	<u>Aflatoxin</u>	<u>Ochratoxin</u>	<u>Sterigmatocystin</u>	
640	none	NA (1)	NA	Procter & Gamble
22	none	NA	NA	Nestle's
502	none	none	none	IllyCafe
68	NA	3 (3)	NA	General Foods
201	2 (2)	2 (4)	none	FDA, USA
	-----	-----	-----	
No. samples analyzed for each toxin	1365	771	703	
No. Samples contaminated	2	5	none	

(1) - NA: not analyzed.

(2) - Toxin level (mcg/kg): 1 at 3, 1 at 12

(3) - Toxin level (mcg/kg): 1 at 80, 2 at ca. 20

(4) - Toxin level (mcg/kg): 1 at 96, 1 at 24

References

1. Cook, J.W., Hewett, C. and Hieger, I., *Nature*, 926 (1932)
2. Kuratsune, M., *J. Natl. Cancer Inst.* 20, 37 (1958)
3. Kuratsune, M. and Huerper, W.C., *J. Natl. Cancer Inst.* 24,463 (1960)
4. Chassevent, F. and Heros, M., *Cafe, Cacao, The* 7 (4) 349 (1963)
5. Pertoldi-Marletta, G., *Atti IV Convengno Nazionale della Qualita* 3,15 (1963)
6. Calzolari, C. and Pertoldi-Marletta, G., *3rd Int. Coll. Chem. Coffee* 248 (1967)
7. Grimmer, G. and Hildebrandt, H., *Dtsch. Lebensm. Rdsch.* 68, 19 (1966)
8. Fritz, W., *Nahrung* 12, 8, 799 (1968)
9. Maier, H.G. and Stender, W., *Dtsch. Lebensm. Rdsch.* 65 (11) 341 (1969)
10. Fritz, W., *Dtsch. Lebensm. Rdsch.* 65 (3) 83 (1969)
11. D'Arrigo, V., *Quaderni Di Merceologia* 10, 1, 27 (1971)
12. Bracco, V., *J. Appl. Bact.* 36 (4) 619, (1963)
13. Strobel, R.G.K. *6th Int. Coll. Chem. Coffee* 128 (1973)
14. Soos, K. and Fozi, I., *Edesipar* 25 (1) 7; (2) 37; (3) 65 (1974)
15. Fritz, W., *Ernaehrung Forschung* 20 (2) 49 (1975)
16. Lintas, C. and DeMattaeis, M.C., *Food Cosmet. Toxicol.* 17, 325 (1979)
17. Das, B.S. and Thomas, G.H., *Anal. Chem.* 50,7,967 (1968)
18. Guerrero, H., Biehl, E.R. and Kenner, C.T., *J. Assoc. Assoc. Off. Analyt. Chem.* 59 (5) 989 (1976)
19. Panalaks, T., *J. Environm. Sci. Health* 11 (4) 299 (1976)
20. *Pure Appl. Chem.* 50, 11, 12, 1763 (1968)
21. Howard, J.W., Fazio, T., White, R.H., and Klimeck, B.A., *J. Assoc. Analyt. Chem.* 51,12 (1968)
22. Grimmer, G. and Bohnke, H., *J. Assoc. Off. Analyt. Chem.* 58, 4, 725 (1975)
23. *Official Methods of Analysis of the Assoc. Off. Analyt. Chem. Mtd.* 21.001, 12th Ed., (1975)
24. Genest, C. and Smith, D.M., *J. Assoc. Off. Analyt. Chem.* 47, 5, 894 (1964)
25. Howard, J.W., Turicchi, E.W., White, R.H. and Fazio, T., *J. Assoc.Off. Analyt. Chem.* 49, 6, 1236 (1966)
26. White, R.H., Howard, J.W. and Barnes, C.J., *J. Agric. Food Chem.* 19, 1, 143 (1971)
27. *Official Methods of Analysis of the Assoc. Off. Analyt. Chem. Mtd.* 15.012 (European Decaff. Assoc.)
28. Levi, C.P., Trenk, H.L., Yeransian, J., *7th Int. Coll. Chem. Coffee*, 287 (1975)
29. Levi, C.P., and Borker, E., *J. Assoc. Off. Analyt. Chem.* 51, 3,600 (1968)
30. Levi, C.P., Trenk, H.L. and Mohr, H.K., *J. Assoc. Off. Analyt. Chem.* 57, 866 (1974)
31. Procter and Gamble, private communication
32. Nestle's, private communication
33. Iilly Caffee, private communication
34. Purchase, I.F.H. and Pretorius, M.A., *J. Assoc. Off. Analyt. Chem.* 56, 225 (1973)
35. Stoloff, L. and Francis, O., Private communication

PHYSICAL PROPERTIES AND BEHAVIOUR OF CAFFEINE AND ITS AQUEOUS SOLUTIONS



H. Bothe

Dr H. BOTHE, Prof. Dr H. K. CAMMENGA
Institut für Physikalische Chemie der
Technischen Universität Braunschweig
Hans-Sommer-Str. 10, D-3300 Braunschweig, F.R.G.

Introduction

Caffeine is one of the major constituents of coffee beans, which contain between 0.8 % (coffea arabica Santos) and 2.5 % (coffea robusta Angola). Caffeine further occurs in tea, maté, guarana, cacao and cola nuts. In the production of decaffeinated coffee, caffeine is extracted from green beans [1]. This caffeine finds extended use in the production of beverages, pharmaceuticals and foods, because there is a preference to use natural instead of synthetic caffeine. Until now caffeine has been extracted from the presteamed green beans by solvents (e.g. methylene chloride, trichlorethylene, esters) [2]. Extraction with supercritical or liquid gases, e.g. CO₂, will reach the production stage in the near future [3].

Despite of its wide occurrence, production and use insufficient quantitative data on caffeine, its hydrate and its aqueous solutions have been reported in the literature. Considerable discrepancies exist between different authors. Following a suggestion from the coffee industry, we have determined (or redetermined) many properties of caffeine, caffeine hydrate and their aqueous solutions. Some of the results will be reported in the following text.

Properties and Behaviour of Caffeine

Caffeine, 1,3,7-trimethyl-2,6-dioxopurine, was first thoroughly purified, inter alia by repeated recrystallization from pure organic solvents or from water or by zone-melting and subsequent sublimation in high vacuum starting from a DAB 7 material. The purity was determined by quantitative DTA (Du Pont 990 Thermal Analyzer, Thermanalyse MCB and Mettler TA 2000). Table 1 lists some of the samples analyzed.

Table 1: Purity of Caffeine Samples

From technical hydrate	99,7 - 9	mol-%
DAB 7 (HAG AG, Bremen, F.R.G.)	99,93 - 95	mol-%
Purified by zone-melting	}	mol-%
Twice recryst. from distilled water		
Recryst. from benzene or ethanol		
National Soft Drink Association, U.S.A., reference sample	99,97 - 98	mol-%
WHO reference sample (see VOS [4])	99,95	mol-%

Our method of measurement and evaluation was checked by analyzing naphthalene/azobenzene mixtures of known composition. As we have observed, quantitative DTA is a rapid and convenient method for measuring the purity of caffeine in the range 97 ... 100 mol-% with an accuracy in impurity content of about 20 %.

The melting point of caffeine was found to be 236.0 ± 0.2 °C (measured directly and by DTA using pure tin for calibration). Most literature data are in good accord with this value. The density of caffeine, determined by the floatation method, is 1.45_4 g cm⁻³ at 25 °C, which differs considerably from the two literature data, namely 1.23 g cm⁻³, reported by PFAFF [5] in 1831 and 1.730 g cm⁻³ given by WOLLMANN et al. [6]. The enthalpy of fusion is $\Delta H_f^0 = 21.6 \pm 0.5$ kJ mol⁻¹ and the heat capacity has also been determined [7].

At 140 ± 2 °C a first order phase transition with $\Delta H_t^0 = 4.1 \pm 0.2$ kJ mol⁻¹ has been observed to occur in anhydrous caffeine. Fig. 1 shows the X-ray diffraction pattern as a function of temperature exhibiting the phase transformation [8] as well as the dehydration of caffeine hydrate (see below). The high temperature α -phase, if quickly cooled below the transformation temperature, is metastable at room temperature. Only



Fig. 1: X-ray diffraction pattern of caffeine as a function of temperature

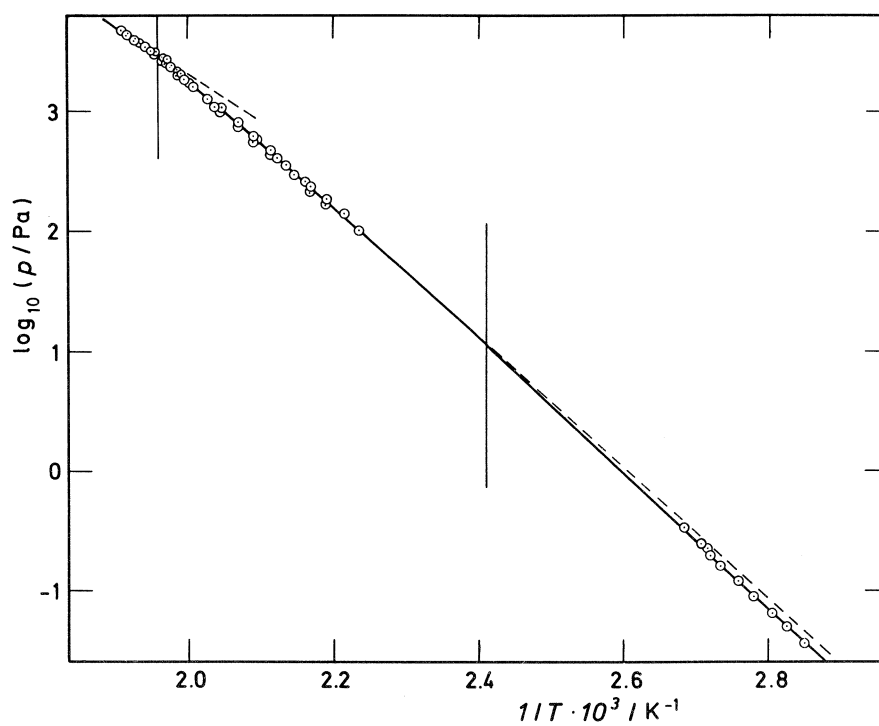

Fig. 2: Vapour pressure of caffeine

within months, it fully reconverts to the stable β -phase, which may cause some problems in practice as described below.

Fig. 2 shows a plot of the vapour pressure data determined for β -, α - and liquid caffeine as a function of the reciprocal KELVIN temperature. Unfortunately, the vapour pressure is too small at tolerable temperatures to permit decaffeination of green beans by a pure thermal process.

Properties and Behaviour of Caffeine Hydrate

Upon crystallization from aqueous solutions caffeine forms a hydrate. From pure solutions caffeine hydrate generally emerges as white, long, silky needles whereas from technical solutions often crystals several millimeters thick and with a yellow to brownish colour are obtained (see fig. 3). Upon dehydration, the crystals become brittle and opaque. The density of caffeine hydrate was found to be 1.42_4 g cm^{-3} at 25°C .

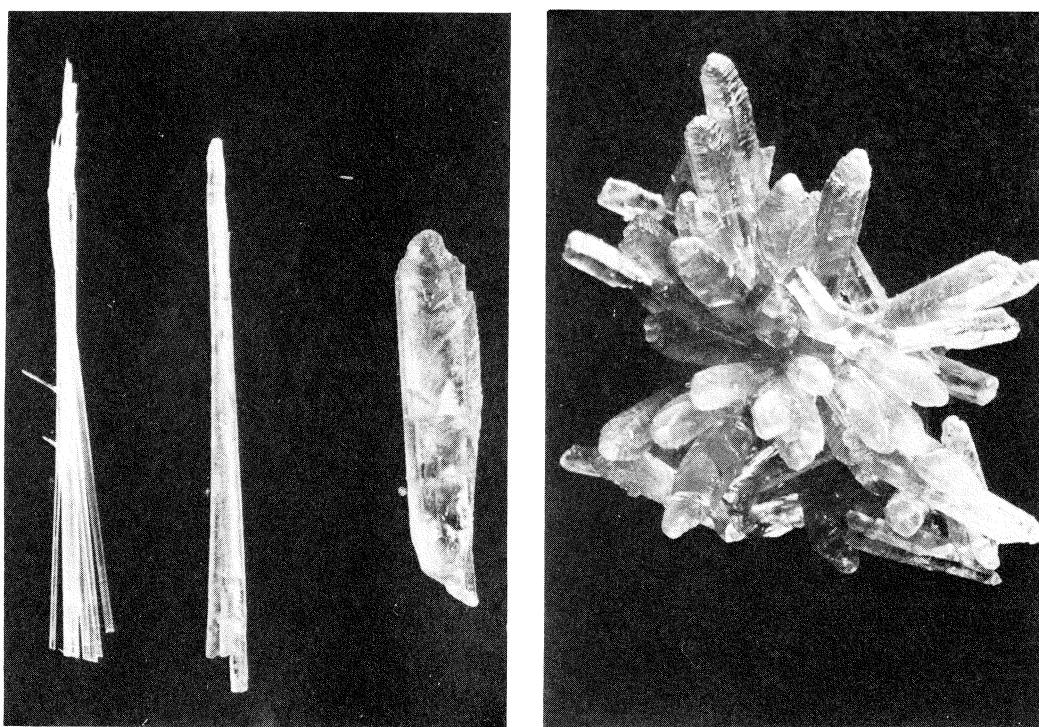

Fig. 3: Crystals of caffeine hydrate. From left to right: needles from pure solution, thin and thick crystal from technical solutions, crystal agglomerate from technical solution

With two exceptions, in the overwhelming part of the literature and in all the handbooks caffeine hydrate is cited as a monohydrate (with 8.48 weight-% H₂O), whereas our series of gravimetric studies have revealed that it is in fact a 4/5 hydrate with 6.95 weight-% H₂O [9]. This is also in good accord with a preliminary X-ray structure determination [10] and with data of WATERS and BEAL [11].

Concerning the stability point of caffeine hydrate (the temperature up to which it is stable under its own water partial pressure) two contradictory results are given in the literature: Whereas OECHLER [12] deduces 44 °C from his data of solubility and water vapour partial pressure as a function of temperature, KREMANN and JANETZKY [13] obtain 61 °C from their solubility data. In view of these discrepancies we have performed measurements of the stability point by prolonged isothermal tempering of caffeine hydrate in gas-tight capsules and a subsequent analysis of the dehydration peak by DSC. As a result of a series of measurements we have obtained a stability point of 51.5 ± 0.7 °C.

The enthalpy of dehydration ΔH_D^0 was measured as well by DSC as by solution calorimetry. The results of both methods are in good accord, $\Delta H_D^0, 298 = 7.06 \pm 0.14 \text{ kJ mol}^{-1}$ [14]. This energy constitutes only 17 % of the total energy for calcination of caffeine hydrate after recrystallization of the crude technical product from water. Following the dehydration process, caffeine is first obtained in a metastable modification, with an energy content about 1.1 ... 1.6 kJ mol⁻¹ higher than stable β-caffeine (see below).

Using different methods we have also determined the kinetics of dehydration of crystalline caffeine hydrate in the range 20 ... 73 °C. The reaction



follows first order kinetics with an activation energy $E_A = 94 \pm 3 \text{ kJ mol}^{-1}$ [14]. Crystals obtained from crude technical solutions show rates of about one tenth of those obtained for hydrate needles from pure aqueous solutions. This corresponds well with the ratio of crystal diameters [15], since it was observed microscopically that in general the reaction front started from the crystal surface and by and by moved through the crystal body. Typical times for 99 % dehydration of technical crystals are: at 25 °C about 2200 h, at 50 °C about 110 h and at 70 °C about 20 h.

Aqueous Caffeine Solutions

Many authors [12, 13, 16-22] have measured the solubility of caffeine in water, of caffeine in organic solvents and of mixtures of caffeine and other compounds in water, the latter mainly to study solubilization effects. For applications in practice, the solubility of caffeine in water should be known with a high degree of accuracy, e.g. for purification of the crude technical product by recrystallization and for pharmaceutical applications. However, the literature data on solubility, which are in tolerable agreement at ambient temperature, differ up to 300 % at elevated temperatures, see fig. 4. We have thus decided to redetermine the solubility of caffeine in water.

In our measurements both the analytical and the synthetic method have been applied. In the analytical method, by means of a special pipette a known mass of solution has been taken from a saturated solution at constant, known temperature and the caffeine content has been determined gravimetrically. In the synthetic method, weighed masses of water and caffeine have been sealed in a glass tube. This glass tube has been continuously tilted in a constant temperature bath, the temperature of which has been raised every two to three days. The temperature of complete disappearance of the last crystals gives the corresponding saturation point. In the case of caffeine, both methods have their advantages and drawbacks. There are problems with evaporation of the stock solution and adhesion of solution to the pipette in the case of the analytical method, while the synthetic method is time-consuming and it may be difficult to observe the last crystal(s) to disappear.

The results of both methods are plotted in fig. 5 as the logarithm of the caffeine solubility versus the CELSIUS temperature. The solubility may be expressed analytically by the empirical equation:

$$\lg (c_s / g_{\text{coff}} / 100 g_{\text{H}_2\text{O}}) = - 0,2391 + 0,022505 \cdot \vartheta / ^\circ\text{C}.$$

For practical purpose small differences in the solubilities of caffeine and caffeine hydrate are neglected in this equation.

Some solubilities at distinct temperatures are listed in table 2.

Table 2: Solubility of Caffeine in Water

$\vartheta / ^\circ\text{C}$	0	25	40	50	60	75	100
g C/100 g H ₂ O	(0,58)	2,11	4,58	7,69	12,92	28,11	(102,7)

(): extrapolated values

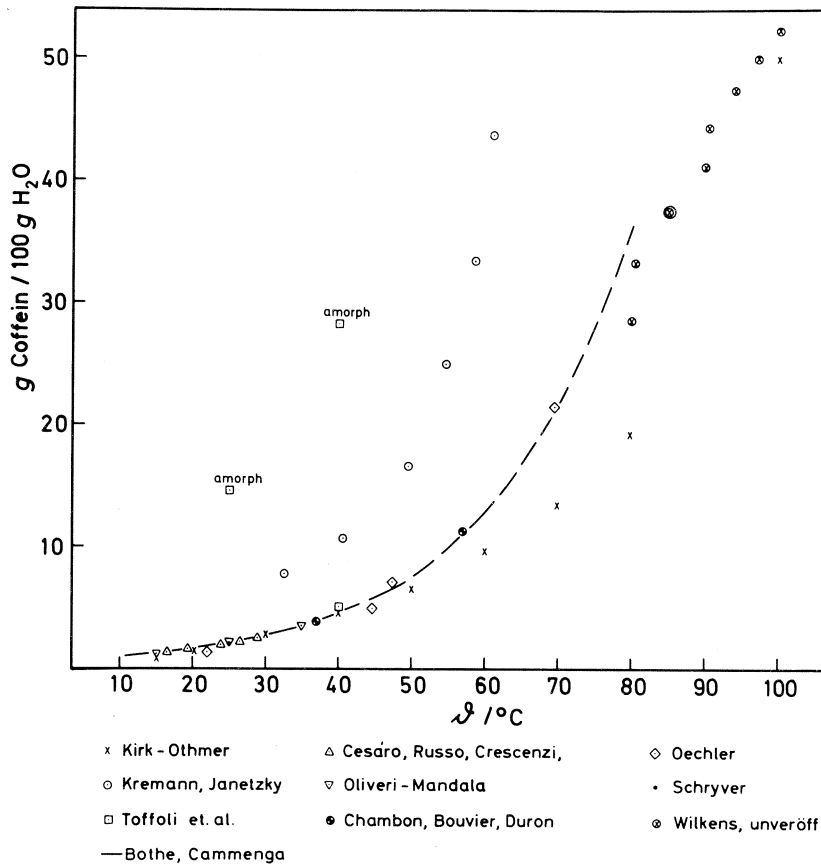

Fig. 4: Solubility c_s of caffeine in water (in g caffeine/ 100 g water)

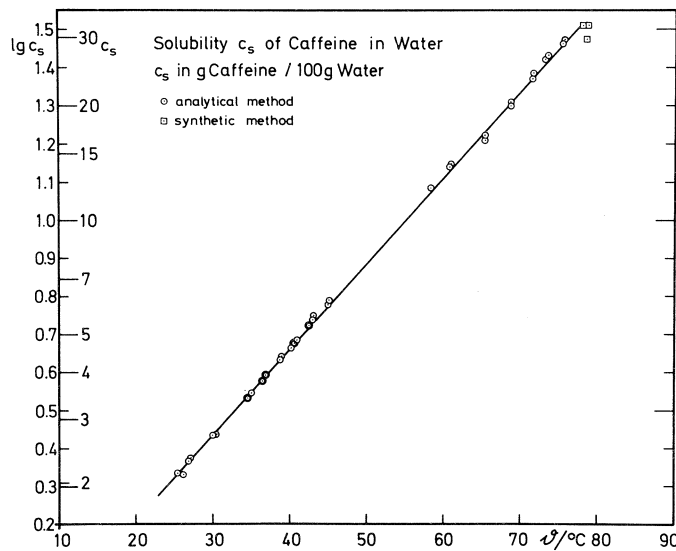

Fig. 5: Decadic logarithm of the solubility c_s of caffeine in water as a function of temperature

Complications, irrespective of the method of determination, arise in the solubility measurements and probably have caused the considerable scatter of the data of other authors:

1. Below 51.5 °C caffeine hydrate and above 51.5 °C anhydrous caffeine is stable in contact with an aqueous solution. In determining the solubility, one has thus to use the stable form at the respective temperature or to wait for days to allow supersaturations to decay, since the hydration/dehydration reaction is relatively slow.
2. As described above, caffeine may emerge in a metastable modification if freshly prepared by dehydration of its hydrate. If recrystallized from organic solvents, part of the caffeine is also obtained in a metastable modification (both effects are due to OSTWALD's step rule). Such samples exhibit a higher solubility and a lower heat of solution. To allow recrystallization to the stable β -caffeine, such samples must be tempered for some days at about 135 °C.
3. At higher temperatures, the solubility of caffeine is considerable. This is caused by intermolecular interaction, dimers and higher aggregates being formed in a process called basestacking, which is very often the case with purines. This base-stacking according to our observations is also a slow process.

We are continuing our solubility measurements using the synthetic method to obtain even more reliable data.

Concerning the crystallization from aqueous solutions, further complications arise. If solutions are cooled, starting at a temperature close to the stability point, needles of caffeine hydrate are obtained without complications. These can easily be filtered. If, however, crystallization is started well above the stability point to obtain a high yield, a precipitate is often obtained (aptly called "cottage cheese" in practice), which consists of tiny caffeine crystals and is difficult to separate by filtration. This previously unexplained behaviour may now be understood and avoided.

After having become familiar with the complex behaviour of caffeine in aqueous solution we have determined the enthalpy of solution of β -caffeine in water as function of concentration at the temperatures 25,00 °C, 35,00 °C and 42,10 °C using the LKB 8700-1 solution calorimeter. Owing to the (exothermic) base-stacking mentioned above, the enthalpy of

solution decreases considerably with increasing caffeine concentration. Since the enthalpy of solution and its dependence on temperature and concentration is not so important for practical applications, the results will be presented in a future paper.

Discussion and Outlook

From our investigations on the properties of caffeine, caffeine hydrate and their aqueous solutions the following conclusions may be drawn, which already have found application in practice:

The purity of caffeine may conveniently and accurately be determined by quantitative DTA or Differential Scanning Calorimetry.

Caffeine cannot be removed from coffee beans by a pure thermal process at reduced pressure.

The vapour pressure data can be used to predict the desorption temperature range of adsorptives in the destruction process.

The crystallization and solubility behaviour of caffeine strongly depends on the nature of the undissolved solute (β - or α -phase or hydrate).

The hydrate under its own water vapour partial pressure is stable up to 51.5 °C. It obviously plays an important (yet unknown) role in the decaffeination process with supercritical gases (e.g. CO₂, C₂H₄), since these have to contain an appreciable water content to be effective.

We thank Arbeitsgemeinschaft Industrieller Forschungsvereinigungen (AIF), Köln, and Forschungskreis der Ernährungsindustrie e.V., Hannover, for financial support. We are further indebted to Drs. K. SYLLA and J. WILKENS, HAG AG, Bremen, for continuous encouragement and interest.

References

1. O. EICHLER, Kaffee und Coffein, 2nd ed., Berlin/Heidelberg/New York: Springer 1976
2. J.R. FELDMANN and S.N. KATZ, Encyclopedia of Chemical Processing and Design 5 (1977) 424-40: "Caffeine"
3. K. ZOSEL, Angew. Chem. 90(1978) 748-55
4. H.L. VOS, Pharm. Weekblad 104 (1969) 619-29
5. C.H. PFAFF, Journ. Chem. Phys. 61 (1831) 492
6. H. WOLLMANN, B. SKALETZKI and A. SCHAAF, Pharmazie 29(1974) 708-11
7. H. BOTHE and H.K. CAMMENGA, J. Therm. Anal. 16 (1979) 267-75
8. We are indebted to Dr. H.G. WIEDEMANN, Mettler AG, Greifensee, Switzerland, for an invitation and the opportunity to use newly developed equipment.
9. H. BOTHE and H.K. CAMMENGA, Thermochim. Acta, 40 (1980) 29-39
10. R. GERDIL and R.E. MARSH, Acta Crystallogr. 13 (1960) 166-7
11. K. L. WATERS and G.D. BEAL, J. Am. Pharm. Ass. Sci. Ed. 35 (1946) 12-14
12. F. OECHLER, Pharm. Zentralhalle Dtschl. 85 (1944) 1-4
13. R. KREMANN and E. JANETZKY, Monatsh. Chem. 44 (1923) 49-63
14. H. BOTHE and H.K. CAMMENGA, Proc. 9th Int. Symp. React. Solids, Cracow, Poland, in press
15. H. BOTHE, Ph.D. thesis, Technische Universität Braunschweig, 1980, p. 88 ff
16. KIRK-OTHMER, Encycl. of Chem. Technology, 2nd ed., Vol. 3, p. 911-17 "Caffeine"
17. F. TOFFOLI et al., Annali di Chimica 63 (1973) 1-5
18. A. CESARO, E. RUSSO and V. CRESCENZI, J. Phys. Chem. 80 (1976) 335-39
19. E. OLIVERI-MANDALA and L. IRRERA, Gazet. Chim. Ital. 60 (1930) 872-7
20. M. CHAMBON, J. BOUVIER and P. DURON, Bull. Soc. Chim. [5] 4 (1937) 1401-7
21. J. WILKENS, HAG AG., Bremen, F.R.G., pers. comm.
22. A. SCHRYVER, Proceed. Royal. Soc. 83 B (1910) 123

IDENTIFIZIERUNG UND QUANTIFIZIERUNG EMETISCH WIRKSAMER BESTANDTEILE IN RÖSTKAFFEE

W. A. KÖNIG, W. RAHN, R. VETTER

Institut für Organische Chemie und Biochemie,

Universität Hamburg, D-2000 Hamburg 13

Chlorogensäure (1) ist mit 5 - 11 % Anteil ein Hauptbestandteil des Rohkaffees. Beim Röstprozess werden erhebliche Mengen an Chlorogensäuren zu phenolischen Produkten abgebaut, die teilweise emetisch wirksam sind, wie im Tierversuch an Tauben festgestellt werden konnte¹. Zur Erhöhung der Bekömmlichkeit des Kaffees werden technische Verfahren eingesetzt, mit denen eine selektive Reduzierung der Emetica erreicht werden soll, wobei natürlich darauf zu achten ist, dass das typische Aroma des Kaffeegetränkes erhalten bleibt.

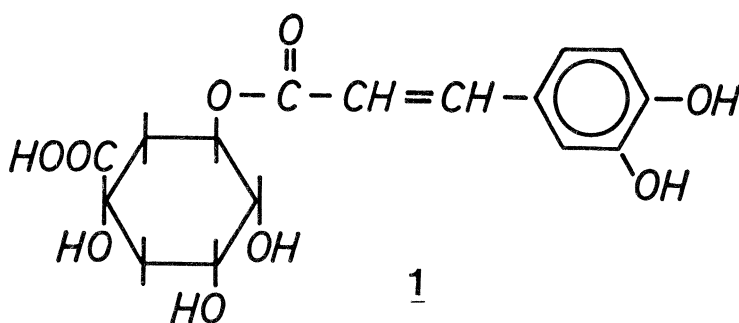

Untersucht man den Etherextrakt eines angesäuerten Kaffeeaufgusses mit Gaschromatographie und Massenspektrometrie, so lassen sich als Hauptkomponenten Furfurylalkohol, Brenzcatechin, 4-Ethylbrenzcatechin, 1,2,3-Trihydroxybenzol und 1,2,4-Trihydroxybenzol nachweisen²⁻⁵. Die emetische Wirkung dieser Stoffe scheint gesichert. Die Mengenverhältnisse dieser Komponenten des Kaffee-Extraktes hängen vom Röstgrad ab.

Seit längerer Zeit ist bekannt, dass bei einer Behandlung von Rohkaffee mit übersättigten Wasserdampf Abbauprozesse stattfinden, wodurch die Bekömmlichkeit des Produktes verbessert wird⁶. Der objektive Nachweis der besseren Bekömmlichkeit eines bearbeiteten Kaffees ist jedoch auch mit den modernen analytischen Methoden nur schwer zu erbringen.

Wir haben die Einwirkung eines neueren Bearbeitungsverfahrens (KVV-Verfahren)⁷, das eine Weiterentwicklung des Lendrich-Verfahrens darstellt und bei dem u.a. ebenfalls eine Wasserdampfbehandlung von Rohkaffee durchgeführt wird, untersucht. Die bessere Bekömmlichkeit des so bearbeiteten Kaffees konnte durch eine klinisch-physiologische Studie nachgewiesen werden⁸. Im Rahmen unserer Untersuchungen wurden umfangreiche Analysen des bei der Wasserdampfbehandlung anfallenden Kondensats und ein qualitativer und quantitativer Vergleich der extrahierbaren emetischen Stoffe aus angesäuerten Aufgüssen bearbeiteter und un bearbeiteter Röstkaffeeproben durchgeführt.

Kondensat der Wasserdampfbehandlung

Im Etherextrakt des Wasserdampfkondensats (Abb. 1) treten als Hauptkomponenten offensichtlich Abbauprodukte der Chlorogensäure 1 (3,4-Dihydroxystyrol 5, 3,4-Dihydroxizimtsäure 6, 3,4-Dihydroxybenzaldehyd 7, 3,4-Dihydroxybenzoesäure 8, 2,4-Dihydroxybenzoesäure 9) und Feruloylchinasäure 2 (4-Hydroxy-3-methoxystyrol 3, 4-Hydroxy-3-methoxyzimtsäure 4) auf, denen alleamt emetische Wirkung zugeschrieben wird. Weiterhin lassen sich grössere Mengen an Isovaleriansäure, 2-Methylbuttersäure, 2,2-Dimethylacrylsäure und der isomeren Butandiole durch kombinierte Gaschromatographie und Massenspektrometrie identifizieren. Damit scheint sicher nachgewiesen, dass durch das Bearbeitungsverfahren die Chlorogensäuren des Rohkaffees teilweise abgebaut werden.

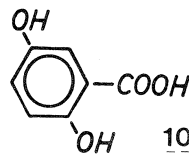
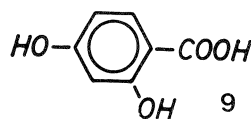
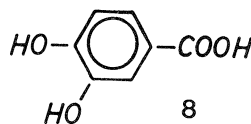
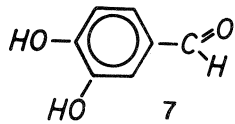
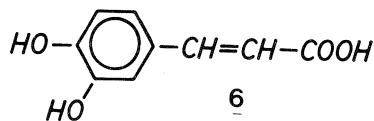
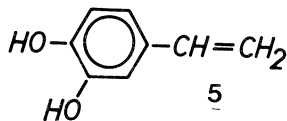
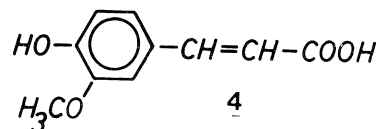
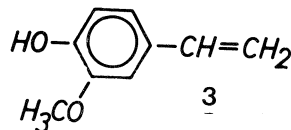
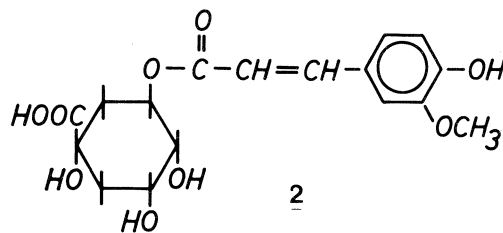



Abb. 1. Gaschromatogramm der Trimethylsilylderivate des Diethyletherextraktes eines beim KVV-Prozess anfallenden Wasserdampf-kondensates. 25 m Glaskapillare, belegt mit SE 30. Säulentemperatur : 50-230°C ; Temperaturprogramm : 3°/min. Trägergas : H₂. Peakzuordnung durch Retentionszeitenvergleich und Massenspektren.

Vergleich des bearbeiteten und unbearbeiteten Rohkaffees

Ein Vergleich des Etherextraktes von nach dem KVV-Verfahren bearbeiteten und unbearbeiteten Rohkaffee gleicher Provenienz und Charge (Abb. 2) ergab, dass 3,4-Dihydroxystyrol bereits im unbearbeiteten Rohkaffee auftritt, im bearbeiteten Kaffee jedoch mengenmässig um den Faktor 3 - 6 zunimmt. Auch diese Beobachtung deutet auf eine partielle Spaltung der Chlorogensäure bei der Wasserdampfbehandlung hin.

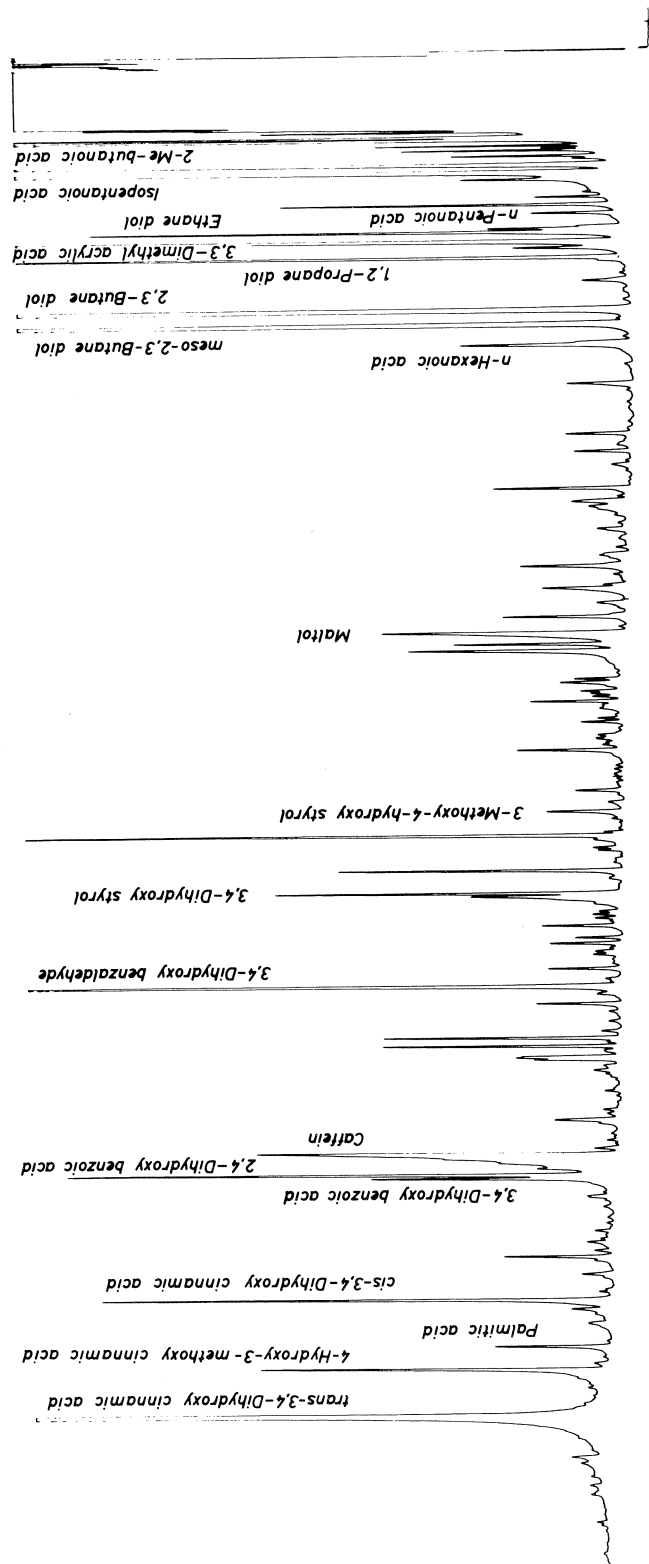

Abb.2. Etherextrakt von a) unbearbeitetem und b) bearbeitetem Rohkaffee (*Arabica neuguinea*).

Trimethylsilylderivate. 25 m Glaskapillare, belegt mit SE 30. Säulentemperatur : 100 - 250°C. Temperaturprogramm : 5°/min. Trägergas : H₂. Peakzuordnung : 1 = 3,4-Dihydroxystyrol, 2 = Palmitinsäure, 3 = Linolsäure, 4 = Stearinsäure, 5 = Kahweol, 6 = Cafestol.

Vergleich des bearbeiteten und unbearbeiteten Röstkaffees

Besonders wichtig erschien uns die Untersuchung der durch die Wasserdampfbehandlung bedingten Unterschiede im Gehalt an emetisch wirksamen Substanzen im Röstkaffee. Dabei ist es von äusserster Wichtigkeit, Kaffee gleichen Röstgrades zu vergleichen, da der durch die Röstung bedingte Chlorogensäureabbau stark vom Röstgrad abhängt.

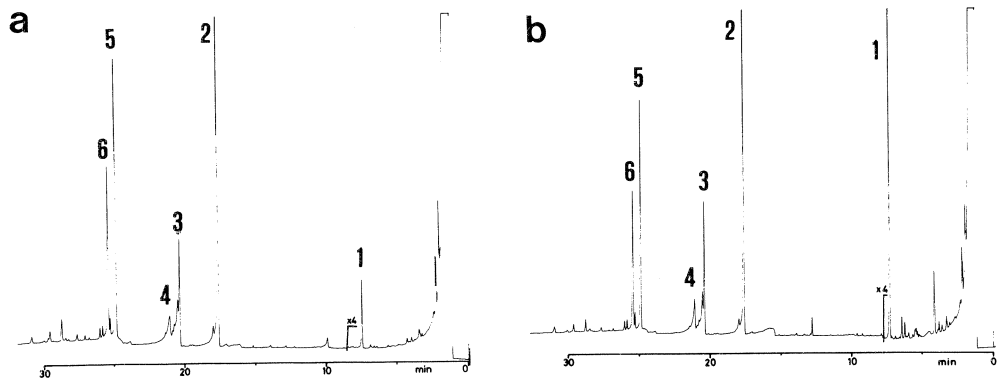
Die vergleichenden quantitativen Untersuchungen der etherlöslichen Inhaltsstoffe erfassten die in Tabelle 1 aufgeführten Substanzen. Die gaschromatographischen Bestimmungen ergaben bei bearbeitetem Kaffee für Brenzcatechin eine Abnahme um ca. 25 %, für Furfurylalkohol um ca. 10 % und für Ethylbrenzcatechin um ca. 20 %. Dabei dürfte die durch diese Wasserdampfbehandlung bewirkte signifikante Abnahme an Brenzcatechin und Furfurylalkohol für die bessere Verträglichkeit des Kaffees von besonderer Bedeutung sein.

Tabelle 1. Etherlösliche Inhaltsstoffe eines unbearbeiteten Kaffees (Arabica Salvador, Röstgrad 2,5 n. Mohr) bezogen auf Röstkaffee.

	ppm
Furfurylalkohol	560
Brenzcatechin	60
3-Methylbrenzcatechin	9
4-Ethylbrenzcatechin	9
3,4-Dihydroxystyrol	16
1,2,3-Trihydroxybenzol	35
1,2,4-Trihydroxybenzol	60
2,5-Dihydroxybenzoesäure	15

Literatur

1. G. Malorny und W. Walter, 3. Int. Koll. über Kaffee-Chemie, Triest 1967, ASIC Paris, S. 374.
2. W. Rahn und W.A. König, J. High Res. Chrom. & Chrom. Commun., 1 69, (1978).
3. W. Rahn, H.W. Meyer und W.A. König, Z. Lebensm. Unters. Forsch., 169, 346, (1979).
4. W. Rahn und W.A. König, Kaffee & Tee Markt, 30, 2, (1980).
5. W. Rahn und W.A. König, Kaffee & Tee Markt, 30, 3, (1980).
6. P. Lendrich, E. Wemmering und O. Lendrich, Verfahren zum Verbessern von Kaffee. DR-Pat. 576.515, (1933).
7. Kaffee-Veredelungs-Werk, Koffeinfrei Kaffee GmbH & Co., DT-Pat. 2.212.171, (1978).
8. V. Fintelmann, Z. Allgemein. Med., 53, 1888, (1977).

CHEMISCHE KENNZAHLEN ZUR ERGÄNZENDEN QUALITÄTSBEURTEILUNG VON ROH- UND RÖSTKAFFEE

J. WURZIGER, R. DREWS, B. SUCHE

Aus dem Hygienischen Institut der
Freien und Hansestadt Hamburg

Von den ca 70 verschiedenen Coffea-Arten - die genaue Zahl ist noch unbekannt - haben bisher nur Arten aus der Gruppe "Eucoffea" wirtschaftliche Bedeutung erlangt. In den Untergruppen der Gruppe "Eucoffea" werden insgesamt 24 Kaffee-Arten aufgeführt. Eine sichere Abgrenzung dieser Arten zueinander ist allerdings nicht bzw. nicht mehr möglich. Durch die Vielfalt der verschiedensten Entwicklungen kann auch nicht mehr sicher zwischen z.B. spontanen, fortpflanzungsfähigen Mutationen und Kreuzungen bzw. durch zufällige Fremdbestäubung entstandenen Formen unterschieden werden. Botanische Varietäten sind eigentlich nur noch als Hinweise auf die Entwicklung des Kaffeeanbaus in den jeweiligen Anbaugebieten zu werten.

Aus dieser Entwicklung ist zu verstehen, daß im Rohkaffeehandel allgemein nur zwischen Arabica- und Robusta-Arten getrennt wird. Weitergehende Unterschiede zwischen Sorten bzw. Arten werden nicht erwähnt. Abgesehen von wachstumsbedingten Einflüssen bestehen sowohl in den Tasseneigenschaften als auch in der chemischen Zusammensetzung zwischen Arabica- und Robusta-Kaffees sehr deutliche Unterschiede. Die Vielfalt der Entwicklungen hat aber auch dazu geführt, daß insbesondere bei den als Arabica, aber auch bei den als Robusta bezeichneten Sorten große, sich in den Tasseneigenschaften ausdrückenden Schwankungen festzustellen sind.

Hieraus ist auch zu verstehen, daß die Kaffeebeurteilung im Kaffeehandel sehr weitgehend bis fast ausschließlich auf die Tasseneigenschaften der Kaffees gestützt wird.

Bei dem zunehmenden Angebot von Vakuumpackungen und Ventilbeuteln mit langer Haltbarkeit und bei der in absehbarer Zeit zu erwartenden Verpflichtung zur Angabe der Mindesthaltbarkeit bei abgepacktem Röstkaffee liegt es nahe, die Qualitätsbeurteilung durch chemische Kennzahlen zu ergänzen.

Mit den nachfolgenden Untersuchungen an Roh- und Röstkaffees verschiedener Arten und Provenienzen soll ein Einblick in die Möglichkeiten vermittelt

werden, die bestehen, um die über die Tassenprobe ermittelte Qualität durch chemische Kennzahlen zu ergänzen und damit die Herstellung von Röstkaffee-mischungen vergleichbarer Qualität zu erleichtern.

Die Untersuchungen wurden in der früher beschriebenen Weise 1) ausschließlich an Petrolätherextrakten (PAe-Extrakten) vorgenommen. Die ergänzende Beurteilung erstreckt sich damit auf den Kaffeeölgehalt, das Verhalten des Fettes gegen Kaliumjodid-Eisessig (KJ/Eisessig) sowie auf die Alkalifarbzahl vor und nach dem Waschen der PAe-Auszüge mit Wasser (AFZ-Differenz).

In Tabelle 1 sind Untersuchungsergebnisse zusammengefaßt, die an SHG-Arabica-Kaffees als El Salvador und Nicaragua gewonnen wurden.

Tabelle 1 (siehe Anlage)
Zusammensetzung von SHG-Arabica-Roh- und Röstkaffees
aus El Salvador und Nicaragua

Zur Gewinnung der Kaffeeöle wurden die gemahlten Produkte drei Stunden mit PAe am Soxhlet extrahiert. Bekanntlich wird mit dieser Extraktionsweise nicht die gesamte im Rohkaffee vorkommende Kaffeeölmenge erfaßt. Dies beruht zumindest teilweise darauf, daß bei der Rohkaffeezerkleinerung stets ein gröberer und ein feiner Teil anfällt. Dies beruht aber auch darauf, daß Kaffeeöle eine andere Zusammensetzung haben als übliche Samenöle.

Die Rohkaffees aus El Salvador ergaben mehr Kaffeeöle als die aus Nicaragua. Dagegen waren die KJ/Eisessig-Extinktionen in den Nicaragua-Rohkaffeeölen höher als in den El Salvador-Rohkaffeeölen.

Unter den gewählten Versuchsbedingungen wurden aus den gemahlten Röstkaffees zwischen 43 % und 55 % Kaffeeöle mehr extrahiert als aus den Rohkaffees. Die zwischen El Salvador- und Nicaragua-Rohkaffees im Gehalt an Diterpenen festgestellten Unterschiede treten bei den Röstkaffees besonders deutlich auf. Zumindest in Einzelfällen lassen sich Kaffees aus solchen Anbaugebieten auch über solche Untersuchungen erkennen.

Die Alkalibehandlung der PAe-Auszüge vor und nach dem Waschen mit Wasser führte zu AFZ-Differenzen zwischen 1,24 und 1,73. Dabei waren die AFZ-Differenzen für die Nicaragua-Röstkaffees am größten.

Wenn von den wachstumsbedingten arteigenen Besonderheiten der Kaffees abgesehen wird, dann geben die AFZ-Differenzen die nach

1) Wurziger, J., R. Drews und G. Bundesen, 8. Internationales wissenschaftliches Kolloquium über Kaffee, 28.11. - 3.12.1977 in Abidjan

der Tassenprüfung vorliegenden Kaffeequalitäten recht gut wieder. In Tabelle 2 sind nochmals Arabica-Kaffees zusammengefaßt und zwar aus Kenia, Mexico, Honduras, Columbien und Costa Rica.

Tabelle 2 (siehe Anlage)
Zusammensetzung von Arabica-Roh- und Röstkaffees aus
Kenia, Mexico, Honduras, Columbien und Costa Rica

Im Kaffeeölgehalt bestanden zu den Arabicas in Tabelle 1 keine merkbaren Unterschiede. Dies trifft auch weitgehend auf die Extinktionen für die Umfärbungen der Kaffeeöle mit KJ/Eisessig zu.

Aus den gemahlten Röstkaffees wurden unter den gewählten Versuchsbedingungen zwischen 40 % und 48 % mehr Kaffeeöle extrahiert. Damit bestand auch in dieser Hinsicht zu den Röstkaffees in Tabelle 1 kein wesentlicher Unterschied.

Nach den auf Kaffeeöl bezogenen KJ/Eisessig-Extinktionen sind die meisten Kaffees in Tabelle 2 den Nicaragua-Kaffees in Tabelle 1 ähnlicher als den Kaffees aus El Salvador. Dies gilt jedoch nur für die zufällig gewählten Produkte.

Die AFZ-Differenzen betragen für diese Röstkaffees in Tabelle 2 zwischen 1,34 und 2,68. Auch für diese Röstkaffees gaben die AFZ-Differenzen die bei der Tassenprobe gewonnenen Eindrücke recht gut wieder. Hiernach kann allgemein davon ausgegangen werden, daß hohe AFZ-Differenzen bei frisch gerösteten und qualitativ hochwertigen Kaffees angetroffen werden. AFZ-Differenzen lassen damit auch zumindest in vielen Fällen Rückschlüsse auf die etwa vorliegende Kaffeequalität zu. Auf Veränderungen, die während der Lagerung gerösteter Kaffee in z.B. Vakuumpackungen oder in Ventilbeuteln auftreten, soll in diesem Zusammenhang nicht eingegangen werden.

Handelsübliche Röstkaffees sind in der Regel Mischungen aus Kaffees sehr unterschiedlicher Herkunft und Güte. In Tabelle 3 sind Untersuchungsergebnisse zusammengefaßt, die an Handelsprodukten vergleichbaren Röstgrades, aber sehr unterschiedlicher Tassenqualität gewonnen wurden.

Tabelle 3 (siehe Anlage)
Zusammensetzung von handelsüblichen Röstkaffees

Die Kaffeeölgehalte waren sehr ähnlich. Es bestanden auch zu den in früheren Tabellen aufgeführten Röstkaffees keine bemerkenswerten Unterschiede. Dies gilt auch sehr weitgehend für die Farb-Extinktionen, die beim Erhitzen mit Kaliumjodid und Eisessig auftreten. Auf Kaffeeöl bezogen, errechneten sich Extinktionen zwischen 6,8 und 10,3. In diesen Grenzen bewegen sich die Extinktionen im allgemeinen auch bei handelsüblichen Röstkaffees, sofern ausschließlich Arabica-Kaffees verwendet wurden.

Als AFZ-Differenzen ergaben sich für die gewählten Beispiele 1,16 bis 2,0. Die AFZ-Differenzen entsprachen etwa den Tasseneigenschaften. AFZ-Differenzen bis etwa 1,5 werden bei Röstkaffees kleiner bis mittlerer Arabica-Röstkaffeequalitäten gefunden, bei qualitativ hochwertigen Arabica-Röstkaffees liegen die AFZ-Differenzen höher und erreichen Werte bis 2,0 und sogar darüber.

In Tabelle 4 sind Untersuchungsergebnisse zusammengestellt, die an verschiedenen Robusta-Kaffees ermittelt wurden. Als Beispiele wurden Robusta-Kaffees aus Laos, Cameroun und Angola gewählt.

Tabelle 4 (siehe Anlage)
Zusammensetzung von Robusta Roh- und Röstkaffees
verschiedener Herkunft

Im Kaffeeölgehalt bestanden zu den Arabica-Kaffees in den Tabellen 1 bis 3 sehr deutliche Unterschiede. Nach den AFZ aus den unteren Phasen der Petrolätherextrakte lagen frischerntige Rohkaffees vor. Mit Kaliumjodid und Eisessig ergaben die Kaffeeöle aus den Robustas keine Grünverfärbungen. Die schwache Extinktion beim Laos-Robusta ist auf das Vorliegen einzelner Arabica-Bohnen zurückzuführen. Darauf kommt es aber in diesem Zusammenhang nicht an.

Unter den gewählten Versuchsbedingungen wurden aus den gemahlten Robusta-Röstkaffees bis 78 % mehr Kaffeeöle extrahiert als aus den gemahlten Rohkaffees. Dieser sehr große Unterschied beruht nicht allein auf dem Zerkleinerungsgrad der Rohkaffees.

Aus den Extinktionen für die Kaliumjodid-Eisessig-Reaktion ergaben sich auf Kaffeeöl umgerechnet - Extinktionen zwischen 1,1 und 0,2. Auch hieraus ist zu erkennen, daß im Laos-Robusta einzelne Arabica-Kaffeebohnen vorlagen.

Dies konnte über Einzelprüfungen an Kaffeebohnen aus der Laos-Kaffee-Partie nachgewiesen werden.

Die AFZ-Differenzen betragen für diese ausgewählten Robusta-Kaffees 0,74 bis 0,80. Unabhängig davon, daß die AFZ-Differenzen recht dicht beieinander lagen, bestehen zu den angeführten Arabica-Röstkaffees sehr große Unterschiede.

Robusta-Kaffees enthalten bekanntlich mehr Chlorogensäuren als Arabica-Kaffees. Auf die AFZ-Differenzen wirken sich aber bei Robusta-Kaffees die Zersetzungsprodukte der Chlorogensäuren weniger stark aus. Darauf kann aber in diesem Zusammenhang nicht näher eingegangen werden.

Robusta-Kaffees sind nach diesen Beispielen nicht nur über die Kaliumjodid-Farbreaktion von Arabica-Kaffees zu unterscheiden, sondern sie weichen auch in den AFZ-Differenzen ähnlich eindeutig von Arabicas ab.

In Tabelle 5 sind Untersuchungsergebnisse zusammengestellt, die an Kaffees aus Kreuzungen zwischen Arabicas und Robustas ermittelt wurden. Bei diesen Produkten handelt es sich um "Catimor-Kaffee" aus Brasilien und um "Arabusta-Kaffee" aus Côte d'Ivoire.

Tabelle 5 (siehe Anlage)
Zusammensetzung von Kreuzungs-Röstkaffees
verschiedener Art

Unter den gewählten Versuchsbedingungen wurden aus den angeführten Röstkaffees zwischen 11,1 % und 12,6% Kaffeeöle gewonnen. Zu den angeführten Robusta-Röstkaffees besteht ein deutlicher, zu den Arabica-Röstkaffees besteht jedoch kein auswertbarer Unterschied. Röstkaffees mit solchen Kaffeeölgehalten kommen sogar sehr häufig vor. Beim Erhitzen mit Kaliumjodid-Eisessig entstanden Umfärbungen, für die Extinktionen zwischen 0,118 und 0,946 erhalten wurden. Aus den Extinktionen für die KJ/Eisessigreaktion und den Fettgehalten errechneten sich Extinktionen zwischen 1,0 und 7,4. Dabei zeigt der "Catimor-Kaffee" aus Brasilien die stärkste Färbung. Aus der KJ-Eisessig-Farbreaktion ist also nicht auf einen Kreuzungskaffee zu schließen. Da Catimor auch, wie bereits früher berichtet 1) wurde, in den Getränken keine Robustanote zeigt, läßt sich "Catimor-Kaffee" überhaupt nicht als Kreuzungskaffee erkennen. Daraus kann aber auch gefolgert werden, daß viele andere bekannte Arabica-Kaffees solche oder ähnliche Kreuzungen sind. Wenn gleichzeitig bedacht wird, daß z.B. *Coffea stenophylla* mit KJ/Eisessig überhaupt die bisher bekannten stärksten Umfärbungen liefert, während *Coffea liberica* sich in dieser Weise wie *Coffea robusta* verhält, dann ist leicht zu erklären, daß eine Zuordnung der Handelskaffees zu den verschiedenen *Eucoffea*-Untergruppen nicht mehr möglich ist.

Für die Arabusta-Kaffees wurden bei vergleichbaren Kaffeeölgehalten wesentlich kleinere und gleichzeitig sehr unterschiedliche Extinktionen mit KJ/Eisessig erhalten. Über Untersuchungen an einzelnen Kaffeebohnen läßt sich bei Arabusta-Kaffees nachweisen, daß es sich um Kreuzungen handelt.

Besonders interessant sind die AFZ-Differenzen für die in Tabelle 5 angeführten Röstkaffees. Für Catimor-Kaffees betrug die AFZ-Differenz 2,10. Sie entsprach damit einem recht guten Arabica-Kaffee. Für die Arabusta-Kaffees wurden AFZ-Differenzen von 1,25 und 0,84 erhalten. Arabusta-Kaffees mit einer AFZ-Differenz von 1,25 entspricht einem Röstkaffee etwa mittlerer Qualität. Anzumerken bleibt hier, daß Getränke aus diesem Arabusta-Kaffee sehr neutral waren und keine Robustanote erkennen ließen. AFZ-Differenz und KJ-Eisessig-Reaktion würden zunächst auf einen Mischkaffee aus Arabicas und Robustas hinweisen. Röstkaffee mit einer AFZ-Differenz von 0,84 entspricht - auch nach Tabelle 4 - normalem Robusta-Kaffee. Ein anderes Bild ergibt sich,

wenn der Kaffeeölgehalt und die Extinktion für KF/Eisessig-Farbreaktion in die Betrachtungen einbezogen werden. Die angeführten Untersuchungsergebnisse sind über Mischungen aus Arabicas und Robustas nicht bzw. nur äußerst schlecht zu erklären. Dies gilt für Arabusta-Kaffees - nach bisherigen Erfahrungen - ganz allgemein.

Unter den handelsüblichen Röstkaffeemischungen kommen auch solche mit Robusta-Zusatz häufiger vor. In Tabelle 6 sind Beispiele zusammengestellt, aus denen der Einfluß von Robusta-Kaffees auf die hier behandelten Kennzahlen zu erkennen ist.

Tabelle 6 (siehe Anlage)

Zusammensetzung von Röstkaffeemischungen aus jeweils
50 % Arabicas und 50 % Robustas

Für alle Mischungen wurde der in Tabelle 4 aufgeführte Cameroun-Robusta-Kaffee genommen. Bei den Arabica-Kaffees handelt es sich um den SHG-Costarica aus Tabelle 2 sowie um zwei bekannte handelsübliche Arabica-Kaffeemischungen. Die Kaffees wurden getrennt geröstet und nach dem Mahlen vermischt. Aus den in Tabelle 6 zusammengestellten Beispielen ist zu ersehen, daß sich der Robusta-Zusatz in einer dem Mischungsverhältnis entsprechenden Abnahme des Kaffeeölgehaltes, der Extinktion für die KJ/Eisessig-Farbreaktion sowie der AFZ-Differenz ausdrückte. Die ausgewählten Beispiele zeigen aber weiter, daß weder aus den Kaffeeölgehalten noch aus den AFZ-Differenzen, auch bei gemeinsamer Betrachtung, auf einen Robustazusatz geschlossen werden kann. Die Beurteilung ist jedoch dann leichter und meist sogar einfacher, wenn die auf Kaffeeöl bezogene Extinktion für die KJ/Eisessig-Farbreaktion in die Betrachtung einbezogen wird. Obwohl Rückschlüsse auf den zugesetzten Robusta-Anteil höchstens in Einzelfällen möglich sind, kann über diese schnell und ohne apparativen Aufwand durchführbaren Untersuchungen doch zu einer besseren Beurteilung insbesondere von gemahlten Röstkaffees beigetragen werden. Zu beachten ist jedoch, daß unter Umständen Kreuzungskaffees wie Mischungen aus Arabicas und Robustas beurteilt werden.

Bei den gewählten Mischungen von Arabicas zu Robustas wie 1: 1 war die Robustanote selbstverständlich bei allen Getränken aus diesen Röstkaffeemischungen deutlich zu erkennen. Mit den Beispielen für verschiedene Arabica-Kaffees, handelsübliche Röstkaffeemischungen, Robusta-Kaffees sowie Mischungen aus Arabicas und Robustas sollte deutlich gemacht werden, daß über wenige einfache Untersuchungen am Kaffeeöl zu einer Verbesserung der Kaffeebeurteilung beigetragen werden kann. Wenn davon abgesehen wird, daß charakteristische oder fehlerhafte Kaffeebesonderheiten überhaupt nur durch die Verkostung zu erkennen sind, dann läßt sich die Gleichmäßigkeit von schlechteren bis besten Kaffeequalitäten über die angesprochenen Kennzahlen einstellen und möglicherweise auch garantieren. Das bedeutet, daß diese aus dem Kaffeeöl ermittelten Kennzahlen bei richtiger und insbesondere vorsichtiger Einschätzung des Aussagewertes durchaus zu einer Verbesserung und Erleichterung der Kaffeebeurteilung beitragen können.

Tabelle 1
Zusammensetzung von SHG-Arabica-Roh- und Röstkaffees
aus El Salvador und Nicaragua

Bezeichnung	SHG - Arabica - Kaffees			
	El Salvador	El Salvador	Nicaragua	Nicaragua
<u>Herkunft</u>				
<u>Rohkaffee</u>				
Kaffeeöl %	9,31	9,05	8,61	8,07
Extinktion KJ/Eisessig	0,657	0,542	0,917	0,740
Extinktion für 100 mg Kaffeeöl	7,0	6,0	10,7	9,2
<u>Röstkaffee</u>				
Kaffeeöl %	13,47	12,90	12,50	12,40
Extinktion KJ/Eisessig	0,911	0,761	1,570	1,196
Extinktion für 100 mg Kaffeeöl	6,8	5,9	12,6	9,6
Alkalifarbzahl, Differenz	1,24	1,39	1,73	1,48

Tabelle 2
Zusammensetzung von Arabica-Roh- und Röstkaffees aus
Kenia, Mexico, Honduras, Columbien und Costa Rica

Bezeichnung	Arabica-Kaffees				
	Kenia	Mexico	Honduras	Columbian	Costa-Rica
<u>Herkunft</u>					
<u>Rohkaffee</u>					
Kaffeeöl %	9,60	8,59	8,65	9,45	9,31
Extinktion KJ/Eisessig	0,659	1,006	1,378	1,086	0,731
Extinktion für 100 mg Kaffeeöl	6,9	11,7	15,9	11,5	7,9
<u>Röstkaffee</u>					
Kaffeeöl %	13,65	12,21	11,85	14,08	13,47
Extinktion KJ/Eisessig	1,019	1,350	1,760	1,314	1,239
Extinktion für 100 mg Kaffeeöl	7,5	11,5	14,9	9,3	9,2
Alkalifarbzahl, Differenz	1,70	1,34	2,14	1,72	2,68

Tabelle 3
Zusammensetzung von handelsüblichen Röstkaffees

Bezeichnung	Röstkaffee					
	1	2	3	4	5	6
Kaffeeöl %	13,23	10,60	13,30	13,24	12,76	14,11
Extinktion KJ/Eisessig	1,33	1,02	1,30	1,06	1,17	0,96
Extinktion für 100 mg Kaffeeöl	10,3	9,6	9,8	8,0	8,4	6,8
Alkalifarbzahl Differenz	1,16	1,16	1,31	1,35	1,67	2,00

Tabelle 4
Zusammensetzung von Robusta-Roh- und Röstkaffees
verschiedener Herkunft

Bezeichnung	Robusta-Kaffees		
	Laos	Cameroun	Angola
<u>Rohkaffee</u>			
Kaffeeöl %	4,91	4,32	4,91
Extinktion KJ/Eisessig	0,044	0,001	0,011
Extinktion für 100 mg Kaffeeöl	0,009	0,00	0,003
<u>Röstkaffee</u>			
Kaffeeöl %	7,64	7,59	6,64
Extinktion KJ/Eisessig	0,085	0,013	0,029
Extinktion für 100 mg Kaffeeöl	1,1	0,2	0,4
Alkalifarbzahl, Differenz	0,74	0,80	0,74

Tabelle 5
Zusammensetzung von Kreuzungs-Kaffees
verschiedener Art

Bezeichnung	Catimor	Kreuzungskaffee	
		Arabusta	Arabusta
Herkunft	Brasilien	Côte d'Ivoire	
<u>Röstkaffee</u>			
Kaffeeöl %	12,6	11,1	11,8
Extinktion KJ/Eisessig	0,946	0,247	0,118
Extinktion für 100 mg Kaffeeöl	7,5	2,2	1,0
Alkalifarbzahl, Differenz	2,10	1,25	0,84

Tabelle 6
Zusammensetzung von Röstkaffeemischungen aus
jeweils 50 % Arabicas und 50 % Robustas

Bezeichnung	Kaffeeöl %	KJ/Eis- essig- Ext.	KJ/Eis- essig- Ext./öl	AFZ-Dif- ferenz
Costa-Rica-Arabica	13,47	1,239	9,2	2,68
Cameroun-Robusta	7,59	0,013	0,2	0,80
Mischung 1:1	11,47	0,518	4,5	1,82
Arabica-gemisch 1	13,35	1,300	9,7	1,84
Cameroun-Robusta	7,59	0,013	0,2	0,80
Mischung 1:1	10,54	0,489	4,6	1,37
Arabica-gemisch	14,11	0,955	6,8	2,00
Cameroun-Robusta	7,59	0,013	0,2	0,80
Mischung 1:1	10,95	0,383	3,5	1,42

CAFFEINE METHODOLOGY : SEMI-AUTOMATIC METHOD FOR THE DETERMINATION OF CAFFEINE IN GREEN AND PROCESSED COFFEES



K. G. SLOMAN

General Foods

Technical Center

Tarrytown, New York

Introduction:

Methods for the determination of caffeine in coffee have changed dramatically in the last twenty years, turning more and more toward simplified, rapid, instrumental procedures. The official methods of the Association of Official Analytical Chemists (A.O.A.C.) (13) have changed first from the macro Bailey-Andrew to the similar but simplified micro Bailey-Andrew (2,3), then to a radically different approach, the chromatographic spectrophotometric method of Levine (11), first adopted with slight modification for decaffeinated products in 1965 (4), and then after further modification, for all coffee products in 1979 (15). This method has also been collaboratively studied by ISO and approved as an official method (18). Aside from these official methods there has been a steady stream of published methods describing the analysis of coffee for caffeine by a variety of different techniques. Among these are thin layer chromatographic methods (9,20), voltametry (17), differential spectrophotometry (8), gas chromatography (5,16,19), automatic analysis (6), and in the last few years High Pressure Liquid Chromatography (1,12,21).

At General Foods, we have followed all these techniques with great interest and examined many of them. However, the need in our plants was for a rapid, accurate caffeine method suitable for Quality Control. The method was required to handle large numbers of samples, and to be capable of use by relatively unsophisticated personnel with little technical background. Since the method is used for the control of a decaffeination process, accuracy, reproducibility and speed of analysis are important.

Development of the Automatic Method:

When automatic chemical analyzers were introduced in the 1960's, these seemed to offer an answer to the above requirements. Technicon Auto Analyzer equipment was used in building the first automatic caffeine set up (7). This was an extremely simple system. The caffeine was extracted from the coffee by hot water or magnesium oxide digestion, and the filtrate was then placed on the Auto Analyzer sampler. On the Auto Analyzer the caffeine was extracted into trichlorethylene and the absorbance of the extracted caffeine read on a spectrophotometer. To compensate for other constituents, also extracted, each type of coffee was run against a matching standard, green coffee against a green standard, decaffeinated coffee against a decaffeinated standard, etc. The caffeine contents of the stan-

dards were obtained by careful analysis by the AOAC official methods, micro Bailey-Andrew for undecaffeinated samples, and the spectral-chromatographic method for decaffeinated samples. This method was used quite successfully for a number of years until it was discovered that with the changes occurring in the world wide coffee situation and with the availability of new varieties of coffee, erratic and erroneous results could be obtained unless the green coffee standard was an exact match for the coffee being analyzed. This was further compounded by the discovery that the detectors being used were not linear with respect to response for increasing caffeine concentrations. The new coffees and blends would require the use of several green standards, and the detectors would have to be replaced. At about this time trichlorethylene was replaced as a solvent, and chloroform as replacement appeared to extract more interference from the coffee. It was felt that this was the time to develop a better automated method.

The Current Automatic Method:

The ultimate goals of the new method were 1) the method must be based on the use of an absolute standard, 2) it should have one pretreatment and one Auto Analyzer manifold configuration for all kinds of coffees, 3) the results should be rapid and accurate for plant control (i.e., intra-laboratory collaborative studies), and 4) it must be capable of being performed by non-professional personnel. These goals were not all completely obtained. The method is currently performed by non-professionals, it is rapid and accurate, the Auto Analyzer manifold is the same for all coffees, and pure caffeine is used as the standard. However, it was found necessary to employ different extraction and clarification procedures for different kinds of coffees.

Essentially the method consists of extraction either with hot water or by boiling with magnesium oxide. The filtrate from the extraction is clarified off the analyzer by the use of zinc ferrocyanide or potassium permanganate. If the latter is used the excess is destroyed with hydroxylamine. The sample is then placed on the analyzer where it is treated with a basic reagent, sodium hydroxide, then extracted into chloroform and the caffeine determined by the absorbance reading at 276 m μ . Results are calculated from the absorbance of pure caffeine solutions run under the same conditions on the Auto Analyzer.

The extraction and clarification techniques are based on suggestions found in the literature on caffeine methodology. Magnesium oxide (13), zinc ferrocyanide (14) and potassium permanganate clarification (10) have all been suggested and tested as clarifying reagents for the determination of caffeine. Hydroxylamine is used to destroy unreacted permanganate rather than hydrogen peroxide to prevent the formation of gas bubbles in the Auto Analyzer lines, and rather than sodium sulphite to prevent the formation of another U.V. absorbing substance. Sodium EDTA is used as an agent for removing any manganese dioxide which might precipitate in the system since caffeine is quickly destroyed in the presence of manganese dioxide. The treatment with permanganate is varied slightly between the different types of coffees because of the relative amounts of interferences encountered. The actual analysis time by this system from "start" to "finish", for ten determinations, could be as little as one hour and a half or as long as two hours and a half. Actual through time on the Auto Analyzer is about six minutes and a sample is analyzed every two minutes.

All results were compared to those obtained by the AOAC official methods. A summary of this comparison is shown in Table 1. The Auto-Analyzer results tend to be slightly higher than the results by the official method, particularly on undecaffeinated coffees, yet U.V. curves on the caffeine in the chloroform extract show no signs of any interfering material. The data on the precision of the method is shown in Table 2; the overall average coefficient of variation is $\pm 4.5\%$. Table 3 shows the results of a recent study in which three analysts analyzed a set of nine Robusta coffees each in duplicate. The overall coefficient of variation for caffeine, d.b. is $\pm 3.4\%$ on these samples.

We have found it necessary for the best precision to insist on rigid adherence to the written procedure and to the details of the apparatus set-up. To ensure consistent and accurate results all Quality Control Laboratories and our research laboratories use the same equipment down to the identical flow cells, spectrophotometers and recorders. This may not be necessary, but it enables us to set and control as one of our cardinal check points the factor (mg % caffeine divided by absorbance) for the caffeine standard. This is rigidly maintained at 10 ± 1.0 for all laboratories. Another check point is the use of a

control sample, not a standard, but a known sample whose variation in value may be used to check errors before they get out of control. The internal diameter and length of transmission lines is also rigidly controlled. While this method will work well with other automatic equipment we have found that rigidly maintaining these restrictions ensures agreement between our laboratories. Absolute cleanliness is also important and therefore cleaning procedures have become part of the method.

We have suggested the use of displacement bottles for the chloroform for a number of reasons. The use of the bottles makes start-up slightly more complicated, but it means there are no lines pumping chloroform, and exposure of the laboratory to chloroform vapors is kept to a minimum. Since the amount of chloroform in the bottle is finite, the system cannot run forever, therefore the bottle must be refilled. However, a two liter bottle will provide a full days running time, and thus provides no hardship, and the fact that the bottle must be refilled provides a break when flow cell and apparatus can be cleaned.

Table 1

Comparison Automatic Method vs Official Method

<u>Sample</u>	<u>Av. % Caffeine</u>	
	<u>Automatic</u>	<u>Official</u>
Green Coffee		
Undecaffeinated	1.57	1.52
	2.09	1.95
	1.16	1.10
	1.35	1.23
	1.95	1.82
Decaffeinated	0.075	0.098
Roasted and Ground Coffee		
Undecaffeinated	1.57	1.54
	1.43	1.42
	1.30	1.26
	2.11	2.05
Decaffeinated	0.048	0.051
	0.089	0.087
	0.080	0.071
	0.069	0.065
	0.127	0.125
Soluble Coffee		
Undecaffeinated	3.49	3.33
	2.76	2.73
	1.83	1.78
	3.40	3.26
	3.21	3.04
Decaffeinated	0.155	0.153

Table 2

Precision of Automatic Method

<u>Type of Sample</u>	<u>No. of Analyses (Inter-laboratory studies)</u>	<u>% Caff.</u>	<u>S.D. ±</u>	<u>C.V. ± %</u>
Undecaffeinated Green	15	1.54	0.078	4.7
	15	2.07	0.088	2.0
	15	1.14	0.052	4.4
	15	1.31	0.052	3.8
	15	1.92	0.100	2.8
Decaffeinated Green	50	0.053	0.0008	1.5
	9	0.075	0.0054	7.2
Undecaffeinated Roasted and Ground	24	1.57	0.090	5.8
	24	1.43	0.076	5.3
	24	1.30	0.068	5.2
	24	2.11	0.12	5.7
Decaffeinated Roasted and Ground	68	0.048	0.0059	6.9
	32	0.049	0.0042	4.4
Undecaffeinated Soluble	29 (AGG)	3.58	0.21	5.7
	29 (AGG)	2.89	0.18	6.4
	29 (AGG)	1.88	0.10	5.5
	29 (F.D.)	3.45	0.13	3.7
	29 (AGG)	3.19	0.12	3.9
Decaffeinated Soluble	4	0.086	0.0018	2.1
	4	0.136	0.006	4.4
	4	0.252	0.006	2.3

Table 3

Green Robusta Coffee
Caffeine (d.b.)

<u>Different Varieties</u>	<u>Analyst 1</u>	<u>Analyst 2</u>	<u>Analyst 3</u>
A	2.41, 2.34	2.45, 2.39	2.52, 2.32
B	2.32, 2.31	2.29, 2.24	2.23, 2.24
C	2.26, 2.31	2.43, 2.21	2.20, 2.24
D	2.33, 2.30	2.13, 2.27	2.40, 2.26
E	(2.89), 2.11	2.02, 2.15	2.12, 2.30
F	2.10, 2.17	2.08, 2.02	2.16, 2.06
G	2.15, 2.01	2.04, 1.98	2.12, 2.02
H	2.26, 2.27	2.37, 2.45	2.31, 2.34
I	2.34, 2.24	2.08, 2.24	2.27, 2.29

On this set of data repeatability = reproducibility = ± 0.0753 - about $\pm 3.4\%$

Detailed Semi-Automatic Method

Applicable to:

Decaffeinated coffees, green, roasted and soluble;
Regular coffees, green, roasted and soluble.

Principle:

The sample is partially clarified, then put on the Auto-Analyzer where clarification is completed; caffeine is extracted into chloroform and read at 276 nm.

Source:

General Foods Method

Apparatus:

Technicon Sampler II or IV, Cam 30/Hr 1/1
Technicon Pump II or III
Hitachi Spectrophotometer Model 100-4008 or equivalent
Flow Cell Beckman No. 886710, 10 mm quartz
Recorder with scale expansion, IX and 2X
Coffee Grinder
Volumetric Flasks
Hot plate
Whatman Filter Paper, fluted 2V (18.5cm)
Auto-Analyzer tubing, coils etc. for flow system
Bottles, 2 liter, narrow neck with 2 hole rubber stoppers
Repipettes, 10 ml. and 1 ml.
See attached flow chart

Reagents:

Acetic acid, glacial
Potassium Permanganate (KMnO₄) - 1% in water. Prepare fresh weekly.
Hydroxylamine Sulfate (NH₂OH·H₂SO₄) - 2% in water
Sodium Hydroxide (NaOH) 1.0N - 40 gm per liter
Magnesium Oxide (MgO) Heavy, U.S.P.
Disodium ethylene diaminetetracetic acid
(Na₂EDTA) Technical salt - 1% and 2% in water.
Chloroform, A.C.S. grade

* ! SAFETY PRECAUTION ! *
* *
* Chloroform is a volatile solvent whose vapors are poisonous *
* in high concentrations. Therefore keep all chloroform bottles *
* stoppered and all open chloroform covered with a layer of *
* water. Pour chloroform only in a hood. *

Potassium Ferrocyanide (K₄Fe(CN)₆) · 3H₂O - 105.6g to one liter with water.
Zinc Acetate (Zn(C₂H₃O₂)₂ · 2H₂O) - 110g dissolved in water, add 30 ml. glacial acetic acid and make to one liter.
Caffeine Standard U.S.P. -
Dry at 80°C for four hours in large dish and store in desiccator.

TECHNICON AUTOANALYZER METHOD Caffeine Auto-Analyzer DATE 9/16/78
 CONCENTRATION RANGE 0.5 mg % - 8.0 mg %
 TYPE SAMPLE Coffee
 REFERENCE Teflon .034
 SIGNATURE _____ AFFILIATION General Foods

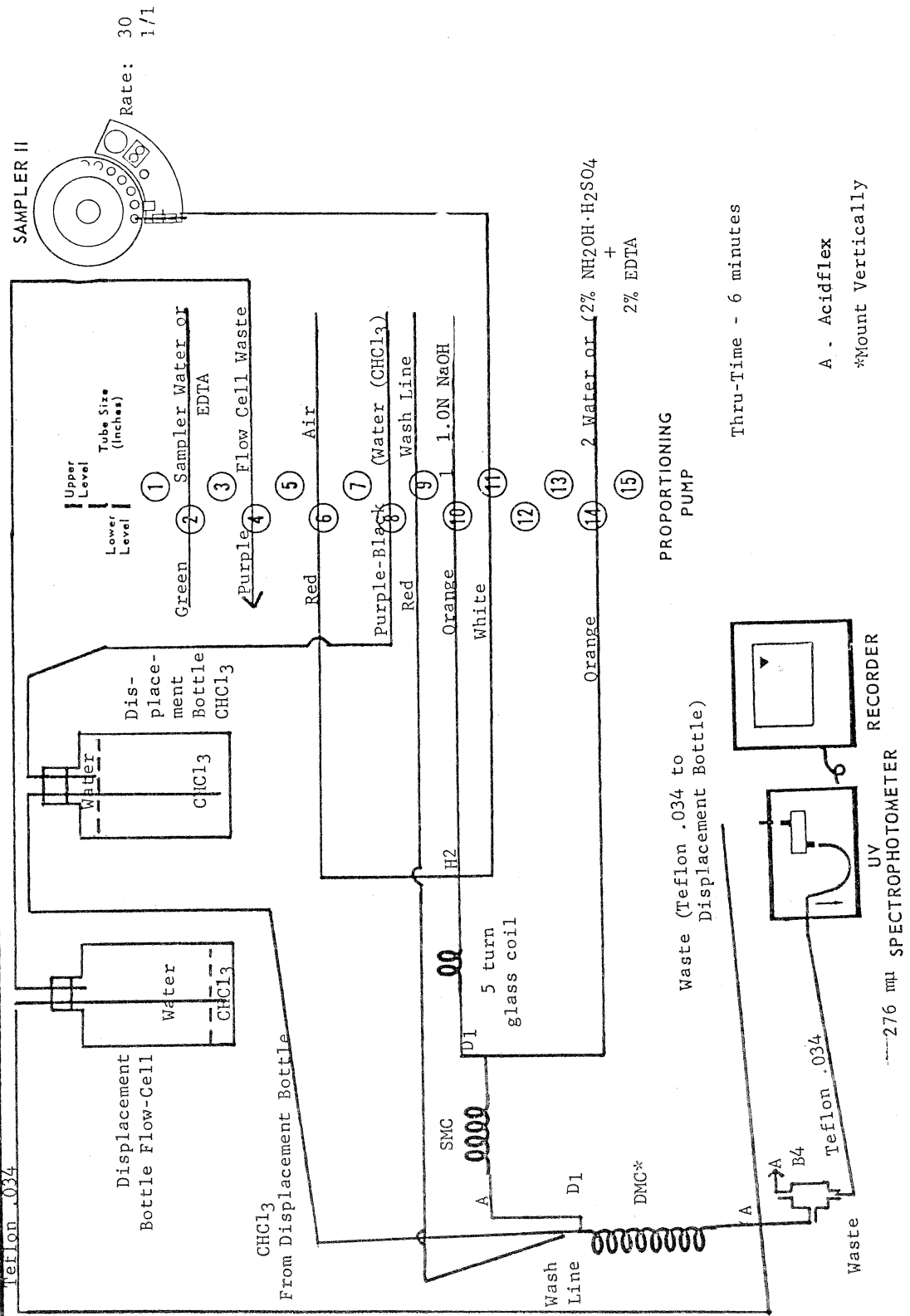

Thru-Time - 6 minutes

A. Acidflex
 *Mount Vertically

276 mμ SPECTROPHOTOMETER

Stock Standard:

Weigh 1.000 grams dried caffeine into a 200 ml. volumetric flask, dissolve in water, make to mark and mix. Discard after three months.

Working Standard:

Pipette 10 ml. of stock standard into a 100 ml. volumetric flask, make to mark with distilled water. Mix. Discard after one week.

Auto-Analyzer Standards:

Dilute working standard as follows. Prepare fresh daily.

<u>Conc. mg. %</u>	<u>ml. Working Standard</u>	<u>Volume</u>
0.5	1.0	100
1.0	1.0	50
2.0	2.0	50
3.0	3.0	50
4.0	4.0	50
5.0	5.0	50
6.0	3.0	25
8.0	4.0	25

Procedure:

Refer to chart for sample size, dilution, extraction, clarification and to determine which reagents are needed.

1. Weigh sample size indicated into proper size volumetric flask.
2. Extraction Procedures:

MgO extraction:

Add 5.0 gm. heavy MgO to flask, 50 ml. hot water and one or two boiling chips, mix. Place on pre-heated hot plate, bring to boil and boil for 1/2 hour. Shake occasionally, and if necessary, add water to break foam and keep volume at about 50 ml. Cool, make to mark and filter through Whatman No. 2V paper 18.5 cm.

Hot water extraction:

Regular Green Coffees. Add 50 ml. hot water and place on steam bath for thirty minutes, cool.

For Soluble Coffees: Add 50 ml. hot water, mix to ensure solution. Cool and make to mark, mix.

3. Clarification Procedures:

Decaff. Green coffees - None

Zinc Ferrocyanide Clarification:

Regular Green Coffees - to extracted or diluted sample in volumetric flask add:

0.5 ml. glacial acetic acid, mix

7.0 ml. zinc acetate, then with swirling

7.0 ml. potassium ferrocyanide

Mix, make to mark and mix. Filter through Whatman No. 12V paper (18.5 cm)

Permanganate Clarification:

Pipette 25 ml. of filtrate or diluted sample to a 50 ml. volumetric flask. Add glacial acetic acid or 0.1N NaOH in quantities indicated on the chart. To each flask add 5 ml. 1% potassium permanganate mix, wait the designated time, then add 5 ml. 2% hydroxylamine, swirl and make to mark. Some samples may bubble actively. Wait until bubbling subsides, then make to mark and mix cautiously. If a series of samples is being analyzed, the permanganate may be added to all the samples and then the hydroxylamine added as long as the time limits are observed (± 0.5 minute).

CAFFEINE METHODOLOGY
OUTLINE OF AUTO-ANALYZER PROCEDURES

Type of Sample	Sample Size g.	KMnO ₄ Treatment				Auto-Analyzer Reagents		Wash	Additional
		Volume	Extraction	mHAc	Time	1	2		
Decaff. Green	3.0	100	5g MgO 30'	None	None	1.0N NaOH	Water	Water	
Reg. Green	0.5	200	Hot water 30'	None	None	1.0N NaOH	Water	Water	Clarify with zinc ferrocyanide
Decaff. R&G	4.0	100	5g MgO 30'	1	10'	1.0N NaOH	EDTA + NH ₂ OH	Water	2X on Recorder
Decaff. Sol.	1.5	100	5g MgO 30'	1	10'	1.0N NaOH	EDTA + NH ₂ OH	Water	2X on Recorder
Reg. R&G	0.7	200	5g MgO 30'	2	5'	1.0N NaOH	EDTA + NH ₂ OH	Water	
Reg. Soluble	0.5	200	Hot Water	4ml 0.1N NaOH	10'	1.0N NaOH	EDTA + NH ₂ OH	Water	
Odd Soluble ^①	0.7 to 2.0	100 to 200	Hot Water	4ml 0.1N NaOH	10'	1.0N NaOH	EDTA + NH ₂ OH	Water	

^① Caffeine content above 0.4%, adjust sample size to fall in range of standards.

4. Place samples on Auto-Analyzer with standards.
 Use standards 0.5 to 4.0 mg% for decaffeinated coffees.
 Set recorder on 2X for decaffeinated R&G and soluble.
 Use standards 1.0 to 8.0 mg% for regular coffees and for blends.
 Use reagents as indicated on chart.
 Check baseline by putting two waters after every ten samples.
5. Start-up of Auto-Analyzer system.
 Fill chloroform displacement bottle to about one-inch from top with chloroform. Then fill to the top with water. Fill the waste displacement bottle with water.

It is necessary to avoid getting water in the flow cell. Therefore, pump system dry with all lines out of water (except sampler wash - but pull sampler probe out of wash cup) and flow cell not connected. Then put chloroform line (8) in water and pump until line is full of water. Insert stopper in chloroform bottle (stopper should be tight) leaving no air space and pump chloroform through separator and line leading to cell to flush out this line. Flush line leading to cell about three times with chloroform. Cell should be clean and dry.

Place stopper in waste bottle (tight) and wait about 5 seconds. Connect outlet line to cell, and then inlet line to cell.

Allow cell to fill and stabilize and set 0 and 100% T (or 0 and 1A or 2A) on spectrophotometer according to spectrophotometer instructions. When baseline has stabilized, place all reagent lines in water and note when water reaches separator. Wait about 2 minutes, check baseline, then start required reagents as indicated on chart. Finally set baseline at about 0.02 absorbance.

If at any time the baseline becomes excessively noisy, check flow cell for water or dirt; if necessary, remove and clean flow cell and repeat start-up procedure.

When all reagents have been pumping for at least ten minutes and baseline is stable, start sampler and analysis.

Calculation:

Draw baseline on chart between water samples. Read peak heights from chart of all samples and standards and subtract corresponding baseline reading from each peak.

Calculate caffeine factor for each standard:

$$F = \frac{\text{mg\%}}{\text{Peak ht. (corr)}}$$

If 1.0 mg% standard reads 0.110 - .010

$$\text{then } F = \frac{1.0}{0.100} = 10.000$$

Obtain average F for all standards.

Calculate mg% in samples:

$$\text{mg\% sple} = F \times \text{Peak ht sple (corr)}$$

If sample reads 0.210-.010

$$\text{mg\% sple} = 10.000 \times 0.200 = 2.00 \text{ mg\%}$$

Calculate % caffeine in sample from dilution employed.

$$\% \text{ Caffeine} = \frac{\text{mg\% sple} \times \text{dilution Factor D}}{\text{wt sample in gm.} \times 10}$$

Dilution Factor D =

Sple Diluted to 100	1
Sple Diluted to 200	2
Sple Diluted to 100 & Permanganate Treated	2
Sple Diluted to 200 & Permanganate Treated	4

Note:

System must be maintained clean for accurate results.

On systems where permanganate clean-up has been used, flush system by means of NaOH line (10) and for 15' at end of run with 2% hydroxylamine (or EDTA-Hydroxylamine mixture), follow with 15' flush with distilled water.

System can be cleaned by disconnecting chloroform line, placing a red line (9) on the pump and connecting it to the system at the point marked D1 on the flow diagram. Then put all lines except CHCl_3 line and sample water line, in diluted Micro solution (1 capful per pint), also put sampler probe in the Micro solution and pump Micro through system for 1/2 hour, then pump distilled water through system for 40 minutes to an hour.

Bibliography

- 1) Adams, R.F., Schmidt, G., Slavin, W., Chromatog. News1. 4, 10 (1976)
- 2) Borker, E., J. Assoc. Off. Anal. Chem. 42, 299 (1959)
- 3) Borker, E., Ibid. 43, 622 (1960)
- 4) Borker, E., Sloman, K. G., Ibid. 48, 705 (1965)
- 5) Carisano, A., Riva, M., Daghetta, A., Boll. Lab. Chim. Prov. 23, 557 (1972)
- 6) Fabre, J.C.L., Spitalier, F., Estienne, J., Ann. Fals. Exp. Chem. 72, 133 (1979)
- 7) Fazzina, T., 4th Internat. Colloq. on the Chemistry of Coffee, 97 (1969)
- 8) Ferren, W.P., Shane, N.A., J. Assoc. Off. Anal. Chem. 51, 573 (1968)
- 9) Harlos, H., Lebensmittel - Ind. 20, 412 (1973)
- 10) Ishler, N.H., Finucane, T.P., Borker, E., Anal. Chem. 20, 1162 (1948)
- 11) Levine, J., J. Assoc. Off. Agric. Chem. 45, 254 (1962)
- 12) Madison, B.L., Kozarek, W.J., Damo, C.P., J. Assoc. Off. Anal. Chem. 59, 1258 (1976)
- 13) Methods of Analysis of the Association of Analytical Chemists, Twelfth Edition, (1975) Washington, D.C., 15.022, 15.023 p. 247
- 14) Moir, D.D., Hinks, E., Analyst 60, 439 (1935)
- 15) Newton, J.M., J. Assoc. Off. Anal. Chem. 62, 705 (1979)
- 16) Schilling, R., Gal. S., Z. Lebensm. Unters.-Forsch. 153, 94 (1973)
- 17) Sontag, G., Kral K., Mikrochim. Acta. 1, 229-40 (1979)
- 18) Vitzthum, O., International Standards Organization, Document ISO/TC34/SC8/WG2 (Ser. 91) 233E of 1974-06-20 (1974)
- 19) Vitzthum, O.G., Barthels, M., Kwasny, H.Z., Z. Lebensm. Unters.-Forsch. 154, 135 (1974)
- 20) Washuettl, J., Bancher, E., Riederer, P., Ibid. 143, 253 (1970)
- 21) Wildanger, W., Dtsch. Lebensm. Rundsch. 72, 160 (1976)

AN ATTEMPT TO LOCALIZE CAFFEINE IN THE CELL BY ITS WASHOUT KINETICS

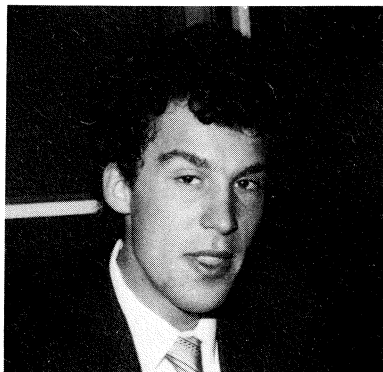

R. Pfrunder

R. PFRUNDER, dipl. Natw.,

H. WANNER, Prof. Dr,

P. M. FRISCHKNECHT, dipl. Natw.,

T. W. BAUMANN, PD Dr

Institute of Plant Biology, University of Zurich, Switzerland

Introduction

Little is known about cellular localization of caffeine. Is the purine alkaloid stored in the vacuole, in the protoplasm or in the cell wall or is it distributed evenly all over the cell? In the beginning of this century SUZUKI, DU PASQUIER, MOLISCH and WEEVERS tried to localize the caffeine, but because of its physio-chemical nature, i.e. lipo- and hydrophily, most attempts had to fail. During the 8th ASIC colloquium DENTAN reported in her studies on the fine structure of green coffee beans that she believes to have found caffeine in the cytoplasm neighbouring lipids. During infiltration of leaf discs in biosynthesis studies carried out in our laboratory, we accidentally observed the easy washout of caffeine. This gave us the possibility to approach the problem of localization by compartment analysis. Mathematical curve-peeling should give us information about number and size of the pools. As a complementary method for localization we chose the protoplast technique, which resulted in negative findings, because protoplasts became caffeine free during isolation. Nevertheless, combining the results of the two methods we are able to present a scheme of caffeine localization in the cell.

Materials and methods

Plant material. In the washout experiments we used 1-year-old plants of *Coffea arabica* var. Catuai vermelho cultivated in the phytotron (12 h light, day temperature 24°C, night temperature 18°C, relative humidity: day 80%, night 75%). For protoplast isolation 7-month-old endosperm from beans of *Coffea arabica* Bourbon Vermelho were used.

Washout experiments. We used a vessel made out of an aluminium bottom and of a plexiglass top. (See Fig. 1.) The lower part contains two plastic rings with nylon nets, which fix the leaf discs. A magnetic spinbar keeps the liquid homogeneous. Fig. 2 shows the washout equipment. An intact *Coffea*

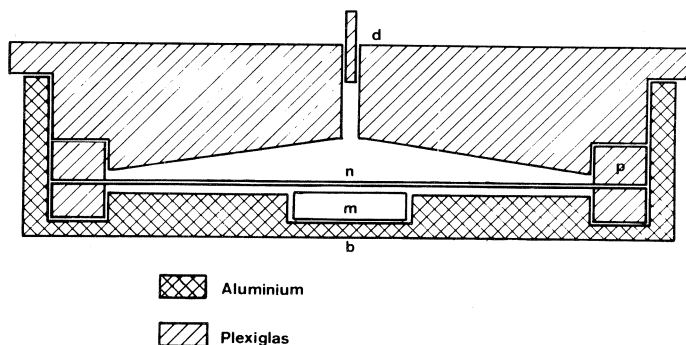

Fig. 1. Cut through a washout vessel.
 b: bottom-part (aluminium)
 d: top-part (plexiglass)
 m: magnetic spinbar
 n: nylon nets
 p: plexiglass ring

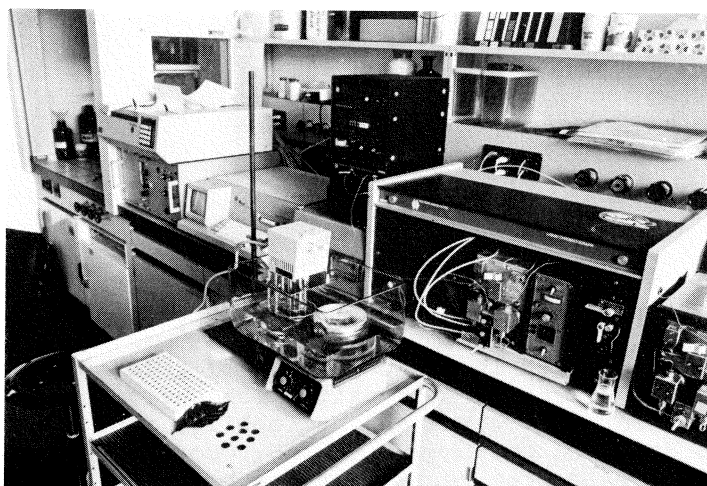

Fig. 2. Washout equipment and HPLC-unit

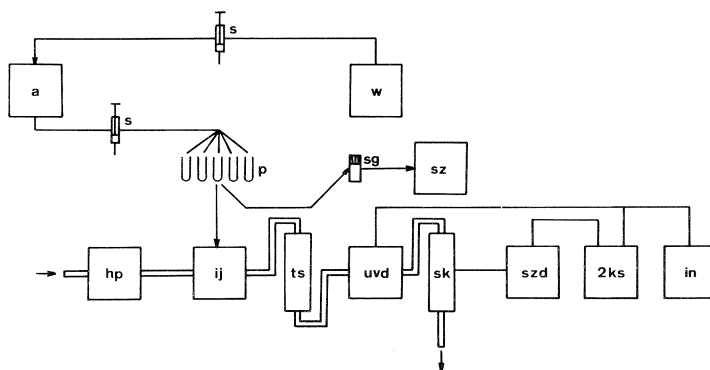

Fig. 3. Schematic illustration of caffeine analysis.
 a: washout vessel
 hp: high pressure pump
 ij: injector
 in: integrator
 p: sample vials
 s: syringe
 sg: scintillation vials
 sk: scintillation chamber
 sz: scintillation counter
 szd: scintillation detector
 ts: C18-column
 uvd: UV-detector
 w: refill water
 2ks: 2-channel plotter

arabica leaf was filled with water according to the method of HAGBORG. We have to mention that the epidermal wax layers will not permit any diffusion of caffeine out of an intact leaf, so that we had to stamp out a number (12) of leaf discs which were fixed between the two nylon nets during the washout experiments. Fig. 3 shows a process diagram of the entire caffeine analysis. In intervals 250 μ l samples were collected and from each 100 μ l were used for scintillation counting and 100 μ l for quantitative caffeine determination by HPLC. A constant washout volume was kept by adding water after each sampling. Tracer experiments were carried out with ring-marked ^{14}C -caffeine. The synthesis of the radioactive tracer was done by methylation of xanthine with dimethylsulfate (HEFTMANN).

Protoplast isolation. By using Cellulysin and Macerase (Calbiochem, San Diego, USA) in concentrations of 2 and .5% respectively we succeeded in isolating protoplasts out of Coffea arabica endosperm. After purification on Ficoll protoplasts were cracked by sonication and the resulting homogenate was extracted by chloroform. The organic phase was then examined for caffeine by thin layer chromatography.

Results

The chapter on the result will be divided into two sections, one dealing with protoplast isolation and with preliminary washout experiments, the other presenting the results of tracer experiments.

Protoplasts. Isolated and purified endosperm protoplasts did not contain significant amounts of caffeine. Most of the caffeine was released during the cell wall digesting step.

Preliminary washout experiments. They revealed that usually only 50 to 70% of the caffeine in viable leaves could be washed out (see Fig. 4). As soon as the cells were dead the total caffeine content was found in the surrounding liquid. It was proved that light has no influence on the washout kinetics (see Fig. 5). In a passive diffusion test of caffeine through dialysis membranes with a temperature increase of 10°C in the physiological range, we observed a washout acceleration by the factor of 1.1. Under the same temperature conditions we observed a factor of at least 2 in the leaf disc experiments. We do not have an explanation for this phenomenon.

Tracer experiments. In experiment A a leaf was infiltrated with .8 ml tracer and immediately washed out. If one supposes that the infiltrated caffeine is distributed in the free space, it has to be washed out more quickly than the leaf caffeine. The two curves (^{12}C and ^{14}C) in Fig. 6 show that this cannot be correct. We conclude that the membranes of the different compartments are of no notable hindrance to the caffeine. A balanced situation is reached very quickly between the infiltrated and the endogeneous caffeine. It is of some importance that the specific activity of the caffeine remaining in the leaf discs is smaller than that of the washed out purine alkaloid. The curve-peeling following the method of GOLD reveals two compartments of 13 μg and 65 μg and washout constants of 1.07 and .07 respectively. We believe that the first compartment, which is found in every experiment, is due to experimentator manipulations. At least 5 minutes pass from the beginning of the infiltration till the discs are surrounded by water. Therefore a pool is produced in the free space, which in situ is not existing and thus needs no further attention. Two possibilities are left open: Either only one pool exists which can be washed out, or there are several pools with the same washout constants.

In the following we shall call the pool which can be washed out "biosynthesis pool". In experiment B a leaf still attached to the plant was infiltrated with tracer and was washed out only after a recovery time of 6 days.

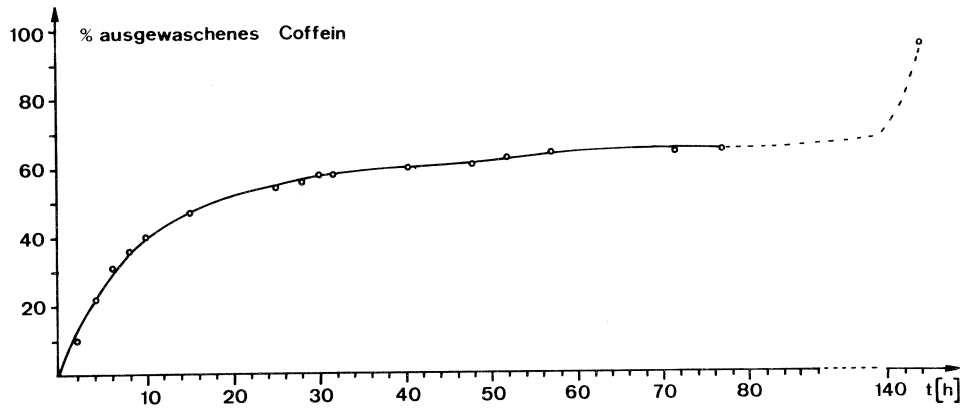

Fig. 4. Typical washout curve of leaf caffeine.
 x-axis: time; y-axis: percentage of caffeine washed out

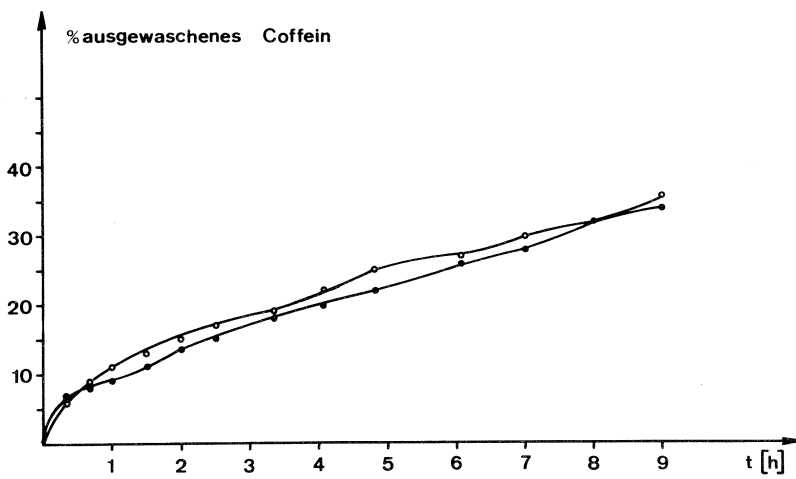

Fig. 5. Washout curves of caffeine in the light (-o-o-o-) and in the dark (-●-●-●-).
 x-axis: time; y-axis: percentage of caffeine washed out

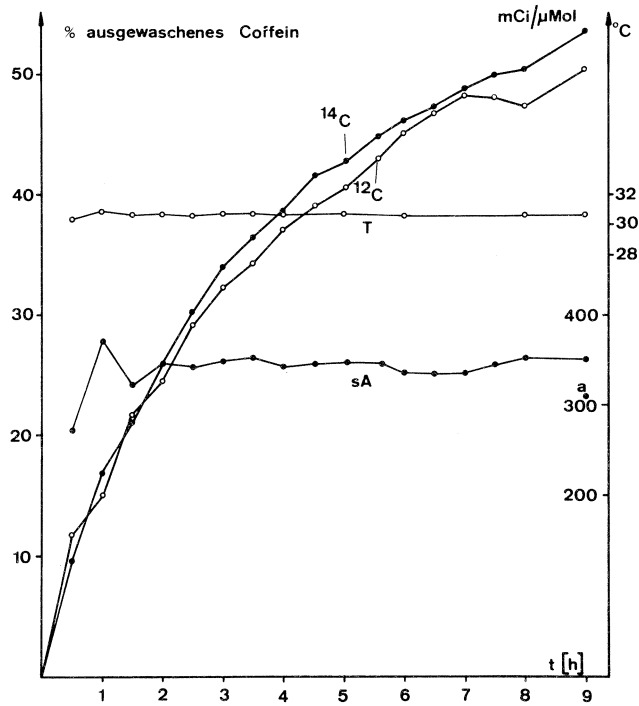

Fig. 6.
Washout curves of ^{12}C and ^{14}C -caffeine in an experiment with immediate washout.

Explanations to Fig. 6 and 7.

a: specific activity of caffeine in the leaf discs at the end of the experiment

sA: specific activity of the washed out caffeine

T: temperature

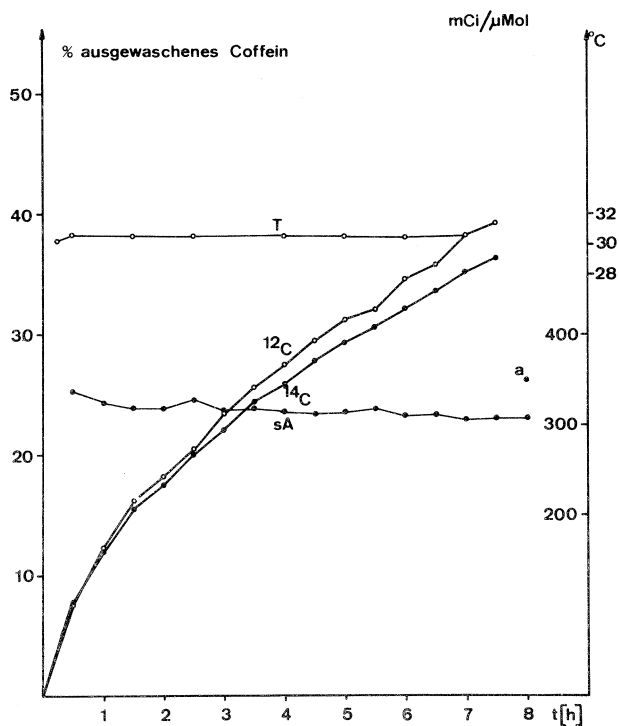

Fig. 7.
Washout curves of ^{12}C and ^{14}C -caffeine in an experiment with a recovery time of 6 days.

Fig. 7 shows the results. In contrast to experiment A the two curves are now exchanged. Proportionally more ^{12}C than ^{14}C -caffeine has been washed out. The specific activity of caffeine in the leaf discs at the end of the experiment is now higher than that in the washout water. These two facts permit us to distinguish between two types of pools of the caffeine remaining in the discs: One, which may be defined as "final-storage" pool cannot be manipulated by the experimentator, whereas the other, called "pre-storage pool", exchanges ^{14}C -caffeine against ^{12}C -caffeine. Considering all results the localization of caffeine in a schematic cell may look as it is shown in Fig. 8:

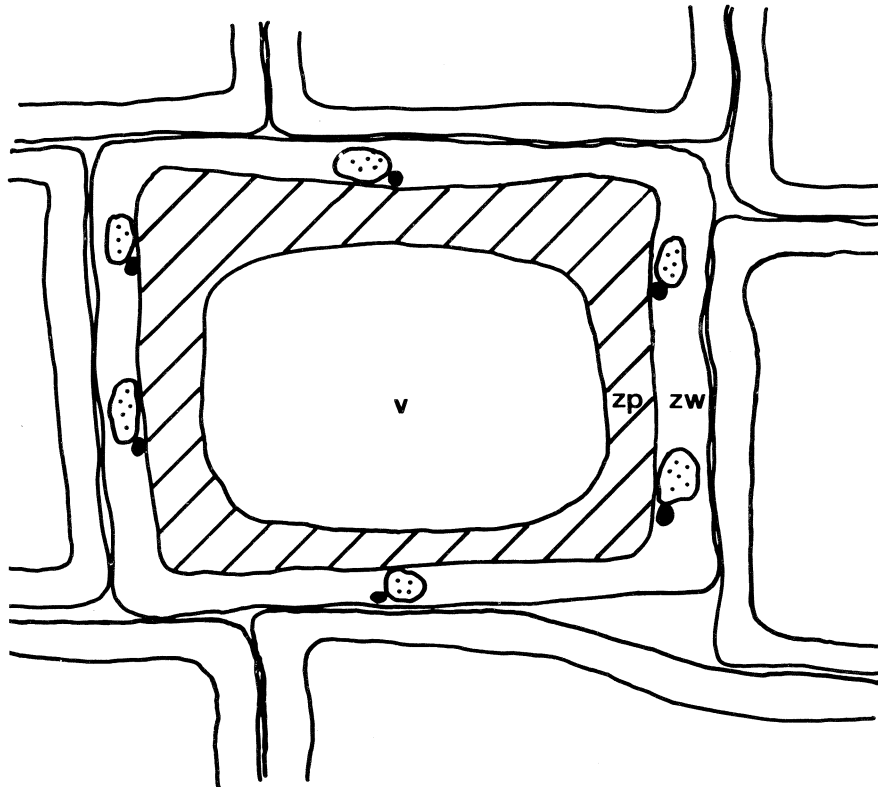

Fig. 8. Caffeine localization in a schematic cell.
v: vacuole, zp: cytoplasm, zw: cell wall



"free" caffeine, is easily washed out



stored caffeine, is not washed out or exchanged



stored caffeine, is not washed out, but can be exchanged

Localized in the cell wall structures are the two storage pools, whereas the biosynthesis pool obviously has to be located in the cytoplasm. This matches nicely the results of DENTAN's work: Histochemical localization in the cell wall of the potential caffeine complexor chlorogenic acid and in situ crystallization of caffeine in the cytoplasm. Our results do not permit us to decide whether the "free" caffeine can also be found in the vacuole and in the cell wall.

In summary, there is no fixed or complexed caffeine in either vacuole or cytoplasm. The vacuole is therefore not a caffeine storage pool. We distinguish two types of stored caffeine incapable of being washed out. Both of them are localized in the cell wall. One is accessible from the outside, the other not. At least 50% of total caffeine can be washed out and is considered to form the biosynthesis pool with uncertain location.

References

- DENTAN, E.: Structure fine du grain de café vert; 8th International Colloquium on Coffee ASIC 1977.
- DU PASQUIER, P.: Beiträge zur Kenntnis des Thee. Inaug. Diss. Zürich (1908).
- GOLD, H.J.: Mathematical modeling of biological systems, Wiley, New York (1977) 129-132.
- HAGBORG, W.A.F.: A device for injecting solutions and suspensions into thin leaves of plants. Can. J. Bot. 48 (1970) 1135-1136.
- HEFTMANN, E.: Synthesis of caffeine-2-¹⁴C. J. Lab. Cpd. 7 (1971) 463-465.
- MOLISCH, H.: Mikrochemie der Pflanze. 2. Aufl. 1922, Gustav Fischer, Jena.
- SUZUKI, M.: Contribution to the physiological knowledge of the teaplant; Bull. of Agriculture Tokyo, Vol. IV.
- WEEVERS, T.: Die Funktion der Xanthinderivate im Pflanzenstoffwechsel; Arch. néerl. Sci., III B 5 (1930) 111-195.

Acknowledgments

We were financially assisted in this work by the Swiss National Science Foundation. We thank Mr. H. Pfrunder for critical review of the manuscript.

TRANSPORT MARITIME DU CAFÉ VERT ET CONTENEURISATION

Commandant F. JOUANJAN

Compagnie générale maritime, Paris

Le transport maritime du café vert représente un des maillons de la chaîne des transports depuis les lieux de production jusqu'aux lieux de consommation.

Il faut souligner que les transports, et en particulier le transport maritime, comme les conditions de stockage peuvent être des facteurs extrêmement importants dans le processus de la conservation ou de la détérioration de la qualité du café.

Nous avons pu nous rendre compte que de nombreuses recherches avaient été entreprises aux deux extrémités de cette chaîne, celle qui touche à la production d'une part, et celle qui touche à la consommation d'autre part.

Nous aimerions, dans notre exposé, faire ressortir les récents développements technologiques dans le transport maritime du café vert.

La conteneurisation est, dans ce domaine, l'un des faits dominants de ces dernières années.

I. - LE CONDITIONNEMENT

Le conditionnement du café vert pour son transport maritime n'a guère varié dans le temps puisque transporté au 17^e siècle en sacs, il est toujours transporté, de nos jours au XX^e siècle, en sacs.

Il fut successivement arrimé dans les cales des divers types de navires conventionnels. A bord des voiliers, le café devait supporter la longueur des voyages et les variations des conditions climatiques durant d'interminables traversées. Les cales devaient être complètement fermées pendant des jours et des jours du fait de l'état de la mer ou des mauvaises conditions météorologiques, ce qui provoquait parfois des avaries importantes à la cargaison par fermentation et moisissure. Les cafés et autres marchandises telles que les épices, le rhum, les salaisons, ... étaient souvent arrimés dans une même cale, ce qui entraînait des contaminations de diverses natures.

A bord des cargos à vapeur puis, à moteur, les conditions de transport se sont peu à peu améliorées du fait de l'augmentation de la vitesse des navires et aussi des possibilités de ventilation mécanique des cales.

Il nous semble, cependant, que le transport maritime du café a toujours manqué de recherches fondamentales jusqu'à ces dernières années et, plus particulièrement, jusqu'à l'avènement de la conteneurisation dans les pays producteurs de café.

II. - PROBLEMES POSES PAR LE TRANSPORT MARITIME CONVENTIONNEL

Le transport d'un produit, tel que le café vert, dans les cales des cargos conventionnels peut présenter certains risques de dommages à la cargaison. Est-il nécessaire de mentionner que des contentieux très lourds ont dû être réglés pour des avaries à des lots importants de café ou même à des cargaisons entières.

Ces dommages peuvent se présenter sous diverses formes.

- mouille à la cargaison par suite d'entrée d'eau dans les cales, eau douce ou eau de mer, ou par suite de forte condensation.
- Fermentation et échauffement de la masse des sacs de café chargés dans de mauvaises conditions atmosphériques, pluie ou humidité relative extérieure excessive.
- Décoloration importante des grains de café vert au moins dans les sacs situés en périphérie du chargement en cales, dans les rangées supérieures et dans les sacs arrimés près de la coque du navire, ceci par suite de conditions climatiques hivernales, gel et basses températures extérieures.

Nous citerons aussi diverses contaminations par des produits chimiques ayant été chargés au cours de voyages précédents, pollutions par suite de fuites de combustibles, fuel, huiles, ...

- Contaminations par des produits tels que le sucre ou des graines telles que le ricin, ce qui pose de sérieux problèmes lors de la torréfaction.
- Contaminations par odeurs de diverses natures provenant parfois de marchandises arrimées dans d'autres compartiments que ceux réservés au café.
- Dommages causés par les insectes ou les rongeurs.
- Nous avons aussi été témoins d'avaries par du fardage résineux (planches de bois que l'on place dans le fond des cales pour éviter le contact des sacs avec les tôles). Les sacs, placés sur ce fardage, se déchiraient entièrement lors du déchargement et le café avait aussi l'odeur et le goût de résine.

Ces diverses avaries, qui souvent sont dûes à des accidents ou à des défauts d'arrimage à bord des navires conventionnels, surviennent également parfois dans les entrepôts à terre avant l'embarquement ou après le débarquement du café.

Nous ne nous attarderons pas sur les dommages par contaminations qui peuvent être causés au café par des agents extérieurs, mais nous étudierons les différents facteurs naturels tels que l'humidité, la température, l'aération qui peuvent agir sur les résultats du transport de cette marchandise, et par voie de conséquence sur sa qualité.

Il est certain que le transport par mer d'un produit hygroscopique tel que le café chargé dans les zones intertropicales nécessite une attention toute particulière afin d'éviter les effets de la condensation, la fermentation et moisissures, la décoloration des grains, la perte ou changement d'odeur ou de saveur constaté lors du test à la tasse, une augmentation ou une perte sensible de poids.

Les résultats du transport maritime du café vont dépendre de plusieurs facteurs :

- le type de café,
- l'état du café lors de l'embarquement,
- les zones de trafic,
- les saisons ou les conditions climatiques et atmosphériques.

- LE TYPE DE CAFE -

Nous ne possédons pas de renseignements sur le transport par mer des cafés "Libérica", ni "Arabusta", qui sont à notre connaissance peu exportés.

Le "Robusta", exporté plus particulièrement des pays du continent africain, se transporte sans trop de problèmes, aussi bien à bord des navires conventionnels qu'en conteneurs standard ordinaires.

Nos expériences concernent plus spécialement les cafés "Arabica" qui représentent environ 65 % de la production mondiale et qui sont plus délicats à transporter ; les processus de fermentation, décoloration, changement de saveur peuvent se développer

plus franchement que dans le cas du "Robusta".

Il y a encore lieu de faire une distinction entre les cafés issus de la voie humide et ceux issus de la voie sèche, les cafés de la "voie humide" étant plus sensibles que ceux de la "voie sèche".

- L'ETAT DU CAFE LORS DE L'EMBARQUEMENT -

Nous serions tentés d'affirmer que le café sera dans la plupart des cas transporté dans de bonnes ou mauvaises conditions selon son état à l'embarquement. Nous sommes personnellement persuadés que c'est le point le plus important sur lequel il y a lieu d'insister.

Le café à l'exportation se trouve normalement dans les conditions dites du "café marchand", c'est-à-dire qu'il doit correspondre à des normes admises. Nous pouvons pourtant nous poser la question de savoir si ces normes de "café marchand" vérifiées dans la zone de production ne se trouvent pas modifiées à la suite du transport au port d'embarquement.

Un exemple : un lot de café entreposé dans un centre de conditionnement à l'intérieur d'un pays possède une teneur en eau de 12 % avec une humidité relative extérieure de 70 % et une température de 20° ; lorsque ce café sera transporté de ce centre au port de chargement, l'humidité relative peut atteindre la saturation 90 ou 100 % et la température extérieure peut s'élever à + de 30°. Ces nouvelles conditions changent de façon très sensible les données du problème et posent de façon toute différente le problème de la conservation au cours du transport par mer.

En effet, l'interaction de la température extérieure, de l'humidité relative extérieure sur le pourcentage en eau du café est importante pour l'activité biologique du café vert.

- LES ZONES DE TRAFIC -

Le transport par mer du café se faisant à partir des zones tropicales, notamment vers l'Europe, l'Amérique du Nord, le Japon, la notion de durée de voyage doit être prise en considération. Il est évident que les risques sont peu importants si la durée du transport est courte, le processus de détérioration de la masse étant assez lent. Si la durée du transport est longue, il y a évidemment davantage de risques.

- LES SAISONS ET LES CONDITIONS CLIMATIQUES -

Le passage de températures tropicales à des températures basses, en particulier durant l'hiver, pose le problème de l'accélération de la migration de l'humidité au sein de la cargaison, vers la périphérie et l'extérieur, d'où des risques de condensation et de concentration d'humidité.

III. - LA CONTENEURISATION

De nos jours, la conteneurisation est devenue un phénomène irréversible pour les échanges maritimes internationaux, non seulement pour les produits transformés de consommation courante, les produits manufacturés ou industriels, mais de plus en plus pour une part importante des produits du secteur primaire et, en particulier, les produits tropicaux au nombre desquels nous citerons évidemment le café.

Le conteneur maritime, qui a commencé à déferler sur le monde il y a une quinzaine d'années, peut être considéré comme une étape et même une révolution ouvrant une ère nouvelle dans le transport maritime. Les navires se sont transformés, les ports ont dû changer leur infrastructure et leur équipement, le travail des entreprises et des ouvriers portuaires a été profondément modifié.

Le conteneur maritime s'est peu à peu standardisé aux normes I.S.O. et si le module de 35 pieds existe encore, le module de base est devenu le conteneur de 20' avec un multiple, le conteneur de 40'.

Le transport de ces conteneurs est effectué par des navires spécialisés de plus en plus grands, puisque ceux dits de la troisième génération peuvent transporter plus de 3 000 conteneurs équivalents 20' et que le chiffre de 4 000 conteneurs est déjà avancé pour certains projets en cours d'études.

Pour les navires porte-conteneurs, les objectifs recherchés sont surtout la diminution de la durée du séjour dans les ports d'escale par l'augmentation du rendement de la manutention des marchandises ainsi qu'une protection plus efficace de ces marchandises.

Il est évident que le but de la conteneurisation est la suppression des ruptures de charge dans la chaîne de transport. Un conteneur empoté par un client chargeur à l'exportation devrait parvenir dans le même état chez le client réceptionnaire à l'importation.

L'évolution de la conteneurisation maritime dans le monde tient en quelques chiffres statistiques du parc mondial des conteneurs :

- En 1972 = 885.000 équivalents 20'
- En 1978 = 2.119.000 équivalents 20'
- En 1980 = 2.990.000 équivalents 20'

soit une augmentation de 238 % en 8 ans et une augmentation annuelle moyenne de près de 30 % du nombre des conteneurs maritimes dans le monde.

Ce résultat montre que la conteneurisation gagne peu à peu l'ensemble des continents et l'ensemble des pays.

Lorsqu'il est apparu, le conteneur n'a pas reçu de la part des exportateurs de café, ni des réceptionnaires, l'accueil qui aurait dû lui être réservé. Il est vrai que cette boîte un peu

mystérieuse pour beaucoup vient changer aussi de vieilles habitudes séculaires.

Subitement on nous a laissé entendre qu'il n'y avait rien de mieux que le service des navires conventionnels et que le conteneur n'était qu'une source de calamités et, en particulier, source d'avaries de toutes natures pour le café.

Aujourd'hui, en 1980, nous sommes en mesure d'affirmer que ces craintes n'étaient pas fondées puisque les cafés et, en outre, les "Arabica" se transportent régulièrement en conteneurs et sans nul doute dans de meilleures conditions que dans le système conventionnel.

Nous passerons sans tarder davantage à la synthèse des résultats des essais et tests réalisés sur les "Arabica" et en particulier nous tenterons de faire le point des connaissances actuelles en matière de transport de café en conteneurs, en nous basant sur l'expérience que nous avons acquise dans ce domaine durant ces cinq dernières années.

IV. - LES ESSAIS ET LES TESTS

En 1975, nous commençâmes à procéder à des essais de transport. A peu près tous les types de conteneurs furent utilisés et des tests simultanés et comparatifs furent effectués en toutes saisons entre divers types de conteneurs et des cargaisons conventionnelles sur divers navires. Des conteneurs standard furent transformés, adaptés ou construits spécialement comme prototypes. Certains conteneurs furent équipés d'appareils deshumidificateurs électriques, des essais de transport avec silicagel furent réalisés, des appareils de mesures enregistreurs : thermomètres, hygromètres, furent ajoutés à l'intérieur des conteneurs, les conditions météorologiques et climatiques extérieures furent régulièrement relevées tant à la mer que dans les ports d'embarquement et de débarquement, des conteneurs furent transportés aussi bien sur le pont des navires que dans les cales, des conteneurs furent embarqués avec les portes entr'ouvertes ou complètement fermées, les essais furent entrepris sur des cafés Arabica de plusieurs provenances : de Colombie, Haïti, Costa Rica, Honduras et Guatemala à destination des ports Européens. Des échantillons de café furent pris au port d'embarquement et transportés aux ports de destination afin de pouvoir comparer les qualités respectives du café en conteneurs et celui des échantillons. Des experts furent désignés pour le contrôle avant chacune des livraisons de conteneurs dans les ports européens.

V. - LA SYNTHÈSE DES RESULTATS

Il était évidemment difficile de parvenir à des conclusions définitives à l'issue de ces essais, mais des résultats importants ont pu être obtenus pour faire progresser cette technique nouvelle de transport. Nous les avons rassemblés et en avons réalisé la synthèse :

- Les principaux risques d'avaries au café transporté en conteneurs

résident dans le fait que le café est une marchandise de nature hygroscopique et qu'il contient un certain pourcentage normal d'eau, environ 12 %. Une modification sensible de cette teneur normale en eau peut entraîner des avaries : décolorations, fermentations ...

- Une masse de café est influencée par la masse d'air qui l'entoure et, en particulier, par l'humidité relative de cette masse d'air.
- Il existe une situation d'équilibre et une corrélation entre les trois facteurs : humidité relative - température ambiante - et la teneur en eau du café.

- L'activité biologique du café vert est relativement réduite, la quantité d'oxygène consommée étant faible et sensiblement égale à la quantité de CO₂ émise. Pour assurer la respiration normale du café il n'est donc pas nécessaire de procéder à une ventilation forcée mais tout simplement à une aération normale (volume d'air suffisant).

- Les échanges thermiques au sein d'une masse de café se font par convection et par conduction. L'échange par convection est un phénomène plutôt rapide et qui peut être soit accéléré ou ralenti par la modification du gradient de température ou par action mécanique sur les filets d'air (brassage).

L'échange par conduction est relativement lent, ce qui signifie que le café par lui-même est un assez bon isolant - nous avons pu le vérifier au cours d'un transport de café en vrac en conteneur.

- La migration de la vapeur d'eau se fait également par convection et par diffusion.

Alors que la diffusion est relativement lente, la convection suit le même mécanisme que dans le cas des échanges thermiques par convection. C'est un processus rapide, qui peut être accéléré ou ralenti. On constate toutefois que l'accélération des échanges thermiques par brassage ralentit la migration de la vapeur d'eau par convection.

- Le phénomène de la condensation se produira à l'intérieur du conteneur si la température de l'air ambiant est inférieure à la température du point de rosée. L'eau de condensation se déposera sur les parois les plus froides du conteneur, parois métalliques, ponts thermiques ... on voit immédiatement la nécessité d'une construction spéciale du conteneur afin d'éviter la mouille du café par les effets de condensation lorsque celle-ci se produit.

- D'autre part, il faut souligner que les cales d'un navire et, en particulier, celles d'un navire porte-conteneurs, où les conteneurs forment des séries de cloisons intermédiaires, assurent à la marchandise une bonne protection contre les effets des variations de températures extérieures de l'atmosphère, ensoleillement, gel, ... et aussi contre les effets immédiats des variations de l'humidité relative de l'air extérieur. Chaque conteneur crée,

en effet, son propre micro-climat et c'est ce micro-climat qu'il importe de réguler de manière à maintenir les conditions d'une bonne conservation.

- Les essais ont confirmé que le processus de fermentation et de formation de moisissures ne se développait pratiquement pas dans un conteneur de 20' standard fermé et sans ouvertures, chargé d'un lot de café de 250 sacs lorsque l'empotage du conteneur avait été réalisé dans les conditions suivantes :

- . Humidité relative de l'air ambiant inférieure à 75 %,
- . Teneur en eau des grains aux environs de 12 %,
- . Température extérieure : 27 à 30° C.

VI. - LES MESURES GENERALES A PRENDRE POUR EVITER LES AVARIES

Compte tenu de la situation actuelle, où l'empotage des conteneurs se fait dans la majeure partie des cas au port de chargement, quelques règles simples de prévention des avaries peuvent être édictées :

Nous supposons que le café livré aura une teneur normale en eau et qu'il n'existera avant empotage aucune décoloration des grains, ni aucun foyer latent d'humidité ou de moisissure sur les sacs, ni dans la masse du café. Nous supposons aussi que les conteneurs sont des conteneurs standard en acier ou en G.R.P. (c'est-à-dire en contreplaqué revêtu de polyester).

- L'humidité relative extérieure au moment de l'empotage ayant une très grande importance, il est nécessaire de procéder à l'empotage en des endroits où l'humidité relative soit le moins élevé possible, hangars protégés ... L'idéal étant de parvenir à environ 70 % d'humidité relative par un minimum de conditionnement de l'air ambiant.
- Lorsque l'humidité relative au moment de l'empotage est supérieure à 75 % et inférieure à 80 %, il nous paraît nécessaire soit de réduire le nombre des sacs dans le conteneur afin d'augmenter le volume d'air libre au dessus du volume occupé par la masse du café, soit de remplir le conteneur normalement et de mettre l'intérieur du conteneur en communication avec l'extérieur, c'est-à-dire avec la cale du navire, la porte du conteneur demeurant entr'ouverte, ou bien d'utiliser un conteneur aéré.
- Lorsque l'humidité relative au moment de l'empotage est supérieure à 80 %, la réduction du nombre de sacs ne nous semble pas suffisante et il est nécessaire d'établir une communication entre l'intérieur du conteneur et la cale du navire afin de chercher à réduire et maintenir l'humidité relative de l'air ambiant conteneur/cale à un taux inférieur à 70 % par les effets de convection ou par brassage mécanique de l'air ambiant.
- L'ouverture des portes d'un conteneur dans une cellule de navire porte-conteneurs pose de sérieux problèmes opérationnels et c'est pour cela que l'utilisation de conteneurs spéciaux aérés est très souhaitable.

Lorsque le gradient de température entre l'intérieur du conteneur et l'extérieur augmente, il peut exister des risques de condensation dans le conteneur si la température ambiante est inférieure à la température du point de rosée. Il nous paraît alors nécessaire de prévoir l'utilisation de conteneurs spéciaux et adaptés qui permettent d'éviter les effets de la condensation sur la masse de la marchandise.

Cette dernière situation peut se présenter en particulier après le débarquement du conteneur s'il demeure durant la saison hivernale plusieurs jours sur un quai, exposé à des conditions climatiques défavorables (basses températures). Elle peut se présenter également au cours des transports intérieurs sur camion, wagon ou barge en hiver.

VII. - LA PRESENTE SITUATION DU TRANSPORT DU CAFE VERT EN CONTENEURS

Le café vert étant conditionné en général en sacs de jute de 60 à 70 kilos, il est possible d'arrimer dans un conteneur standard de 20' entre 200 sacs de 70 kilos dans le cas de café à gros grains et 250 sacs de 70 kilos dans le cas de café à grain moyen, en tenant compte d'une lame d'air minimum qui doit être maintenue dans la partie haute du conteneur. Ces quantités correspondent par conséquent à un tonnage moyen compris entre 14 et 17,5 tonnes.

- A l'exportation, les sacs de café sont transportés depuis les lieux de production ou depuis les entrepôts intérieurs jusqu'au port par la voie routière ou ferroviaire. Les conteneurs sont ensuite empotés soit sous des hangars portuaires ou à l'extérieur de ces hangars, ou bien directement depuis les camions ou wagons. Nous donnons cette précision pour faire remarquer que dans la plupart des cas, les sacs de café, au moment de l'empotage, sont en réalité et très souvent soumis à l'influence directe des conditions climatiques extérieures.
- A l'importation, après le débarquement des conteneurs, ceux-ci sont soit dépotés dans la zone portuaire ou transportés directement chez le réceptionnaire.

VIII - LE TYPE DE CONTENEURS

Les conteneurs standard dits "Secs" sont en général soit en acier ou en aluminium ou en G.R.P.

Dans le cadre des transports de café, on a souvent voulu faire le procès de l'un ou l'autre des types de conteneurs secs. Nous avons exposé précédemment les résultats d'expériences qui montrent que les risques d'avaries par moisissures et condensation dans un conteneur fermé dépendent surtout du pourcentage d'humidité relative de l'air ambiant, au moment de l'empotage. Nous ne voulons pas amplifier cette mauvaise querelle, mais nous voulons cependant préciser que si l'on veut comparer ces deux types de conteneurs, il faut aussi comparer des résultats dans des situations identiques.

Cela a bien sûr été réalisé mais nous éviterons de donner l'avantage à l'un d'eux. Le coefficient K (coefficient de déperdition de chaleur d'une paroi) est évidemment supérieur dans un conteneur en acier, ce qui signifie que le G.R.P. est un meilleur isolant. On pourrait alors penser simplement que le conteneur G.R.P. est supérieur au conteneur acier.

Interviennent alors, d'une part, les effets des ponts thermiques formés par le cadre en acier d'un conteneur en G.R.P. En cas de condensation, il y aura sur ce cadre une très grande concentration de l'humidité alors que dans un conteneur en acier cette humidité sera répartie sur une plus grande surface.

D'autre part, il y aura dans le conteneur en acier des échanges thermiques plus rapides par convection et, par conséquent, une répartition plus homogène de la vapeur d'eau entre la masse du café et la lame d'air maintenue dans la partie haute du conteneur.

Nous allons dire quelques mots des résultats de deux expériences qui ont été réalisées :

- La première consistait en l'utilisation d'un appareil deshumidificateur électrique adapté à des conteneurs transportant du café. Les résultats n'ont pas été satisfaisants. Cet appareil crée à l'intérieur du conteneur un micro-climat supplémentaire dans la zone proche de l'appareil et nous avons pu constater que les grains de café situés dans cette zone étaient souvent décolorés.

D'autre part, cet appareil coûteux est difficilement exploitable sur le plan opérationnel. Il transforme une simple boîte en un équipement sophistiqué et fragile qui entraînerait la nécessité d'une alimentation électrique supplémentaire et aussi la nécessité d'un télécontrôle de fonctionnement.

Cette idée a été abandonnée.

- La deuxième expérience consistait en l'utilisation de produits absorbants tels que le silicagel. Ces produits ne donnent de résultats sensibles que s'ils sont utilisés en grandes quantités. C'est alors une opération également coûteuse et qui nécessite de multiples interventions au niveau de l'approvisionnement et de la distribution.

IX. - LE SYSTEME PASSIF

Devant la nécessité de trouver une solution sûre au transport des cafés en conteneurs et compte tenu des résultats obtenus lors des tests et essais réalisés, nous avons étudié et mis au point un nouveau conteneur qui tient compte des quatre objectifs de base que nous nous étions fixés. Ces quatre objectifs de base étaient les suivants :

a) Etant donné que les risques de condensation existent dans un conteneur fermé lorsque l'humidité relative est importante

au moment de l'emportage et lorsque la température extérieure baisse sensiblement au cours du transport maritime ou terrestre à destination, il est nécessaire de protéger la marchandise contre les effets de cette condensation et de diriger/contrôler cette condensation.

b) Il est nécessaire de mettre le conteneur en communication avec l'extérieur et de l'aérer afin de permettre une extension de la lame d'air de la partie supérieure du conteneur et de permettre également un brassage intérieur lorsque la ventilation mécanique des cales du navire porte-conteneurs est mise en marche.

c) Ce conteneur devait pouvoir transporter aussi bien des marchandises diverses que des marchandises telles que le café afin de pouvoir être utilisé de façon permanente et rationnelle.

d) Il devait avoir un prix peut différent de celui d'un conteneur standard ordinaire et un volume intérieur comparable.

Nous avons été satisfaits d'avoir pu concevoir et réaliser un conteneur répondant à ces impératifs.

Nous n'allons pas entrer dans les détails de construction de cet équipement. Nous nous bornerons seulement à vous indiquer qu'il permet d'éviter les effets des variations thermiques excessives et ainsi de diminuer la formation de la condensation. Il est équipé d'aérateurs qui laissent circuler l'air mais empêchent les entrées d'eau de pluie et de mer. En cas de condensation, celle-ci est drainée vers deux zones latérales qui ont été conçues pour servir de pièges à humidité. Ainsi, la marchandise se trouve-t-elle, à l'intérieur du conteneur, hors de contact avec l'eau de condensation et donc protégée. Ce procédé est aujourd'hui connu sous le nom de "Système passif" qui tend à se répandre.

X. - LES ASPECTS POSITIFS DE LA CONTENEURISATION DES CAFES COMPAREE AU SYSTEME CONVENTIONNEL

Nous avons déjà souligné que le café pouvait désormais être transporté en conteneurs dans de bonnes conditions et la comparaison avec le transport conventionnel peut d'ores et déjà se faire.

- Les avaries par mouille, fermentation, pertes de poids sont inférieures dans le transport en conteneurs.
- Les avaries par perte du contenu, déchirures de sacs sont moindres dans le transport en conteneurs.
- Les avaries par contaminations sont moindres également dans le transport en conteneurs.

XI. - ESSAI DE PROSPECTIVE - LE CONDITIONNEMENT FUTUR

Il y a deux ans, devant un autre auditoire, nous avons annoncé la possibilité offerte par le conteneur de transporter le café en vrac depuis les lieux de production, supprimant ainsi le sac de jute -avec ses inconvénients physiques et son prix-.

Depuis cette époque, nous avons pu constater un début d'évolution dans ce sens et il est vraisemblable que l'utilisation de cette formule ira en s'amplifiant.

Cela semble illustrer un revirement d'opinion et une prise de position nouvelle capable d'entraîner de profonds changements dans une situation bien établie et c'est pour terminer, l'idée que nous livrons à votre réflexion.

*

*

*

STORAGE RESEARCH ON KENYA ARABICA COFFEE



H. STIRLING, NDAgrE TEng (CEI) MIAgrE

National Research Development Corporation,

Kingsgate House, 66/74, Victoria Street,

London, SW1E 6SL

Introduction

With supply and demand seldom in balance, the world's producers often have to hold their coffee in store for longer periods to keep the prices stable. This can create further problems, because poorly warehoused stocks deteriorate dramatically - and bad beans are unsaleable at any price.

If, however, the factors which contribute to the deterioration in quality can be identified, then they can probably be controlled.

It has long been suspected that high storage temperatures and bean moisture contents or ambient humidities have been the major factors influencing quality loss in stored coffee. This paper describes investigations carried out in Kenya to try and substantiate this, and to discover more precisely the actual rates at which this deterioration would take place under different sets of climatic conditions.

Experimental Trials

The first set of trials involved storing parchment coffee in small silos under sealed conditions at five different temperatures ranging from 10 degrees centigrade up to 35 degrees centigrade, and four different moisture contents, ranging from 8.5%MC to 15.5%MC - which is normally considered to be over-dried to very underdried (Fig. 1). These moisture contents are approximately in equilibrium with ambient relative humidities ranging from 47% RH to 80% RH. At monthly intervals, for a total of 12 months, samples were withdrawn and assessed for quality. This was carried out by two independent liquoring departments tasting 'blind', examining the three constituents of what the Kenya coffee industry understands by quality, namely the raw appearance, roast appearance, and liquor.

These results are shown graphically in Figure 2, the quality being represented on a scale 2-10 (best to worst), with a Reject Class being given a nominal value of 12. These graphs demonstrate very clearly the influence of temperature and moisture on deterioration. For example, on

Graph I it can be seen that damp coffee stored at 30 degrees centigrade to 35 degrees centigrade will reach a state of rejection after 3 to 5 months. Dry coffee at 10.8% MC (Graph III) stored at 35 degrees centigrade will be rejected after 8 months. On the other hand, even the dampest of the coffees managed to retain their quality at the coldest temperature of 10 degrees centigrade. The hottest sample of the driest coffee (Graph IV) lost only two standards in 12 months. Hence it can be seen that, for quality to be preserved, coffee must be kept cool and dry.

The second set of trials compared the differences between parchment coffee, pre-hulled (without the parchment) and clean (without the parchment and the silverskin). It also examined the effects of ventilating coffee in store. The same temperature ranges as before were used, but all the samples were well dried to about 10.4%MC. (This is considered to be the correct storage moisture content in Kenya; coffee above 11.0% is not accepted by the mills). This moisture content is in equilibrium with air at a relative humidity of about 60% RH (see Figure 3). Consequently, the ventilated coffee samples were aerated with air at a constant humidity of 60% RH - this was done continuously throughout the 12-month trial. The same liquoring procedure as before was carried out.

The results are presented in Figure 4. On comparing these graphs, it can be seen that there is little difference between parchment and clean coffees under ventilated conditions. Equally, there is no difference between the storability of pre-hulled and clean coffee under sealed conditions. Ventilation at appropriate humidities does not cause any form of coffee to deteriorate faster than under sealed conditions, indeed at warmer temperatures it definitely helps quality preservation.

Characteristics of Quality Loss

From both these trials, various characteristics associated with quality loss have emerged from the liquorers' reports. These can be summarised as follows:-

RAW: The colour changed from greyish blue through to brown and then faded. In extreme cases, the raw beans smelled foul and musty, and even had an odour of rotting pulp.

ROAST: The colour changed from bright to dull brownish, centre cuts tended to open and a noticeable proportion of beans became soft and pale.

LIQUOR: The acidity changed from medium to light. The body changed from medium to full. The flavour acquired a taint, initially detected as slightly sourish, but soon became musty and woody, progressing eventually to foulness and rejection.

In addition, it can be stated with certainty that the single most important factor associated with storage deterioration which is detectable in the cup liquor is woodiness. However, the presence of a slight taint - although recorded by a liquorer - does not always affect the classification number, particularly in cases where the coffee has a good raw and roast appearance. Consequently, Figures 2 and 4 do not necessarily truly represent lines at the better classification in which the cups were completely taint-free.

This is rather an important aspect. On close examination of all the liquorers' reports for all the trials, it was found that parchment coffee showed less of a tendency to develop woodiness than pre-hulled or clean coffees. Pre-hulled, in turn, appeared slightly less susceptible than clean coffee. It is not considered that ventilation on its own helps to reduce the incidence of woodiness, but it can be concluded that parchment coffee, under cool, dry, ventilated conditions, will retain its initial quality for at least 12 months with negligible woody off-flavours appearing in the cup.

Initial Conclusions

What are the practical conclusions to be drawn from these findings? Most coffee producing regions are in the high altitude tropics and although these regions tend to have cold night temperatures, they also generally have high maximum day temperatures, frequently with distinct rainy seasons giving sustained periods of high humidity. Consequently, coffee left in conditions like these for any length of time can be expected to deteriorate unless the storage environment is modified in some way.

In addition, all coffee for export markets will spend some part of its life in sea-level depots at ports, with high temperatures and extreme humidities for most parts of the year. These adverse conditions are also likely to prevail in the holds of freighters during shipment to the ultimate destination.

When a parcel of good quality Arabica coffee from, say, East Africa or South America is air-freighted to Europe immediately after processing and milling, and compared with an identical parcel which has been sent through the normal export channels involving storage and shipment, buyers in most cases recognise that a quality loss has taken place in the sample sent by sea.

Bag Storage Bag stores in Kenya are typical of tropical warehouses found in many countries, having an open eaves space and an open ridge vent running the full length of the building, as in Figure 5 (I). Trials were carried out to measure the effectiveness of this design in modifying the environment and from the data obtained it would appear that the conventional, naturally-ventilated warehouse does little or nothing to improve the internal storage environment. Store temperatures overall were little different from external ambient maximums and minimums, and because the ventilation spaces are permanently open, humidities fluctuated widely in accordance with the normal diurnal variations. During rainy seasons, the store micro-climates were very humid for considerable periods of time. Any hygroscopic commodity will tend to absorb and desorb moisture in response to a fluctuating humidity and - in the case of coffee - this constant swelling and contracting contributes towards quality loss.

Scale Model Warehouses

Scale model warehouses were built to see if it was possible to improve on this conventional design. The most successful of these models is shown in Figure 5 (II). It was found that:-

1. The installation of a double skin reflective roof, with a freely ventilated air-space between the layers reduced the internal store temperature.
2. Solar heating is further reduced by having generous roof overhangs to shade the walls, and by painting all external surfaces receiving direct sunlight in glossy white.
3. Controlling the ventilation in the main part of the store by means of electric fans operating automatically on a control circuit is very effective, since not only does it provide some cooling it very considerably evens out the wide humidity fluctuations.

Bulk Storage

Although bulk storage in silos is not currently practised in Kenya, the Kenya coffee industry felt that the method should be investigated. A 3.5 tonne experimental silo was built in the coffee mills, incorporating fan ventilation with a method of automatic control.

This selects suitable conditions of ambient air at any time of day or night. It was found that:-

Coffee can be successfully stored in a ventilated silo with minimum quality loss.

The control system is an effective method of cooling coffee in a silo and maintaining it under cool, dry conditions in the non-humid tropics.

It is a practical system to install on a large scale and is likely to produce a better storage environment than a bag store with a similar ventilation system.

Both galvanized steel and aluminium are suitable silo materials, neither causing any tainting. They are preferable to timber which, should it become damp, will encourage bacterial growth which can easily be transmitted to the coffee.

Automatic Ventilation System

As I have mentioned, the use of unmodified air for the ventilation of coffee would result in a most unfavourable storage environment; this can be overcome with an automatic control system operating as follows:-

Two temperature sensors (thermistors) are used, one placed in a meteorological screen situated outside the building and the second bedded into the bulk of the coffee in the silo or store. The fan will operate only when the outside sensor is colder than the internal one, the temperature difference required being 0.5 degrees centigrade. This, therefore, is the basic cooling process.

Next, the circuit is over-ridden by two humidistats, set at 50% and 70% respectively, to ensure that only air within that range is blown.

This is suitable for controlled ventilation of both bag stores and silos, and the respective applications are shown in Figures 6 and 7. It must be pointed out that it has been developed for what is essentially a non-humid tropical region, and for installations in more humid climates partial air-conditioning would be needed to boost the system. For the equipment to work satisfactorily, the average number of hours of ventilation per day should be between 4 and 6.

It is a simple matter to analyse local meteorological data for any given region, to estimate approximately whether the prevailing temperature and humidity patterns will provide this number of hours. In Kenya, the general trend is about 1.5 hours in the morning and 3.5 in the evening.

The theory that stores should only be ventilated with cool, dry air at appropriate times of the day or night and remain sealed during hot periods, relying on the insulation properties of the roof and the residual coolness of the fabric and the stored commodity to limit the heat gain before the next ventilation period, would seem to be very valid. But it is a departure from traditional thinking which generally favours ventilation during the hot periods of the day. It is suggested that this latter approach serves little useful purpose, since it merely increases the overall heat gain of the structure and its contents.

Summary of Essential Principles

To summarise, it should be recognised that in order to preserve the initial high quality of Arabica coffee during extended storage periods,

the following essential principles must be observed:-

1. The beans must be kept cool.
2. After being initially well dried, they must also subsequently be kept in a dry environment.
3. Constant conditions of temperature and humidity are believed to be more beneficial than widely fluctuating ones.
4. As a general rule, controlled ventilated conditions are more beneficial than sealed storage conditions, especially at higher temperatures.
5. Parchment coffee stores better than pre-hulled and clean coffees.
6. Pre-hulled coffee probably stores slightly better than clean coffee.
7. Storage temperatures should be maintained at less than 20 degrees centigrade, and at the same time humidities should be kept within the range of 50% - 70% RH.
8. Under these conditions, parchment coffee can retain its initial quality for at least 12 months.
9. Good initial storage conditions probably help to minimize subsequent deterioration when the coffee is moved into an unfavourable environment: for example, during shipment for export.
10. In the non-humid tropics, suitable environments can be inexpensively achieved in bag and bulk stores using fan ventilation controlled automatically by a system such as the one described. Thermal insulation of the structure is also very important.
11. Storage for any length of time in humid tropical areas such as port depots would justify the expense of using air-conditioning.

"Follow Up"

These conclusions were arrived at in early 1975, and by late 1976 the Kenya Planters' Cooperative Union had signed a £1.5 Million contract for a new clean coffee warehouse adjacent to the Nairobi Coffee Mills. This was commissioned in early 1979 and has a storage capacity of 12,000 tonnes on 7 floors.

A further £1 Million has been spent on equipment to improve quality, such as electronic sorters and gravity separators. This has resulted in improvements in quality to the growers of between £50 and £200 per tonne.

That is, a capital investment of some £3 Million has resulted in an average increase in value in excess of £100 per tonne, on a crop of 70,000 tonnes per annum.

The building has been designed to combat deterioration in coffee, and features a double skin external wall construction of light and heat reflecting precast concrete units to minimise the temperature fluctuations in the warehouse.

The design allows flexibility, in that although silos and automatic ventilation have not as yet been incorporated, they easily could be at a future date. The main reason for omitting them at present is that the Kenya coffee crop has not expanded as much as was expected in 1975; indeed in the last two years, it has been small, and this,

together with market conditions, has resulted in minimal storage periods.

It is however interesting to note that the K.P.C.U., a strictly commercial organisation, has invested considerable funds in following up research findings based on data from laboratory, model and other trials, for the ultimate benefit of its members - the growers.

Figure 1

MINIATURE TEST SILO (AIRTIGHT)

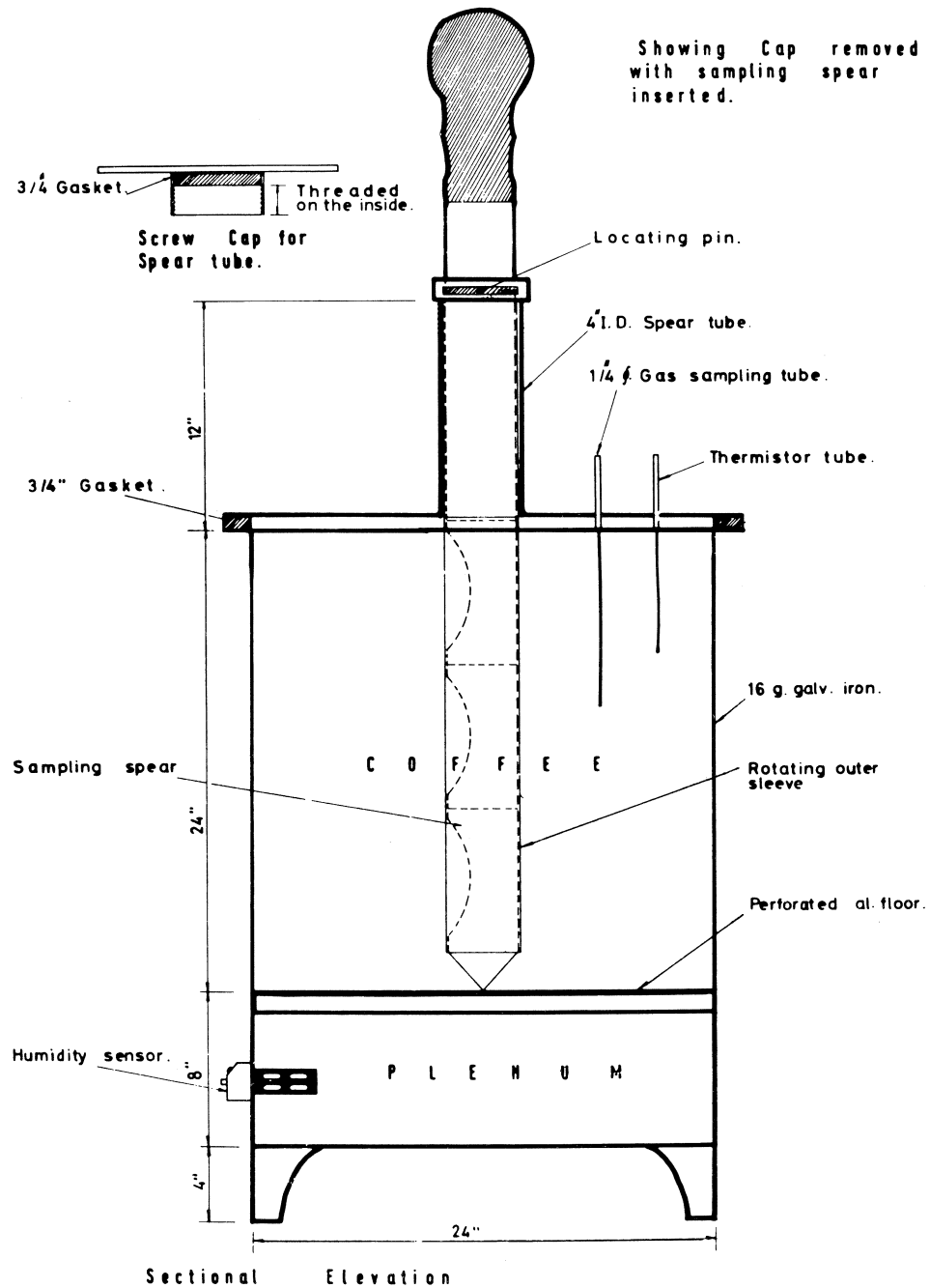

Figure 2

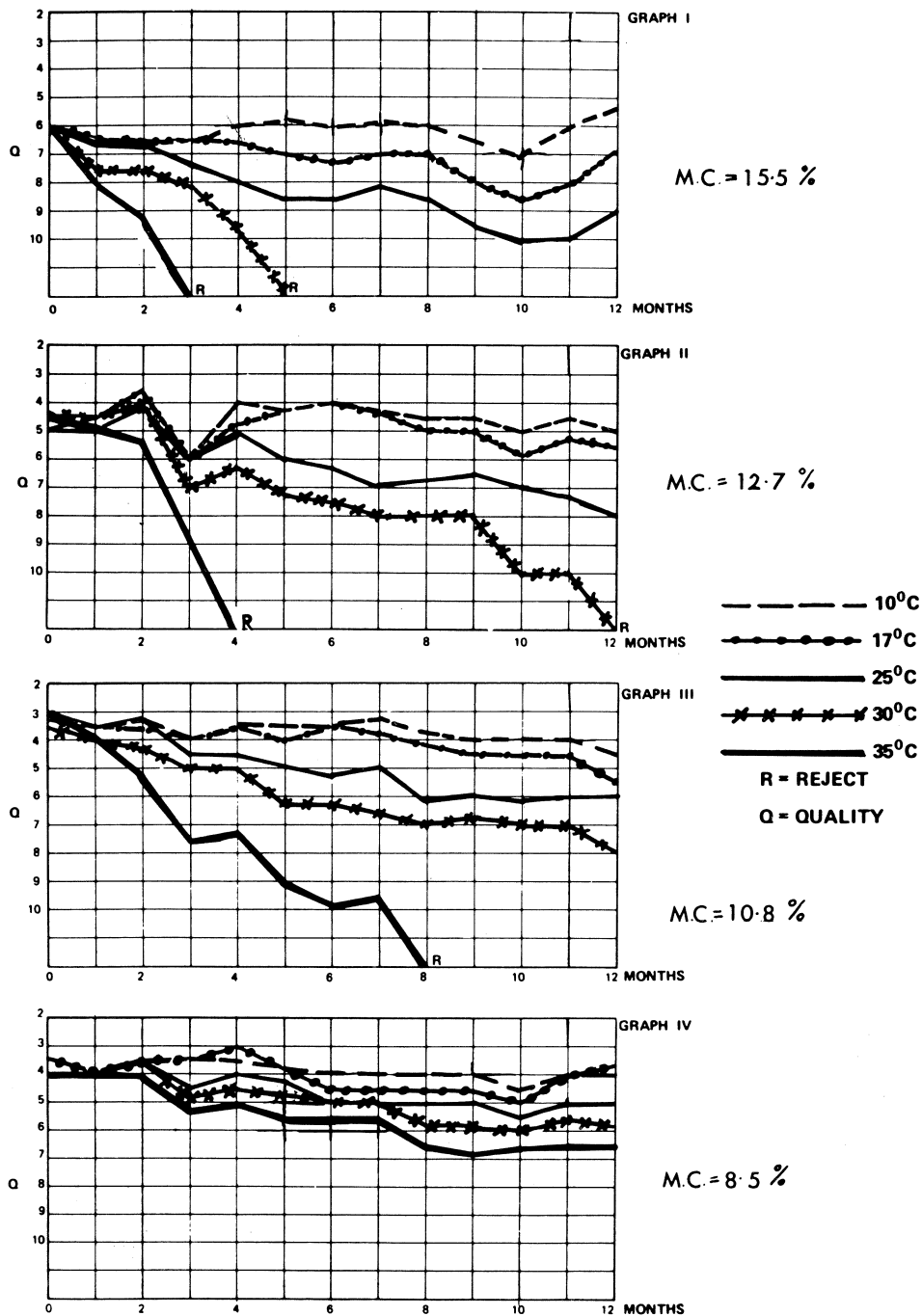

Figure 3

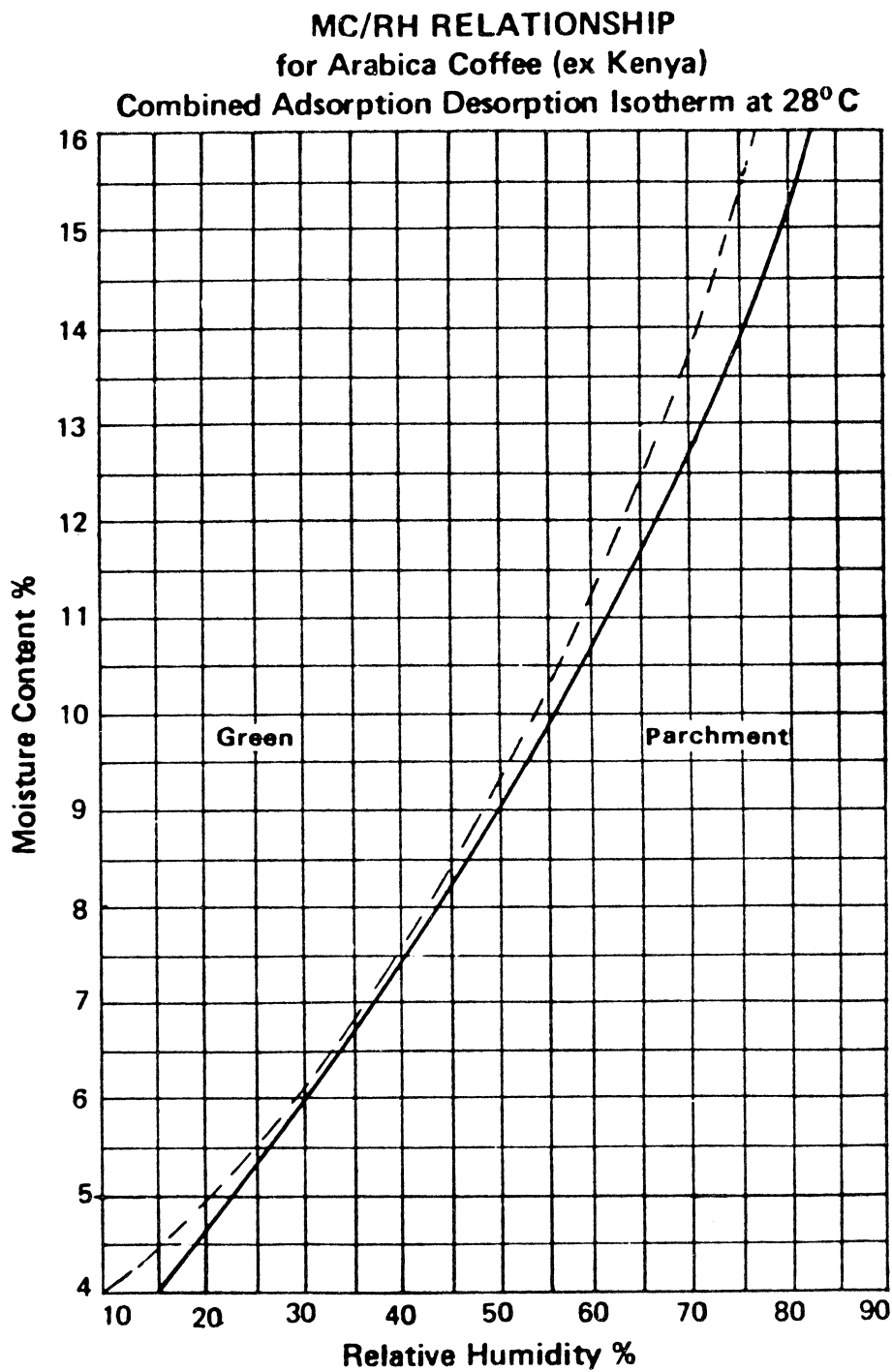

Figure 4

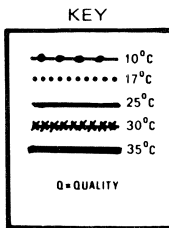
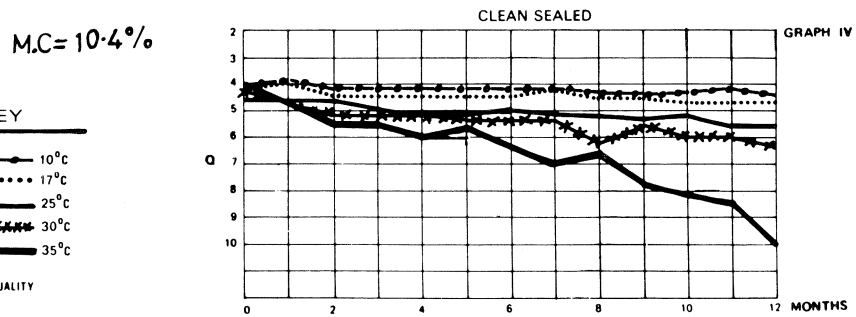
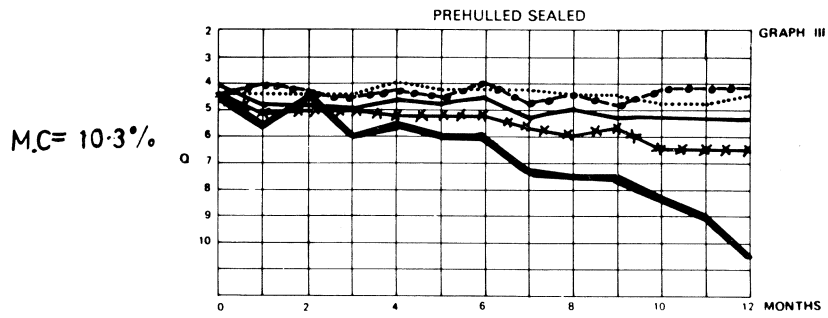
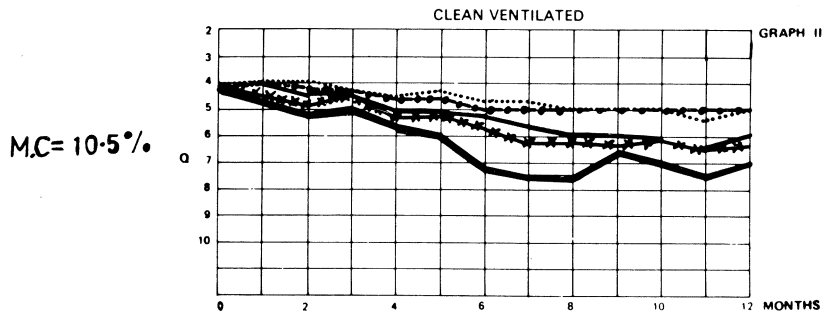
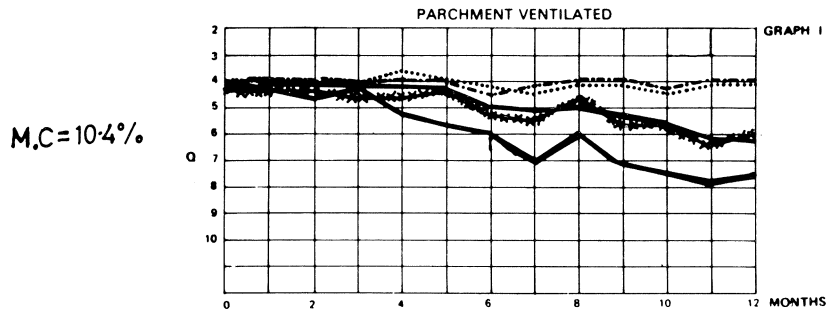

Figure 5

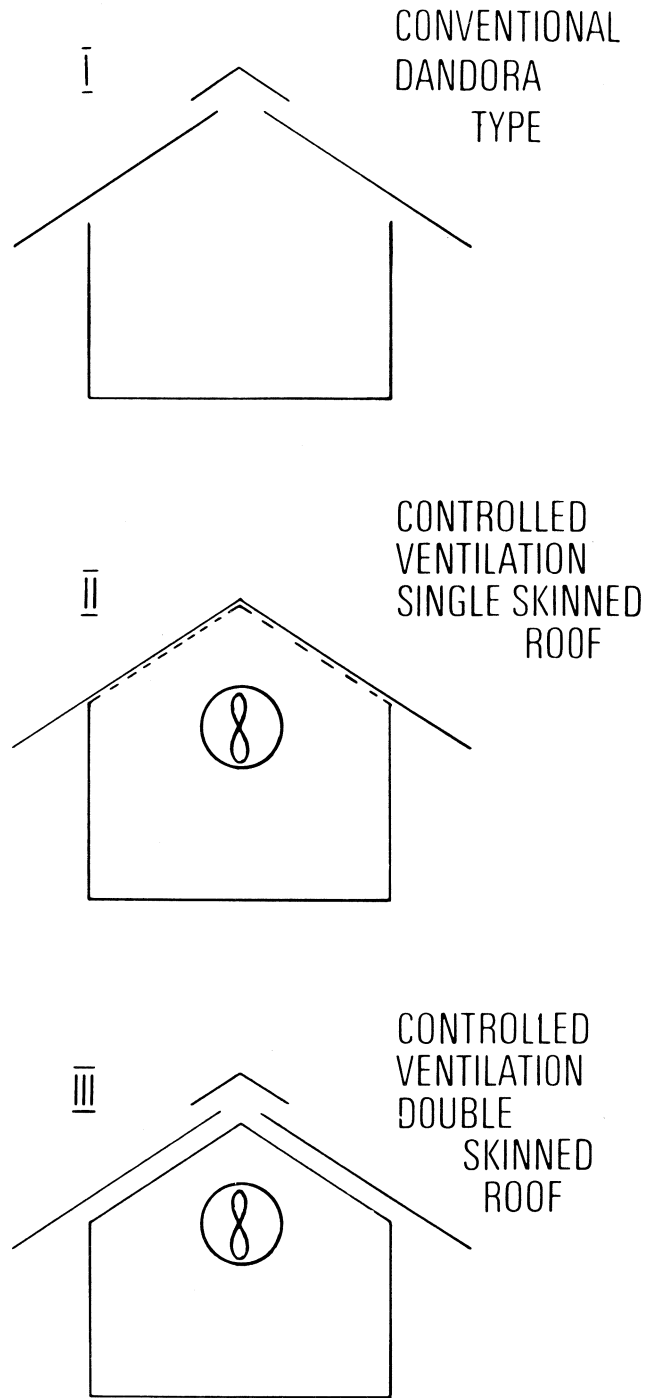

DIAGRAM OF DANDORA MODIFICATION

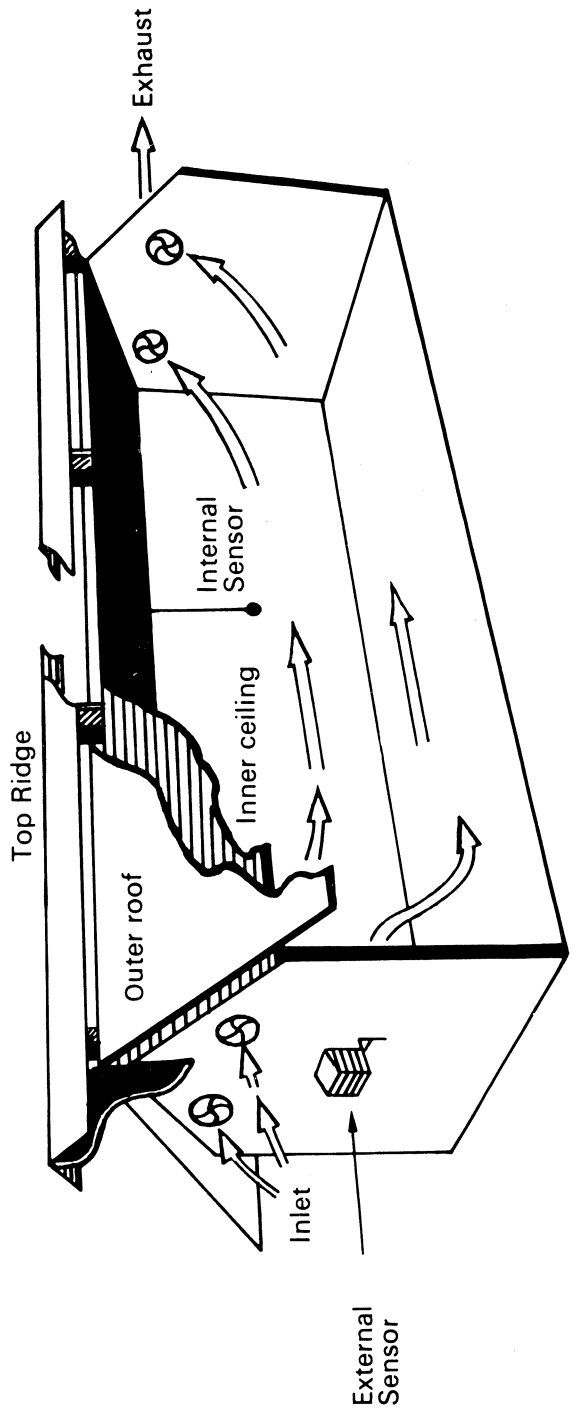
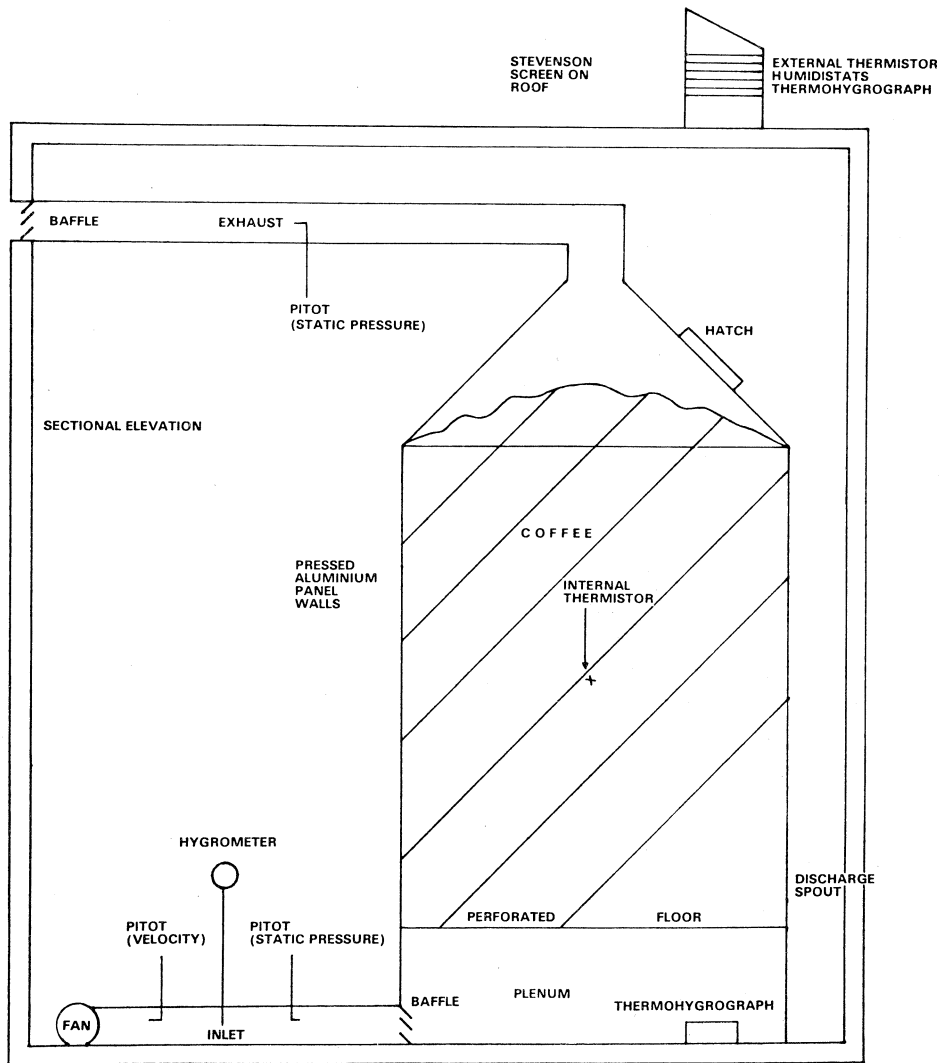

Figure 6

Figure 7

THE SILO DESIGN



INSTRUMENTATION SYSTEM FOR THE ANALYSIS OF COFFEE BEANS

Dr W. S. MAUGHAN

Gunson's Sortex Ltd

London

Prof. Dr Ing. S. MILO

University of Trieste

Dept of Electronic Engineering

Dr Ing. L. ROARZI

Illycaffè S.p.A.

Via Flavia, 110, I-34147 Trieste

INTRODUCTION

The purpose of this study is to illustrate the computerized system currently in use at Illycaffè S.p.A. of Trieste for measuring the colorimetric characteristics of different lots of green coffee.

The system basically consists of an HP 1000 Computer System and a 425 C Sorting Machine from Gunson's Sortex Ltd., appropriately adjusted for our project.

In order to fully evaluate the effectiveness of various methods of data transformation, it is obviously necessary to obtain the required measurements on a statistically large number of coffee beans and to be able to separate a coffee bean lot into sub-lots of defined characteristics for subsequent analysis. The amount of work involved would be too great to undertake by purely manual methods and it was necessary to have available a suitable high-speed automatic sorting machine.

For this purpose, a Gunson's Sortex Type 425C Machine was selected as being the industry standard at that time for the sorting of Arabica Coffee. This machine was suitably modified by the Manufacturers to provide the necessary data and control outputs for coupling to the Data Acquisition System and for accepting and acting on instructions from the Computer.

In the following section, the standard 425C Machine and the special modifications necessary for this project are described.

The 425C Sorting Machine

The Sortex 425C is a twin channel, chute feed, bichromatic sorting machine. Each channel consists of a feeding, inspection and separation system and each of these will be described in turn.

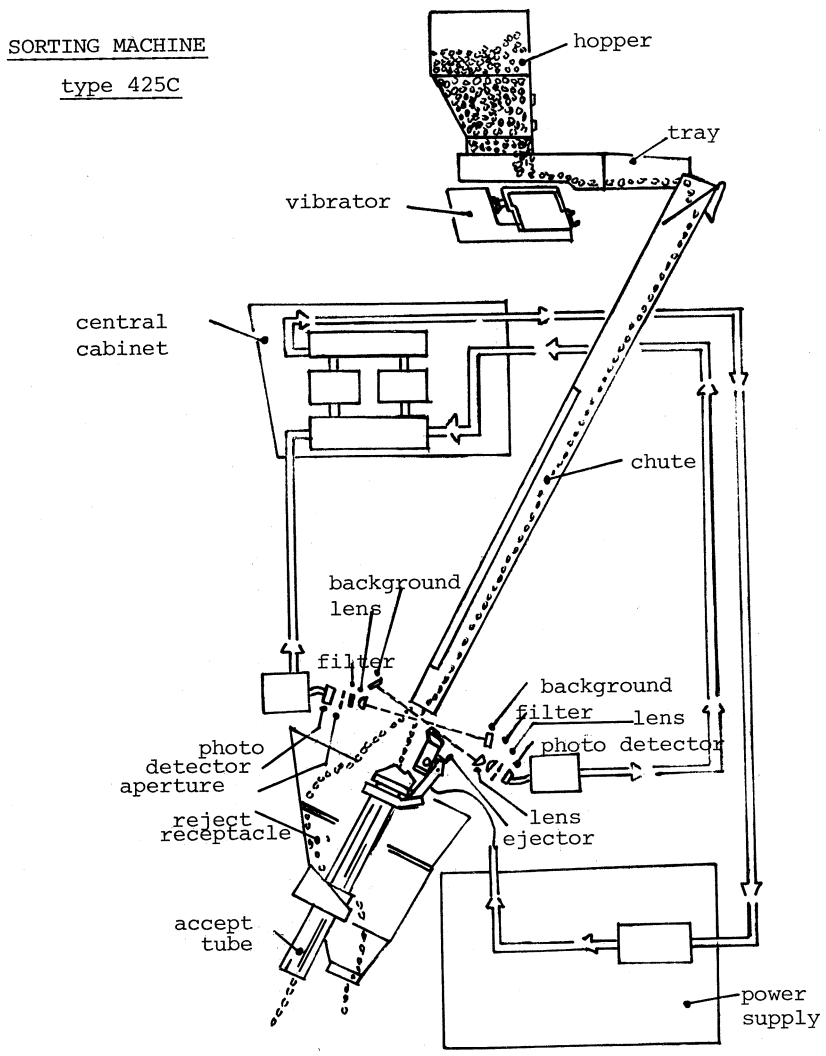

Fig. 1

The feeding system (Fig. 1) is designed to transport the beans from a hopper in a defined trajectory through the inspection and separation systems. The throughput of the channel is determined by means of an electro-magnetic vibrator, which feeds beans from the holding hopper onto an inclined chute. The beans are then accelerated and aligned by the U-shaped chute, so that they fall in single file through the exact centre of the viewing chamber. As each coffee bean falls through the viewing chamber, it is illuminated from all directions by means of incandescent lamps and the diffuse reflectivity of the bean's surface is measured simultaneously from a number of directions.

The field of view of each measuring direction is in the form of a thin horizontal slit approximately 15 x 1,5 mm, and this results in a signal pulse being developed in one or more of the photo-electric detectors as the bean passes through the viewing area (Fig. 2)

The simplest type of sorting machines make measurements in a single wave length or colour band and are known as Monochromatic Sorters. Such a machine is illustrated diagrammatically in Fig. 1 and shows two directions of viewing. However, where more subtle colour sorting is required, involving the ratio of reflectivity measured in two separate wavelength bands, such as in the case when sorting green Arabica Coffee, a bichromatic machine is needed.

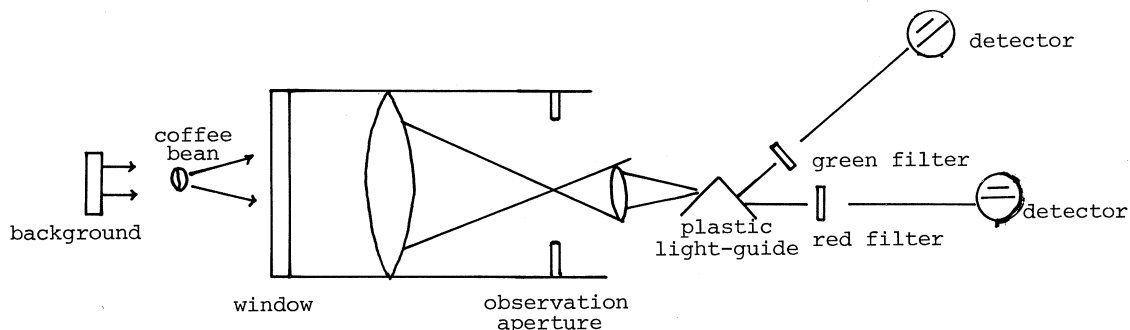

Fig. 2

The 425C measures the reflectivity in three different directions. Two of these directions have true bichromatic capability employing a plastic light-guide to split the reflected light into two separate paths which can then be passed through suitable optical filters to define two separate wavelength bands. The two bands, say green and red, can then be converted in two photo-detectors to two electronic signals ready for evaluation or processing. The third direction is also split into two paths, one of which is used for a single monochromatic measurement (usually green) and the other is used to provide an optical clamp signal. This is essentially a presence signal, operating in the near infra-red and is used in the electronic processing for the D.C. restoration of A.C. coupled

signal paths.

As the beans fall through the viewing chamber, they are inspected against a carefully selected colour background which is usually chosen to match the average colour of the beans being sorted. As this background gives a steady light signal in the intervals between beans, advantage is taken of this to provide a system of Automatic Gain Control (A.G.C.) which adjusts the gains of the photo-detectors so as to compensate for any ageing of components or build-up of dirt in the viewing chamber.

The 425C is a very versatile machine in that it can be set to reject a coffee bean which exceeds a pre-set threshold on any one or more of the following measurements:

Monochromatic - Red : Too dark from one or two directions
" - Red : Too light " " " " "
" -Green: Too dark " " " " or three directions
" -Green: Too light " " " " " " "
Bichromatic - Red/Green Ratio: Too red from one or two directions
" - Red/Green Ratio: Too green " " " " "

When a bean is classified by the inspection system as being a 'reject' a signal is passed to a high speed solenoid valve which causes it to release a short blast of compressed air through a nozzle at the instant that the 'reject' bean is passing in front of the nozzle. This causes the 'reject' bean to be deflected out of the main stream of beans and to be collected in a separate receptacle from the 'accept' beans. Normally, the distance from the point of inspection to the nozzle will be approximately 4 mm which ensures that the nozzle does not interfere with the optical measurement and allows time for the solenoid valve to open, however, this can be increased to come 50 mm by electronically delaying the pulse to the solenoid valve and, in this way, the inspection chamber can be kept clean when sorting dirty products.

Special Modifications

The standard 425C makes its decision on each bean according to whether or not the signal or signal ratios for this bean exceed pre-set thresholds. Therefore, the most important parameter of each signal is the peak height which generally occurs as the coffee bean is positioned so as to occupy the maximum part of the viewed area. It was thus decided that initially, the machine should be modified so that analogue voltages equal to the pulse heights, would be available for connection to the Data Acquisition System. If, subsequently, it proves necessary to obtain further information about each pulse then a high speed scanning system could be incorporated to give a series of readings corresponding to each pulse. Only one channel of special electronics was provided with the sorting machine

but this could be simply switched to acquire data from either of the two sorting channels.

Peak Height Detectors (P.H.D.) were provided for each of the five measurements (2 red and 3 green) mentioned above. Because the signal from a coffee bean could be positive or negative or both, depending on its' colour(s) relative to the colour background, the P.H.D.'s had to be capable of recording the maximum signal irrespective of polarity. The clamp or presence was utilized to provide a 'data ready' signal to the Data Acquisition System as soon as the measurement was complete (i.e. as the bean left the viewing area) and the Data Acquisition System transmitted a 'data accepted' signal back to the 425C which was used to reset the P.H.D. ready for the next bean.

It will be apparent from the foregoing, that should a second bean arrive in the viewing zone before the data on the previous beans has been acquired by the Data Acquisition System, then part of the signal from the second bean will be missed and incorrect data may result. Circuitry was, therefore, arranged so that data from any bean entering the viewing zone before receipt of the 'data accepted' signal was ignored. This configuration was acceptable for experiments involving data acquisition only, but, of course, for sorting experiments, all beans must be assessed and, therefore, it was necessary to be able to slow down the throughput of beans through the inspection system so as to provide adequate clearance between beans. This was achieved by the provision of a special dual vibrator system between the hopper and the feed chute.

Circuitry was also provided to accept reject instructions from the Computer and to interface them correctly with the solenoid valve so that the correct 'reject' beans were separated out.

Thus the modified machine is capable of carrying out sorts in accordance with decisions arrived at by mathematical manipulation of the five bits of data provided by the machine to the Computer.

The Computer System

Therefore five analogue signals are sent from the sorting machine to the Computer. Initially these data were collected by a data acquisition subsystem consisting of a scanning unit and a digital voltmeter which digitise and measured the signal which they received. Later, however, we improved this acquisition unit by using a HP2240A Measurement and Control Processor which acts as an intelligent interface between the computer and the Sortex Machine. This device may be microprogrammed, i.e. may receive from the computer a whole series of commands which are stored in an appropriate task buffer of the HP 2240A and which are carried out one by one.

The data which are obtained are recollected in the task buffer where, at the end of the whole series of commands, the computer will read them.

In Fig. 3 the operation of the HP2240A may be seen in diagram form.

Note the three function cards which interface the outside world (Sortex Machine) with the task processor which, by elaborating the information provided by the cards, prepares the data to be sent to the central processing unit of the computer according to the instructions contained in the task buffer.

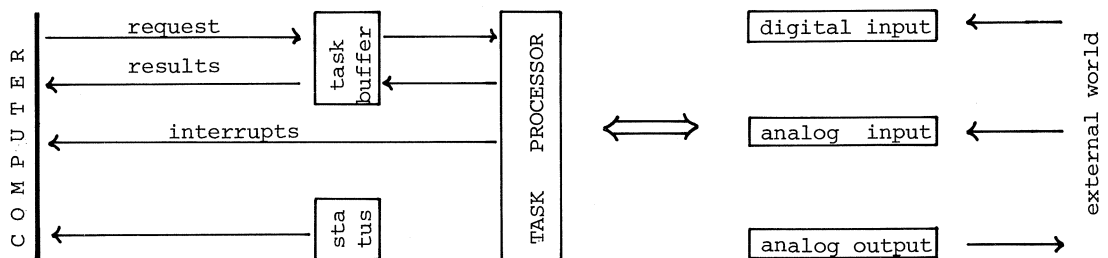

Fig. 3

The six signals from the sorting machine are distributed in the following way:

- the data ready is processed by the DIGITAL INPUT CARD;
- the five signals carrying the information in the two colour bands, green and red, of the bean are processed by the ANALOG INPUT CARD;
- the ANALOG OUTPUT CARD provides the two signals, one to reject the bean and the other to reset the electronic circuits for the reading of the next bean.

Finally we come to the brain of the entire system, the Central Processing Unit.

This is a 21MX E-Series Computer. It is this which, once it has received the

Fig. 4

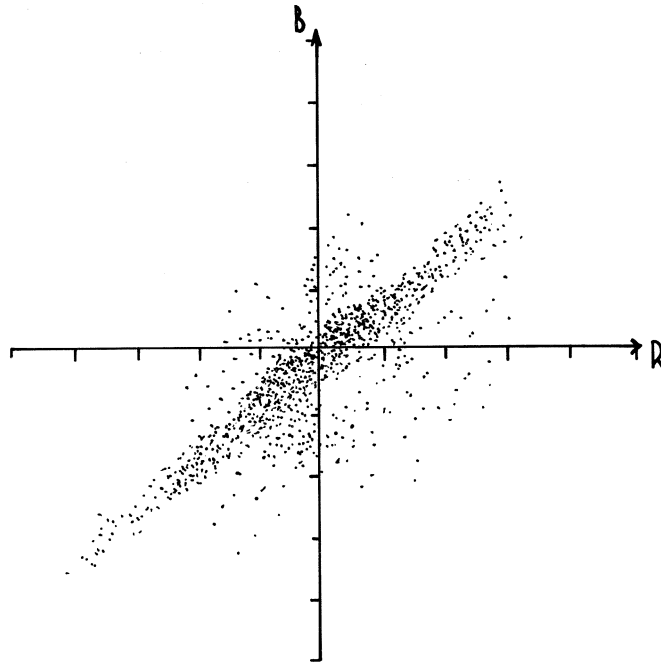

information on the colour of the bean, initiates a whole series of operations to decide whether to accept it or not. Broadly speaking, the operations are the following:

After providing indications on the background which most closely meets the average colour of the lot of beans to be sorted, the computer memorizes on disc the data relative to 2000 beans which the sorting machine provides. These 2000 beans are taken as a sample of the lot to be sorted.

The sorting machine stops and the computer initiates a whole series of mathematical operations to calculate the statistical parameters of those 2000 beans and in particular constructs the covariance matrix of the sample.

At this point, on the basis of the analysis of this matrix, the computer determines whether or not it is necessary to carry out a vectorial transformation of the 5-dimensional space to arrive at a new 5-dimensional mathematical space, where the information content of the 5 signals is concentrated into only two parameters which we have called A and B and which characterize , with their values, the coffee bean read.

At this stage the decision on the quality of the bean depends on the value of only two parameters and not five as in the original space of measurement. It is obviously why it is now much more simple to decide on the quality of the bean.

We add that the vectorial transformation of the space of measurement is obtained by the matrix of the eigenvectors obtained from the covariance matrix of the sample of the previous 2000 beans.

See in Fig. 6 an example of this matrix.

Once the stage of determining the statistical parameters has been completed, the sorting machine starts again, carrying out the sorting process, on the basis of the statistical parameters which it now knows.

A visual aid to the mathematics is provided by the DIGITAL PLOTTER which plots on a two-dimensional plane the distribution of the original 5-dimensional space, where the readings made by the sorting machine are averaged into one single value for the green and one single value for the red.

Fig. 4. shows a typical distribution.

This is the covariance matrix

1,75177	1,62286	,84618	,87628	,17699
1,62286	1,93948	,91027	,84440	,23819
,84618	,91027	2,11682	1,80691	,42253
,87628	,84440	1,80691	1,98526	,37783
,17699	,23819	,42253	,37783	,79919

This is the normalized matrix

1,00000	,88044	,43942	,46989	,14959
,88044	1,00000	,44925	,43032	,19132
,43942	,44925	1,00000	,88143	,32486
,46989	,43032	,88143	1,00000	,29996
,14959	,19132	,32486	,29996	1,00000

This is the eigenvectors matrix

,47579	-,49700	,15067	,49649	,50340
,47423	-,48331	,21887	-,49551	-,49409
,49377	,34581	-,36416	-,51577	,49221
,49353	,32553	-,39339	,48953	-,50991
,24770	,54208	,80126	,04805	,01356

Fig. 6

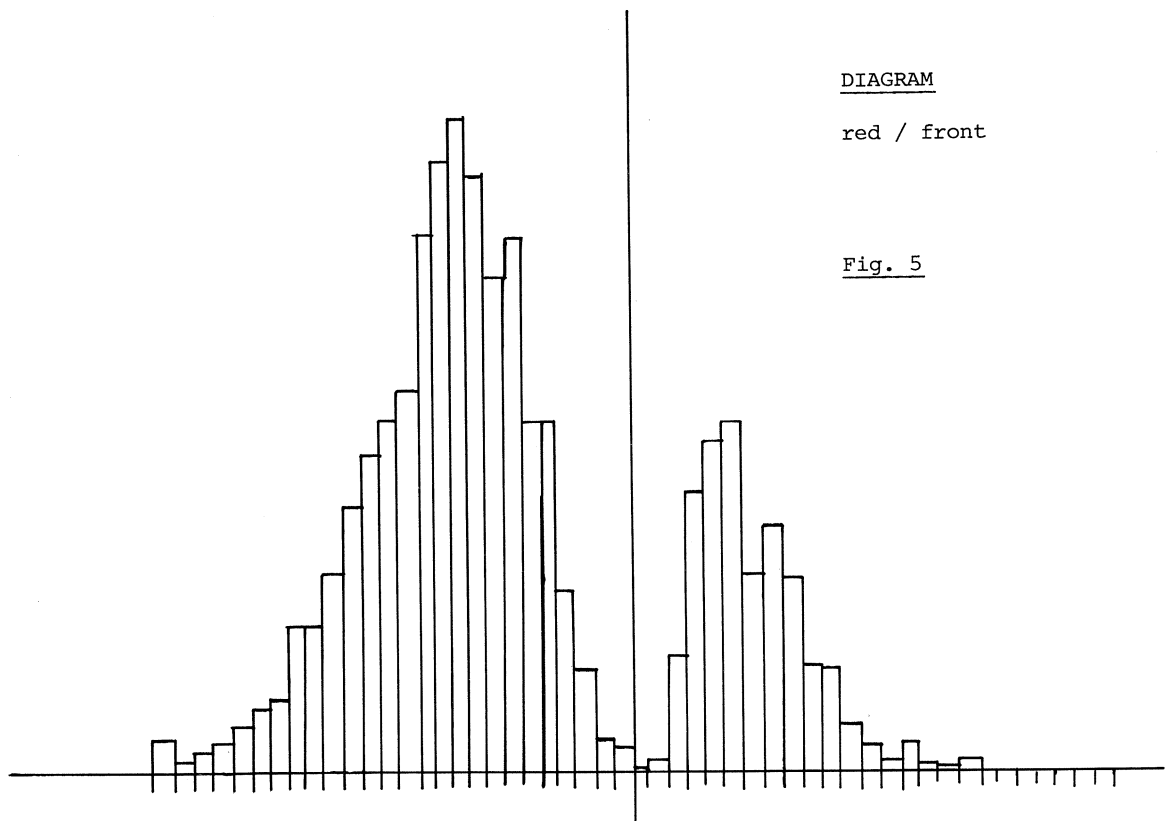

DIAGRAM

red / front

Fig. 5

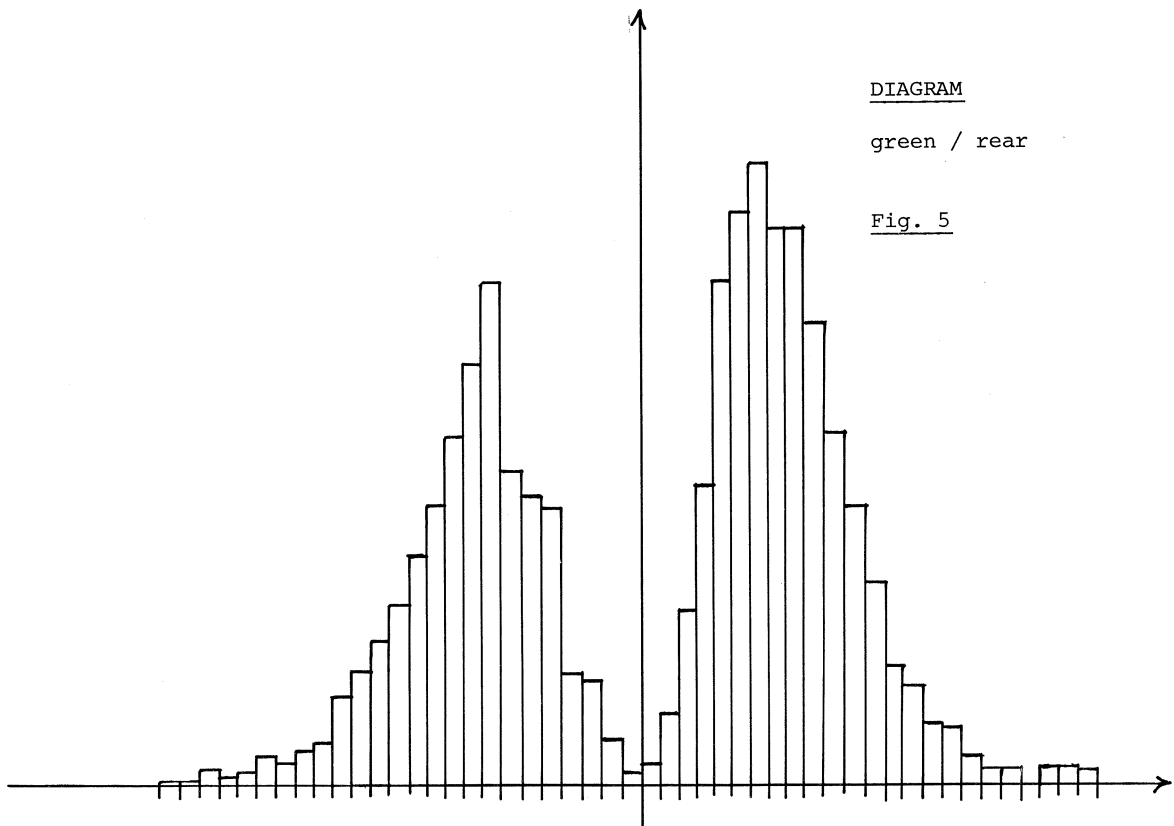

DIAGRAM

green / rear

Fig. 5

When the distribution of the original average red and average green readings is compared with the distribution of the new "A" and "B" parameters, it is noticed that the later distribution is expanded and will, therefore, be easier to divide into sub-distributions of given spectral characteristics.

Another useful visual is provided by tracing histograms of the sample of 2000 beans.

There are five histograms, one for each channel of information which comes from the sorting machine. These provide information not only on the efficacy, but also on the industrial profitability of sorting the particular lot of coffee. Each histogram shows in fact the relative frequency (i.e. the percentage of beans) which the photomultiplier in question detected as having a given reflectivity relative to the background. Therefore, on the basis of the height of the histogram at various points in its range, it is easy to distinguish the quantities of coffee with different characteristics that are present in the sample examined.

In Fig. 5 we illustrate as an example the histogram of the beans seen by one of the photomultipliers in the red band and one in the green band.

For example, the shaded areas may correspond to beans having green reflectivity which is a certain amount darker or lighter the background, which classifies them as reject. The shaded area therefore represents the proportion of the lot to be rejected.

PATTERN RECOGNITION IN SORTING GREEN COFFEE BEANS

Prof. Dr Ing. S. MILO

University of Trieste

Dept of Electronic Engineering

1. Defining the Problem

Due to the difficulty coffee roasters are faced with in obtaining green coffee of constant quality, it is becoming increasingly necessary to be able to sort out the coffee bean by bean before roasting.

For some time now machines have been used for this purpose, machines which sort the beans on the basis of their colour, or rather on the basis of the reflectance of the individual bean. These machines are considerably sophisticated in the feeding of the beans and in carrying out the measurements, but as the decisions made by the machine are fairly elementary, the maximum potential of the method is not being realized at present.

The problem nowadays is therefore that of finding more valid criteria which are more elaborated from conceptual point of view, without introducing operational complications.

The use of microprocessor in this field of technology can provide beneficial results, provided that the problem of determining the sorting criteria is solved beforehand.

This report suggests one approach to solving this problem, an approach which consists essentially of an availability of automatic techniques for choosing from a lot of green coffee those beans which will produce an end product of

acceptable quality.

Expressed in this way, the problem to be solved is a problem of "classification", i.e. we wish to individuate all those beans which belong to the class "beans which, processed perfectly, can produce a good coffee cup". Obviously while the definition of class by the properties of the elements of which it is composed, is evident; given a bean, it is impossible to decide immediately if the bean belong to the class. As the knowledge on this topic stands, there are no tests that one may carry out in order to take this decision, even if the experience of the users in this sector has enabled them to derive valid empirical rules which can provide criteria for choosing good beans and other non-valid ones, when sorting the beans by hand.

The complexity of hand-sorting and the difficulty in applying all the rules advise the maximum use possible in the final stages and a very limited use in the preliminary stage of study and research.

The empirical rules are based on the colorimetric properties of the bean; it is however known that there is a considerable correlation between the colorimetric characteristics of green coffee and the quality of the end product.

The present approach suggested is based on this assertion, which is justified both by experience and by numerous organical chemical tests.

Since the colour of green coffee depends on the chemical reactions which have taken place or are underway on its surface, it is evident that more than the colour as it appears at our eyes, that which interests us is the response spectrum of the bean itself, i.e. the reflectance of its surface in function of the different wavelengths of the incident light.

We may claim that there is a difference between the spectra of reflectance of beans which will produce good coffee and those which will not.

In this case it may be stated that the problem which was initially one of "classification" becomes one of "pattern recognition", i.e. it is a question of distinguishing between spectra of valid beans and spectra of nonvalid beans.

It appears evident that it is not possible to measure the reflection factors for every wavelength of the spectrum visible for each coffee bean to be used. It is therefore necessary to limit ones measurements to a few data (e.g. 4) relative to the coefficient of reflection on four particular bands of wavelength.

With these data it is necessary to determine the sorting criteria and to

actually sort the beans concerned.

To solve this problem we used a process which may be considered in three phases.

In the first phase the colorimetric characteristics of a representative number of beans from a lot of coffee are measured.

In the second phase, on the basis of the data measured, the parameters which characterize the sorting criteria are derived.

In the third phase the actual sorting of the entire lot of green coffee is carried out on the basis of the parameters calculated in the second phase.

2. Attributes Measured

As we have seen, there is only a limited number of data for each pattern to be classified.

Therefore it is initially a question of

- a) individuating the characteristics of the families of spectra of valid beans and families of spectra of non-valid beans;
- b) reducing the effects of the dispersion of the spectra of the same bean in function of the surface analysed.

For the coupling of the sorting machine to the computer which acquires the data from the representative beans and which subsequently calculates the sorting criteria and for the technique of measurement of the data concerning the reflectance of the bean in 4-6 bands of wavelength, see (Maughan-Milo-Roarzi) "Instrumentation System For the Analysis of Coffee Beans" (ASIC-IX Colloquium).

The choice of these bands must take into consideration points (a) and (b) quoted above, i.e. one must take measurements which corresponds to the wavelength, with the result that the spectra of the beans likely to produce a good end product are far from the spectra of the unsuitable beans. Simultaneously one must contrive to reduce the dispersion of the measurements on the same bean, due to many causes, among which the most important seem to be the intrinsic dissymmetry of the bean, the difference in colour of its surface, the different position of each bean with respect to the sensors.

3. Pre-Processing of the Data Measured

The pre-processing of the data has several purposes, among which we recall:

- a) elimination of the systematic errors in measurement
- b) elimination of the influence on the measuring of parameters which are of no interest to the work of classification
- c) simplification of finding the sorting criteria.

Pre-processing may be interpreted as a transformation which enables us to pass from the space of the primary attributes, i.e. those actually measured, to that of the "secondary attributes", i.e. those calculated on the basis of the primary.

The dimensions of the two spaces are usually different. If x_i are the M attributes measured on a bean, the law of transformation will be expressed by:

$$y_j = f_j (x_1, x_2, \dots, x_i, \dots, x_M) \quad j = 1, N$$

where y_j is the value of one of the attributes of the new space.

The functions f_j are chosen by the researcher - there is no general criteria for choosing the functions themselves, but a criterion for verifying the validity of the choice made.

A simple test which will indicate whether points (a) and (b) mentioned above are fulfilled consists in taking a repeated measurement of the same bean and checking that the dispersion of the points in the space Y is minimum.

With respect solely to the pre-processing of readings taken which can reduce the effect of parameters which are not considered of interest to the problem of classification, the so-called "principal factorization" was noticed to be true.

This factorization would seem the most appropriate operation to carry out on the data especially if we take into consideration that the sensors are usually installed in the measuring instrument symmetrically and placed on the same diameter. In this way it is possible to "mediate" the data to the maximum, reducing the effects of the intrinsic dissymmetry of the bean, automatically taking into consideration eventual different gains of the measuring instrument or of privileged positioning of the beans with respect to those instruments.

Un the case of (a), the bans of measurement are individuated by systematically using a reflectance spectrophotometer.

With this device, after having taken considerable measurements both of valid and non-valid beans, it is possible to individuate the best setting and band width for each type of coffee.

One should bear in mind that it is always best to choose bands around the red and around the green/blue.

In the case of (b) it seems better to choose not 4-6 bands, but only 2-3, i.e. different filters are produced on sensors arranged symmetrically with respect to the bean.

As a result of these findings and the pre-processing methods which will be illustrated in the next paragraph, it is possible to reduce the number of data on each bean without wasting too much information useful for classification and the dispersion of the data relative to measurements taken of the same bean is considerably reduced.

4. Principal Component Transformation

In this paragraph we shall describe a data processing technique which makes it possible to reduce both the number of parameters to be considered in the actual classifying and the effects of measurement errors.

We must first of all bear in mind that the significance of a parameter may be evaluated according to the dispersion around the average value, i.e. according to variance, while the increase in information by simultaneously taking into consideration another parameter may be evaluated from the covariance.

Variance and covariance however depend on the measurement errors, as a result of which a very diffused parameter may be very meaningful and/or may have been measured with many errors.

We remind you that the measurement error is a value in addition to the "true" one, in no way related to this or any other useful data obtained from the bean, nor is it even related to the measurement errors in the other parameter of interest to the bean.

We therefore find ourselves comforted with the following contradictory situation:

- a) it is useful to measure non-correlated parameters, as each new measurement adds more information to that already available;
- b) it's worthwhile using closely related parameters, as in this way the effects of the measurement errors may be reduced.

Accepting a compromising situation, there is still the problem of "cleaning" the data, i.e. individuating that group of unrelated secondary parameters with high variance and where the measurement errors only slightly affect the variance.

This task may be carried out using the transformation according to the main factors.

The vector in which M elements are the values of the parameters read from a single bean let us call \bar{x} the matrix whose lines are the vectors of \bar{x} for K beans X .

The value of the covariance matrix is therefore:

$$V = \frac{1}{K} X^T X$$

If we call a matrix $M \times M$ T , we can say

$$\bar{y}^T = M \bar{x}^T T$$

The secondary parameters, elements of the vector y , are still M , but by correctly choosing the transformation matrix T it is possible that the covariance matrix of the secondary parameters will be diagonal, i.e. that all the parameters will be unrelated to each other.

It will therefore suffice to take into consideration those with the greatest variation to have the dimensions of the space of the parameters and simultaneously the effects of the measurement errors reduced.

As we have seen, the matrix T which enables us to do this transformation is the matrix obtained from the autovectors of the matrix V .

5. Conclusions

After having completed the above-mentioned transformation we may proceed to the individuation of the cluster in the space of the secondary parameter, which may be smaller than that of the primary parameter.

For the classification we have thus chosen the path of spontaneous aggregation of elements in the space of the parameters, in that we are sure of a cluster-class interrelation, thanks to the preliminary analysis carried out with the spectrophotometer. Nevertheless, the final stages must be terminated by experiment.

With the instruments illustrated in the cited work it is therefore possible to proceed to the selection of each cluster found and, by experiment, determine whether it belongs to the class in question.

The method suggested for improving the quality of roasted coffee may perhaps seem complex, but we would remind you that it only seems so, as it is possible to carry out all the operations completely automatically and inexpensively with apparatus composed of microprocessors.

E. ILLY

The two previous lectures with their highly specialized mathematical content may seem unusual with the aim of our association.

I want to add a few words explaining the use of the described process.

We hope to be able to find a correlation between the colour of a coffee bean, its chemical composition and its organoleptic characters.

First we will select from a lot the characteristic healthy and defective beans and we will determine their remittance spectra.

With the data so obtained we will use a bichromatic Sortex machine controlled by a computer for the selection of uniform group of beans.

The uniform groups will be further analyzed:

- for the chlorogenic acid content in the laboratory of Surrey University by prof. Mike Clifford;
- for the oligo elements content and pyrolytic and mass-spectrometry by dr. Marco Quijano Rico in the laboratory of the Federation National de Cafeteros de Colombia;
- for the sterols content by dr. George Kulaba of Kenya Industrial Research and Development Institute of Nairobi;
- for the organoleptic characters of the roasted samples and
- for the headspace gaschromatographic analysis of the samples in our laboratory in Trieste.

We hope that the result of this combined effort of some friends interested in deeper knowledge of what we understand as "coffee quality" will be successful, and we invite any other laboratory interested in the remaining areas that are not covered by research like lipids, sugar, waxes, etc. to join our effort.

Interested people are kindly asked to contact me.

COFFEE SORTING WITH UV EXCITATION



H. J. CARTER

R & D Project Manager

Icore Division, Acurex Corp. California

Introduction

A few years ago certain coffee producers were introduced to the concept of ultraviolet-stimulated fluorescent sorting of green coffee beans. The idea was that particular defective beans would fluoresce that otherwise could not be distinguished from good beans. Therefore, a fluorescence sorter should improve the quality of the coffee.

Today this idea is still being used to help sell these UV sorters, but there are relatively few UV sorters in use compared to the visible light reflectance sorters. Most of the usage appears to be in East Africa where the idea of UV sorting seems to have taken hold. There does not appear to be much interest in UV sorting elsewhere.

After receiving various comments gathered from knowledgeable coffee production personnel, we at Icore decided to run some experiments with fluorescence sorting to find out if there is a correlation between fluorescence and taste. Icore is presently seeking new applications of its recently introduced UV sorter which has been used successfully in sorting almonds and other tree nuts. It is obvious that the successful application of this machine to coffee sorting depends on finding such a correlation.

We have sorted many coffees with this machine and then cupped them, with, I regret to say, negative results as far as taste is concerned. Before I proceed to describe these tests and the specific conclusions we have reached, let me briefly review the art of coffee color sorting.

Educated at the University of Chicago and the State University at Long Beach, California (B.A. Physics), Mr. Carter has over 20 years experience designing electronic and optical instrumentation.

Color Sorting

The sorting of green coffee beans is accomplished with the conventional color sorter by illuminating each bean in turn with visible light. The light reflected from the bean is measured at various wavelengths using suitable filters and photodetectors. However, our fluorescence sorter illuminates the beans with longwave ultraviolet (LWUV) light and measures the emitted fluorescent light, excluding any reflected light.

In either case a comparator then evaluates the detected light energy. A reject command may then be generated to cause separation of "good" or "bad" beans.

The class of bad beans includes obvious visible defects such as black or very dark brown beans, and also nearly white beans. Another group of beans which could be bad, depending on the coffee type and origin, has a range of greenish-bluish-yellowish-tan colors, often mottled, with varying degrees of overall lightness. Also, the colors may be obscured by the onionskin, unless the beans have been polished. We will show later that most good beans are fluorescent. Also, there are a few high quality arabicas which have good, non-fluorescent beans.

There is another, somewhat elusive defect, called "stinker" which is defined in many ways. Often, a coffee expert who picks out a bean he thinks may be a stinker, is unsure of the classification, so he makes a destructive test to confirm his suspicion; i.e., he bites the bean. We have observed that the bean fragments confirmed as stinkers by this method are not any more likely to be fluorescent than are the normal good beans.

Let's look now at a fluorescence sorter and its working parts.

Here is a view of the new machine, in this case a four lane version fed from a common hopper.

Next, we see a close up of the control panel. You will notice the monitor jack in the top right side of the panel. A unit we call a reject monitor may be plugged into this jack to enable numerical information on the reject rate to be recorded by an operator.

Here is a view of the reject monitor with its digital readout.

Next, look at the block diagram (Figure 1) showing the principal operating parts of a color sorter. Any color sorter will include the basic subsystems which we refer to as the Singulator, the Classifier, and the Rejector.

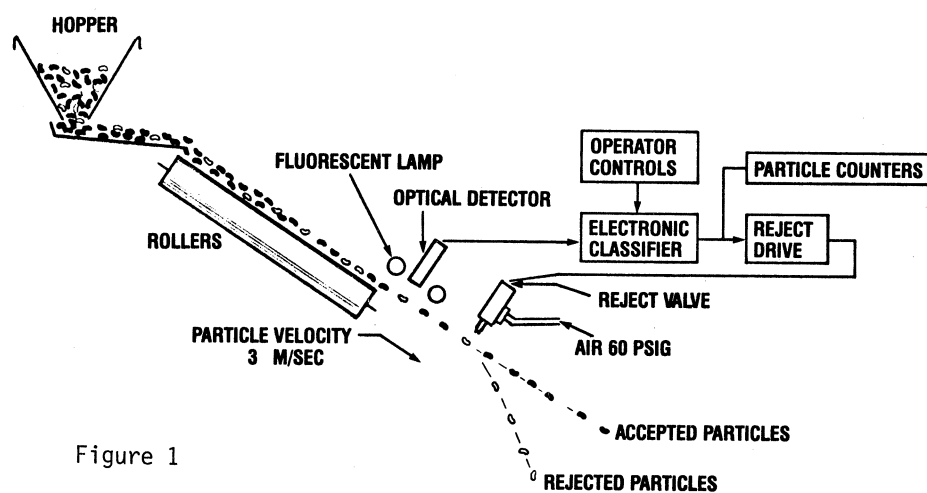

Figure 1

BINARY FLUORESCENCE SORTER BLOCK DIAGRAM

The purpose of the Singulator is to permit each individual particle to be inspected. The Icore machine singulates the product by allowing it to accelerate on contra-rotating rollers to achieve particle speeds of about 3 meters/sec.

The particles then pass through an inspection station or scanner where they are self-scanned by stationary optics and detectors which generate signals suitable for classifying the particles. Using threshold conditions pre-set by the operator the classifier will accept or reject each individual particle. At a suitable later time after classification a current pulse is sent to actuate the air valve to deliver a brief air blast directed at the particle to be rejected. This, together with a diverting chute, constitutes the Rejector subsystem.

A binary sorter (either conventional or fluorescent) makes two kinds of errors, so two numbers are required to specify the machine efficiency. They are called sort efficiency (E_s) and reject efficiency (E_r) and are calculated from the quality ratios of accept (Q_a) and reject (Q_r) outputs, and of incoming material (Q_i). The following equations are used to calculate the efficiencies. Figure 2 is a graphic representation of the variables.

SORTER EFFICIENCY CALCULATIONS

Input Quality: $Q_i = \frac{A_g + R_g}{A_g + R_g + A_b + R_b}$

Accept Quality: $Q_a = \frac{A_g}{A_g + A_b}$

Reject Quality: $Q_r = \frac{R_b}{R_b + R_g}$

Sort Efficiency: $E_s = \frac{Q_a - Q_i}{1 - Q_i} (100) \%$

Reject Efficiency: $E_r = \frac{Q_r - Q_i}{1 - Q_i} (100) \%$

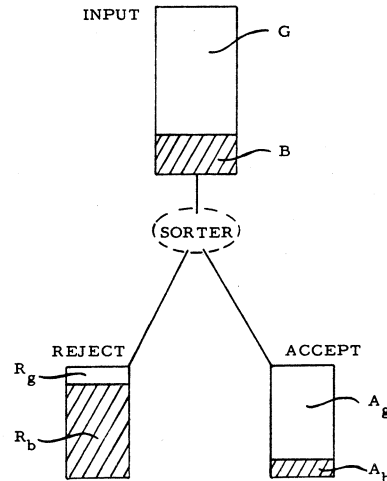

Figure 2

Machine efficiency refers to the effectiveness of the sorting process as related to the quality of the input material, and cannot be estimated from the output quality ratios alone.

What the operator sees when he scoops up a handful of beans from the Accept or Reject outputs is a mix of both good and bad beans. The ratio of good beans to the total in the sample, or the ratio of bad beans to the total is a measure of the output quality of the Accept and Reject outputs, respectively.

Considerable care is required to accurately measure machine efficiencies, and sample sizes have to be equal. Manual sorting of the samples must be done to verify the machine classification of each particle. It should also be remembered that the machine efficiencies are reduced as throughput increases. They are always less than 1 because the perfect sorter does not exist.

In the case of a fluorescent sorter we set up the classifier to cause rejection of particles which are either non-fluorescent, or emit more fluorescent light than a preset, adjustable threshold value which was determined after several trials by computer simulation of the classifier operation.

The accepted and rejected output particles from the machine can be easily inspected with a viewing box fitted with an ultraviolet source similar to the one used in the scanning head. Using this inspection box we handpicked the machine outputs of our samples in order to eliminate machine errors in the determination of the correlation between fluorescent beans and perceived taste.

Coffee Bean Fluorescence

Let us turn now to a consideration of the fluorescent light emitted by coffee beans under longwave UV excitation. To do this we use a computer controlled scanning spectroradiometer, as shown here, to measure the fluorescent irradiance. It uses a Hewlett Packard 9825S calculator to control the monochromator and light source, and processes the radiometric data after calibrating itself against a known standard source of illumination.

Fluorescence measurements of typical coffee samples are shown in the next slide (Figure 3) which shows plots of the fluorescent irradiance as a function of wavelength. The most interesting feature we found in this data is that the emission spectra of all the green coffee samples tested had a common peak emission. This peak lies in the blue region of the spectrum.

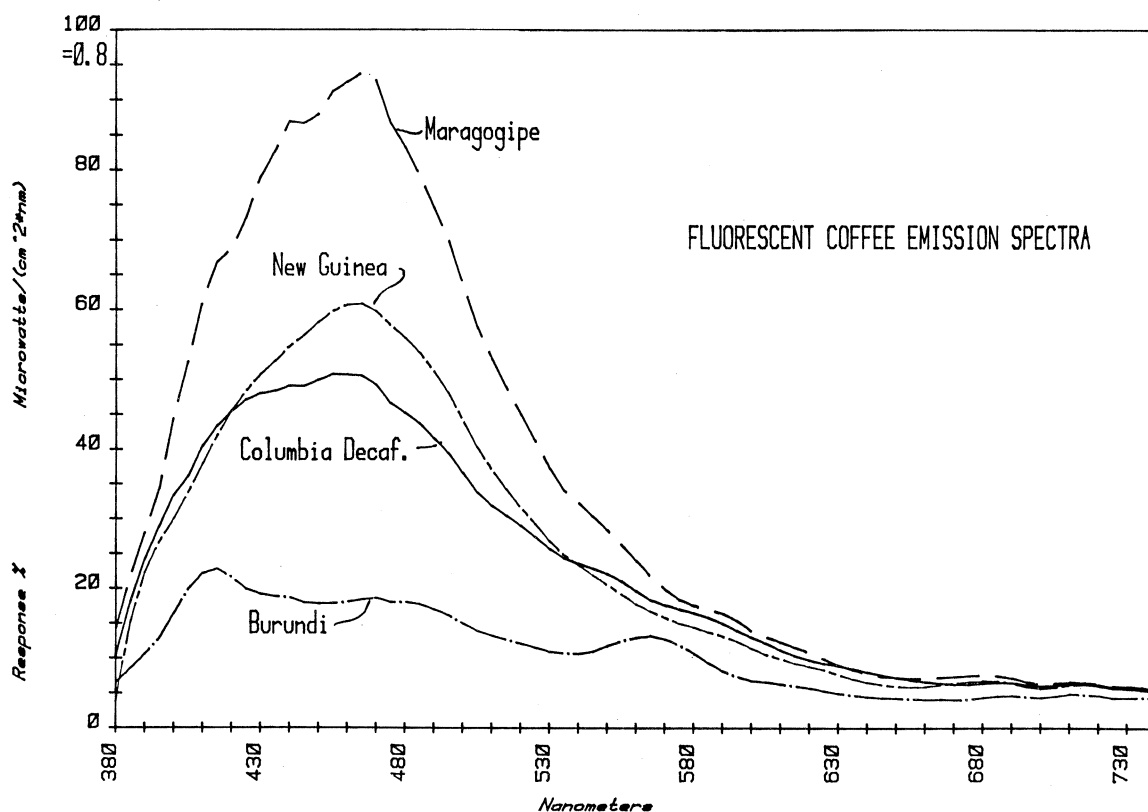

Figure 3

The next slide shows the gamut of colors corresponding to the CIE diagram.

When these spectral distributions are analysed colorimetrically and plotted on the 1931 CIE chromaticity diagram (Figure 4) we see that the points all lie nearly on a line of constant chromaticity. The principal wavelength is 470 nanometers, with only a variation of saturation distinguishing each sample. This is of course, consistent with the variation of relative peak intensity of the spectral distributions shown on the previous slide. We will show later that this variation bears no relation to the perceived color of the beans when viewed under a standard illuminant (D65).

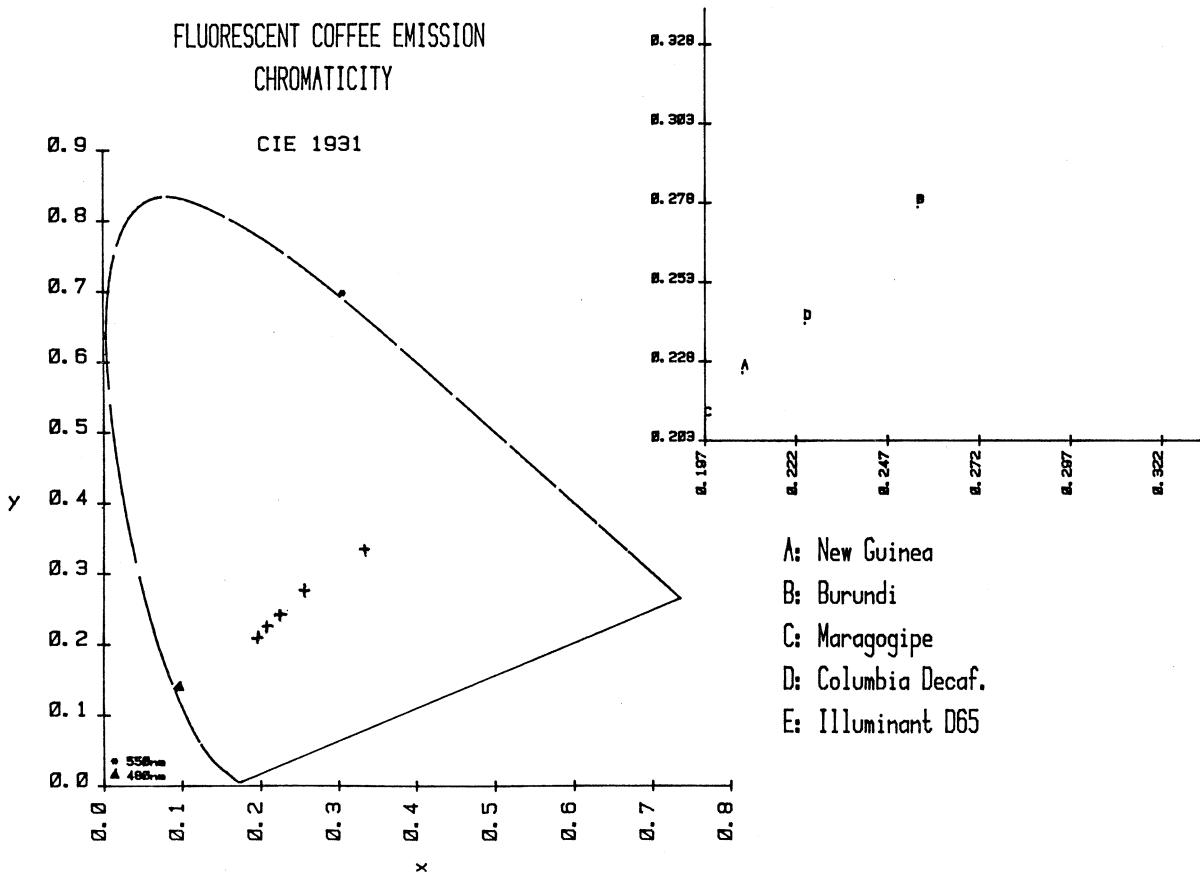

Figure 4

Our spectroradiometer system also calculates the numerical chromaticity data and gives the integrated flux value. The data for a New Guinea sample is shown. (Figure 5)

-Data analysis-

Device:
na c fl

Irradiance:
7.026E 01
microwatts
/cm²

Photon
irradiance:
1.753E 14
photons
/(sec*cm²)

Tristimulus
values:
X = 1.581E-01
Y = 1.711E-01
Z = 4.333E-01

Chromaticity
coordinates
(CIE & UCS-76):
x = 2.073E-01
y = 2.244E-01
u' = 1.571E-01
v' = 3.826E-01

Figure 5

Next, let us look briefly at the beans which gave these spectral results when excited by LWUV. The photographic process distorts the apparent color but you can see that there is a pronounced blue fluorescence. The same beans, viewed in light approximating daylight, are seen in the next slide. From left to right, the beans are from Burundi, Columbia Decaf, New Guinea, and Guatemala.

Our researches into fluorescent coffee sorting led us to measure the emission under LWUV for a number of other coffees. Although we have not exhausted the list, we believe that the variations in emission we have found will be similar for all arabica coffees, washed or naturals.

Examples of fluorescent emission under LWUV for some of the other coffee samples are shown in the next slide. Notice the great-variation in emission for (say) the Mexican plumas and the Burundi arabicas. When these coffees were informally cupped we found no correlation of taste with the presence or absence of fluorescence. Incidentally, a blend of green beans might be detected or separated by fluorescence sorting. It is doubtful that there would be any economic justification for routinely separating blended green beans.

Cupping Experiments

Next, the same coffees are shown under incandescent light. We decided to make several specific cuppings of some coffees which could be easily sorted into fluorescent and non-fluorescent categories. We used an arabica from Burundi, a maragogipe from Guatemala and a Mexican pluma for these tests. All tasting was done in the blind by tasters with many years of experience.

The test protocol for the Burundi sample is shown in the next slide (Figure 6).

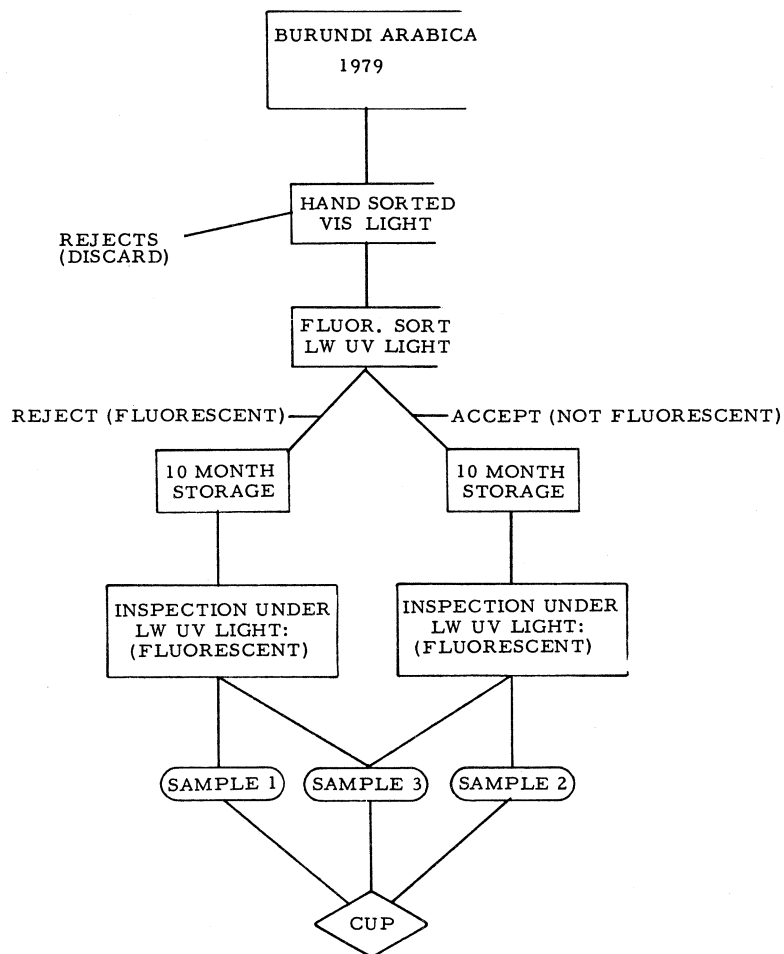

Figure 6

The Burundi coffee was sorted a year ago into fluorescent and non-fluorescent categories after first sorting out the usual visual defects, including beans which were not polished. The samples were then stored at room temperature, and approximately a year later were reexamined under UV light. At that time both samples were found to be equally fluorescent. Both samples were cupped, together with a 50-50 mixed sample of each category.

We also sorted the Guatemala sample after it had been aged for about 1 year. This coffee was easily separated by the UV sorter into 3 categories, consisting of (1) a weak fluorescence, (2) a bright fluorescence, and (3) a non-fluorescent category. A recent Mexican plumas coffee was also sorted, but only faint traces of fluorescence were found on about 15% of the beans. Samples of these beans are shown in the next slides, first under room light, then UV light. They are considered to be high quality arabicas.

The results of the cupping for all these coffee samples is shown on Table 1 (next slide). Looking at the comments under the CUP column you can see that all the sorted samples were essentially identical, although as stated in the footnote under Table 1, only the most experienced taster noted slight variations in the cups.

TABLE I

SOURCE	SAMPLE	SORT CRITERION	CUP **	pH
Burundi	1	Fluorescent	Good;mild	4.95
"	2	Non-fluorescent	Good;mild	4.86
"	3	Mix of 1 & 2	Good;soft #	4.82
Guatemala	1	Dim Fluorescence	Good;slightly sharp	4.55
"	2	Non-fluorescent	Good;trace of molasses	4.75
"	3	Bright Fluorescence	Good;mild;soft	4.74
Mexico	1	Non-fluorescent	Good;rich	NA
"	2	Trace fluorescence	Good;rich	NA

All sample brews measured between .8% and 1% solubles.

**Comments included of all tasters. Only one taster (highly experienced) could detect the slight differences between samples, and it was his opinion that roasting variations probably accounted for most of the flavor differences he detected.

Combining equal amounts of the Burundi cups 1 & 2 produced a mix which all tasters agreed was better balanced and more "interesting".

Conclusion

From these experiments it is clear that the fluorescence sorter has sufficient sensitivity and discrimination power to allow a separation of beans which differ slightly in their fluorescent emission. We conclude that, based on these cupping results, UV sorting of green coffee is not economically justified.

Also, we concluded that the UV sorters could be used to remove beans which failed to polish, because the onion skin blocks the UV light, thus preventing fluorescent emission. This would be done for cosmetic reasons, not to improve taste. Onion skin residues are present even in polished coffee and thus were included in our cup tests.

Finally, the possibility exists that in some producing areas, picking or processing practices may produce a number of poor beans which are distinguishable by a unique fluorescent spectral emission or irradiance. In this case, a fluorescent sorting operation may be justified if it is impossible to improve the practices which contribute to poor quality. It is suggested that a producer who is considering any type of quality control operation, especially fluorescence sorting, should specify a particular sorter only after cupping the sorted coffee to validate the sorting criteria.

References

Coffee Technology, Sivetz and Desrosier, AVI Publ. 1979, p. 185-190.

Color in Business, Science and Industry 3rd Ed. Judd & Wyszecki, Wiley, 1975 p. 219-234

AMÉLIORATION DANS LE TRAITEMENT DES RÉCOLTES DE CAFÉ (APPLICATION AU CAFÉ ARABUSTA)

J.-C. VINCENT, M. JACQUET

Laboratoire de chimie-technologie de l'IFCC

B.P. 5035, 34032 Montpellier cedex

INTRODUCTION

Durant de nombreuses années les progrès réalisés dans le matériel de traitement après récolte ont été discrets du fait de la faible taille des exploitations dans lesquelles le café est traité par voie humide.

La voie sèche, si elle exige peu de matériel même dans les exploitations de grande taille nécessite de grandes surfaces d'aires cimentées puisque le séchage solaire est généralement appliqué. Le séchage artificiel peut être envisagé dans les régions pluvieuses mais les contraintes thermodynamiques sont cependant sévères car l'application d'une température trop élevée durant la phase humide du séchage entraîne de profondes modifications de goût.

Les conditions socio-économiques des pays producteurs ont cependant bien changé, notamment en Côte d'Ivoire, aussi au cours de ces dernières années, la technologie du café fut confrontée avec divers problèmes posés notamment par :

- 1°/ - Le traitement après récolte de l'hybride Arabusta riche en pulpe qui peut difficilement être préparé par voie sèche vu la longue durée du séchage solaire.
- 2°/ - Le conditionnement industriel des cafés Robusta qui exige un matériel à débit important.

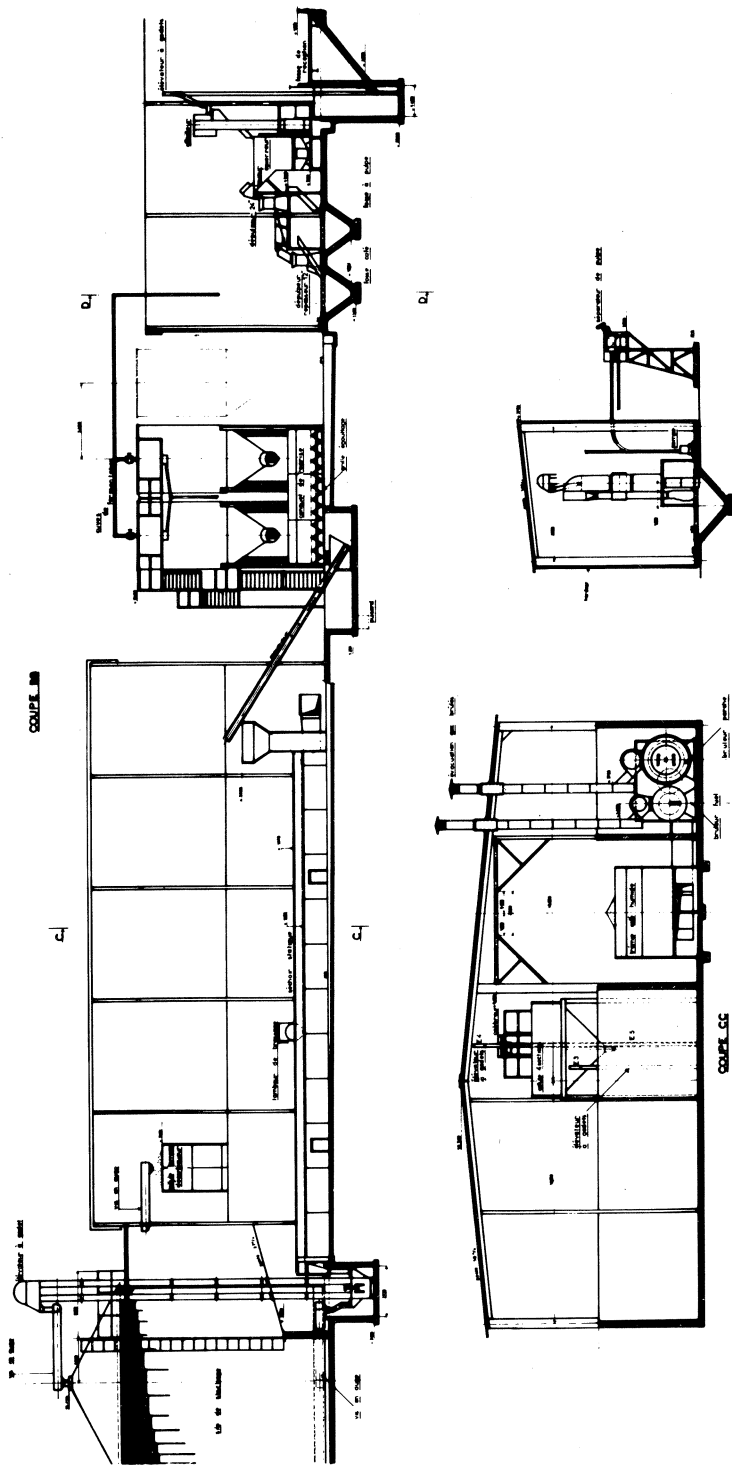

FIG. 1 - Schéma général de l'usine de traitement du Café Arabusta par voie humide implantée à SOUBRE (Côte d'Ivoire)

3°/ - L'utilisation des sous-produits résultant des méthodes de préparation par voies sèche et humide dans le sens de la récupération de l'énergie.

1. - AMELIORATION TECHNOLOGIQUE DU MATERIEL DE TRAITEMENT PAR VOIE HUMIDE EN PLANTATION.

L'hybride Arabusta implanté en Côte d'Ivoire est particulièrement riche en pulpe ce qui rend difficile le séchage solaire, souvent très long, même en période d'ensoleillement favorable ; aussi des goûts particuliers apparaissent sur la liqueur notamment le goût de "pruneau" (dried plum).

La voie humide paraît pratiquement obligatoire pour des raisons technologiques d'une part et qualitatives de la liqueur finale d'autre part.

La ligne de traitement fonctionnant au Centre d'étude et de développement de l'Arabusta à Soubré en Côte d'Ivoire (CEDAR) a été conçue pour traiter 7 5 0 T de produit marchand soit encore 5 2 5 0 T de cerises par campagne. Compte tenu d'une journée de pointe de récolte estimée à 2 % de la récolte totale il fallait prévoir de nettoyer, dépulper, fermenter et sécher le café sur la base de 1 0 5 T de cerises/jour.

Le procédé utilisé est classique et comprend : séparation des feuilles et branchettes, lavage des cerises avec épierrage, dépulpage, fermentation et séchage mais pour traiter de telles masses, divers appareils nouveaux ont été installés. Nous pouvons voir sur la figure n° 1 le schéma général d'implantation de cet atelier.

La fosse de réception est surmontée d'une grille permettant d'éliminer les matières étrangères de gros calibre. Les cerises sont reprises par un élévateur à godets qui alimente le premier appareil d'épuration des feuilles et des branchettes : l'effeuilleur.

Ces impuretés légères sont entraînées par un violent courant d'air ascendant produit par un ventilateur centrifuge dans une colonne à section rectangulaire. Il s'agit d'un catador adapté aux cerises de café dans lequel la vitesse de l'air a été augmentée compte tenu de la taille de particules et de leur humidité superficielle.

Après effeuillage, les cerises sont lavées et débarrassées des impuretés lourdes dans un épierrure fonctionnant sous eau.

Les cerises sont plongées et entraînées dans un courant d'eau ascendant produit par un agitateur à hélice alors que les impuretés lourdes sont décantées et recueillies à la base de l'appareil qui est nettoyé en fin de journée. Elles sont reprises par une chaîne à barreaux cylindriques et entraînées dans les dépulpeurs à cylindres ou à disques munis chacun d'un repasseur.

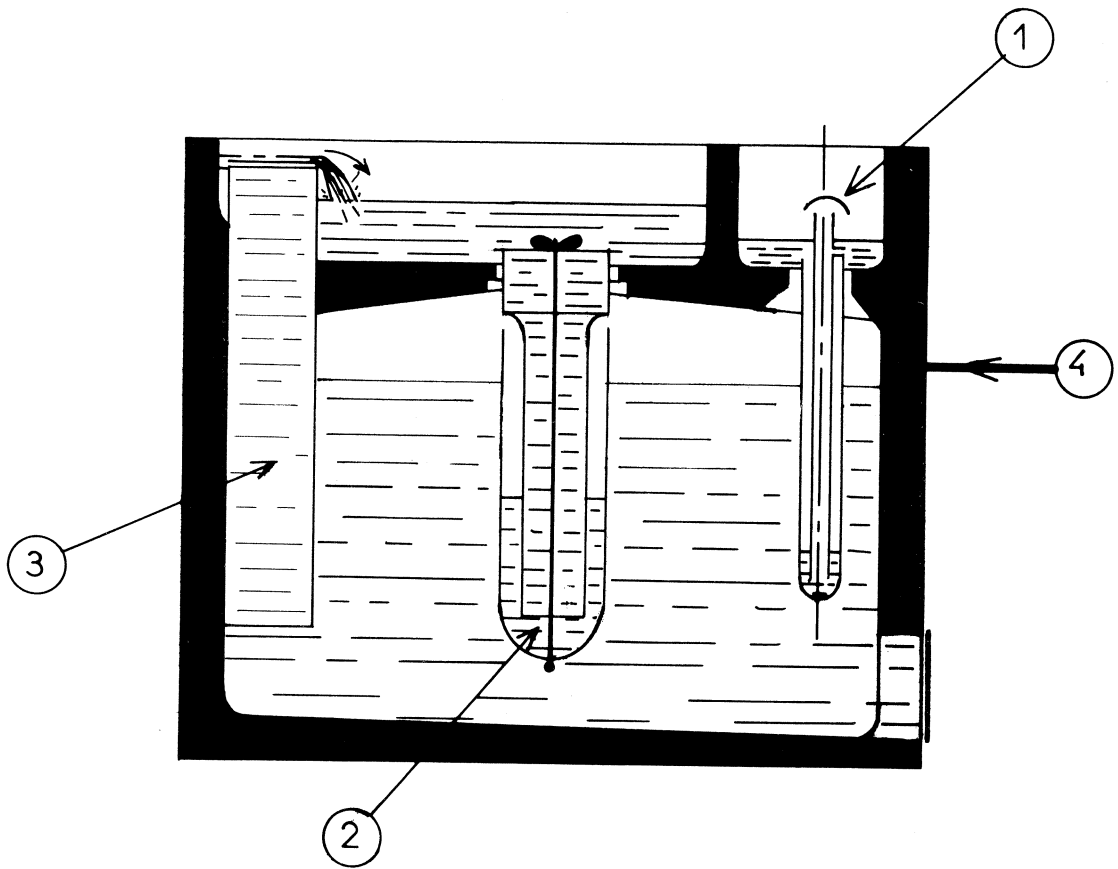

1° Phase - Remontage du mélange café + eau dans le cuveau supérieur

- ① VALVE HYDRAULIQUE
- ② LESSIVEUR
- ③ COLONNE DE REMONTAGE
- ④ ARRIVÉE D'AIR

Fig. 2. Principe de fonctionnement des cuves de fermentation du café en parche

2° Phase - Le cuveau supérieur est plein

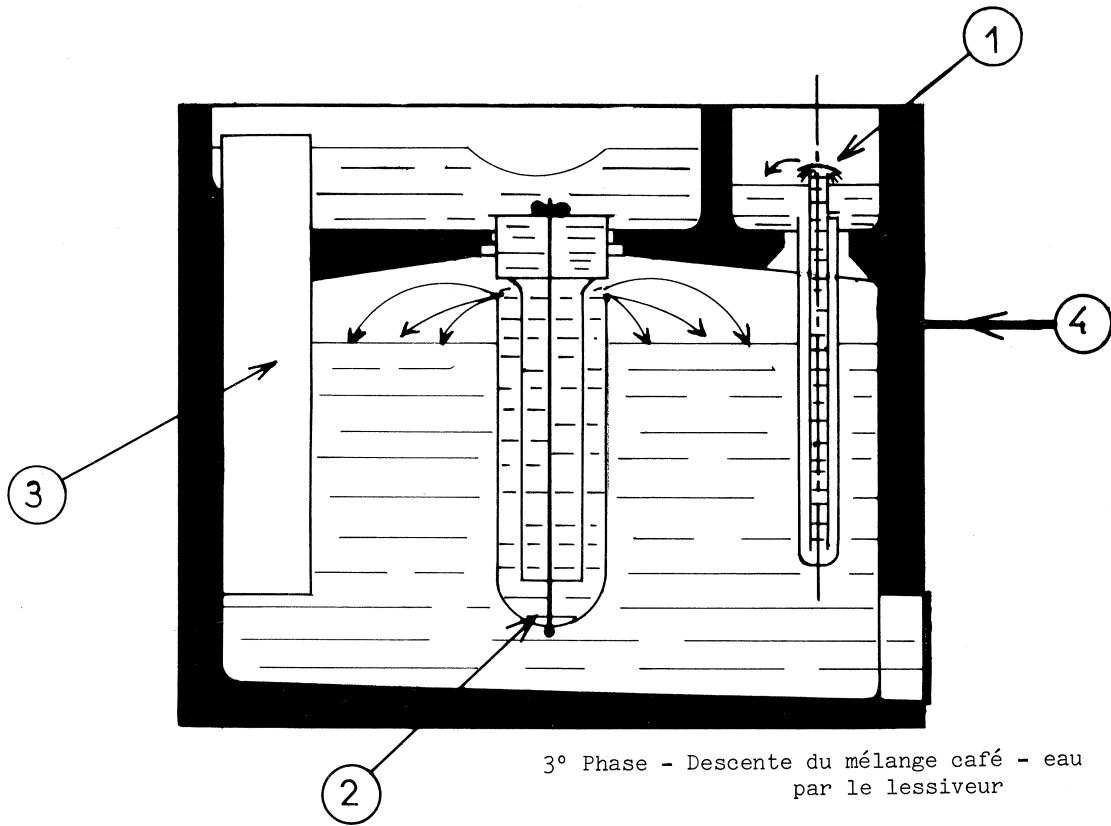
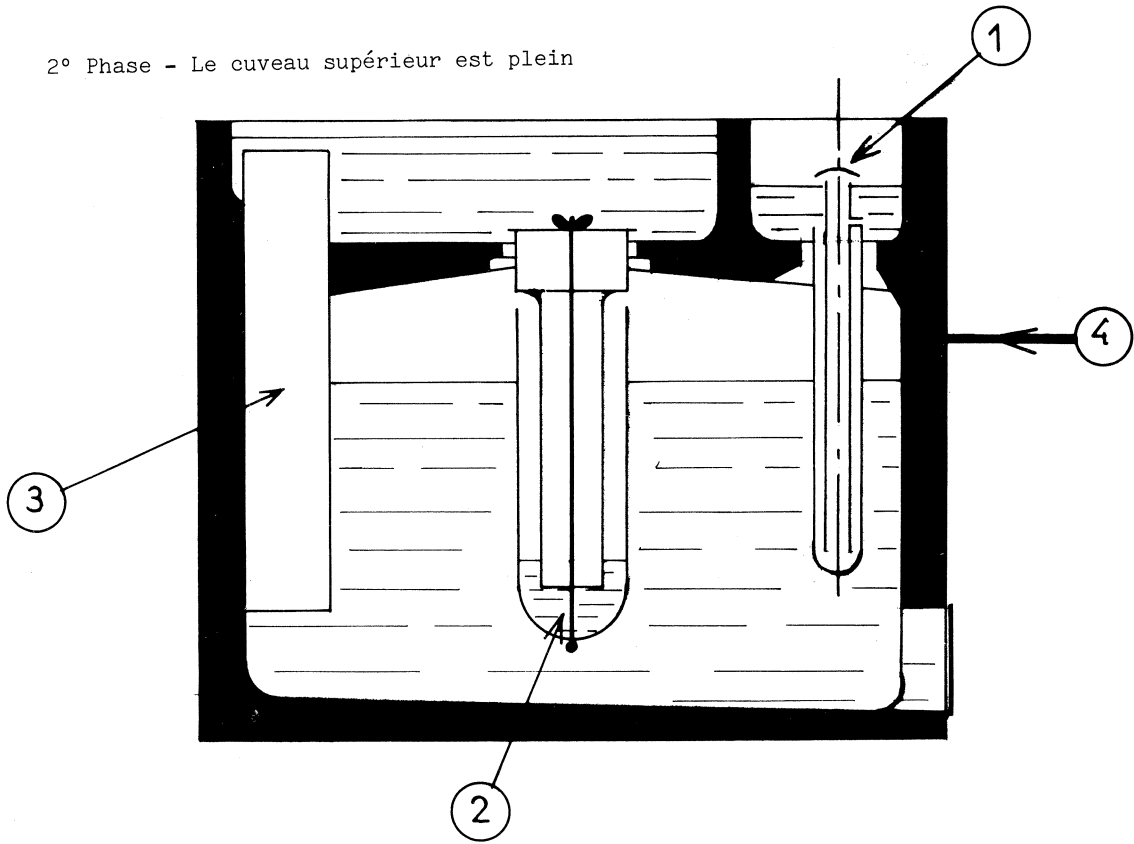

3° Phase - Descente du mélange café - eau
par le lessiveur

Les tables de séparation constituées par des tamis vibrants sont en général trop courtes pour permettre une discrimination suffisante entre pulpes et grains de café en parche. C'est le cas tout particulièrement pour l'Arabusta riche en pulpe et on peut constater la trop grande quantité de pulpe qui progresse simultanément avec le café en parche.

La pulpe est éliminée à l'aide d'une pompe à pistons et séparée de l'eau d'entraînement dans une courte vis tournant dans un carter à paroi cylindrique perforée.

Le café en parche est lui-même repris par une pompe à piston et pulsé vers les cuves de fermentation métalliques (inox ou revêtement époxy). Dans ces cuves on réalise l'élimination du flottant à l'aide d'un trop plein au niveau supérieur ; l'accélération de la dégradation du mucilage (opération de pectinolyse) grâce au frottement des particules entre elles lors du lessivage brutal occasionné par le passage de cette masse de la cuve dans le cuveau supérieur et surtout lors du transport du cuveau supérieur vers la cuve par l'étranglement que constitue le lessiveur ; la diffusion des polyphénols et diterpènes solubles dans l'eau ; le lavage du café en parche par renouvellement de l'eau propre ; l'élimination des eaux usées. Cette cuve constitue la partie la plus novatrice de l'installation, et on peut suivre son fonctionnement sur le schéma. Elle est divisée en 2 parties :

La cuve proprement dite où le produit est généralement stocké et le cuveau supérieur où le produit ne reste que temporairement lors des remontées.

Ces remontées sont provoquées par une augmentation de pression de l'air dans la cuve principale à l'aide d'un petit compresseur, la quantité de gaz produite par la fermentation n'étant pas suffisante.

Pour une pression donnée la soupape s'ouvre et le produit peut être entraîné par le courant ascendant qui naît du fait de la différence de pression. Le café remonte par le tube central et est distribué dans le cuveau supérieur après projection sur le chapeau qui coiffe le tube de remontée. Une fois le cuveau rempli, c'est la valve hydraulique qui va déclencher l'ouverture et donc le passage rapide du café du cuveau vers la cuve principale au travers de l'étranglement du lessiveur qui "pulvérisé" ainsi le produit. Cette action mécanique vient donc en aide à la pectinolyse enzymatique du mucilage par simple frottement des particules entre elles en détachant continuellement les fractions du mucilage. La durée de la fermentation est approximativement de 20 heures (minimum 16 heures) dans les conditions locales ivoiriennes.

Grâce au système de remontage pneumatique, les lavages sont aisés et les eaux usées sont facilement rejetées par la vanne de sortie.

Le café fermenté est sorti de la cuve par gravité et tombe dans un conquet muni d'une vis sans fin permettant d'acheminer le produit vers un séchoir statique horizontal à courant croisé muni d'un chariot remueur et déblayeur. La chaleur nécessaire est fournie à partir de la combustion du bois et de la parche et en complément un brûleur au fuel est installé parallèlement au brûleur à bois.

2. - AMELIORATION DU MATERIEL DE CONDITIONNEMENT

L'implantation de centres importants de décortilage et de conditionnement a entraîné le développement de matériel mieux adapté au traitement industriel du café.

En ce qui concerne ce sujet, M. RICHARD avait exposé, lors du précédent colloque, les progrès réalisés dans le traitement et le conditionnement des cafés verts en Côte d'Ivoire.

Depuis cette époque, de nouvelles unités de décortilage et de conditionnement ont été construites et des solutions techniques ont été trouvées pour satisfaire aux contraintes des lignes à gros débit.

- les réseaux de dépoussiérage se sont considérablement renforcés et les conditions de salubrité se sont très fortement améliorées.
- les appareils de nettoyage, largement dimensionnés, sont pourvus d'un capot hermétiquement fermé avec un système d'aspiration des poussières.
- le débit des décortiqueurs a été multiplié par 5 ou 6 dans les nouveaux appareils mis au point récemment avec une puissance proportionnellement moindre par tonne traitée. Le principe est basé sur un rotor constitué par des couteaux en rotation dans une cage (stator) en tôles perforées et munies de relief ou équipés de barreaux. Le débit peut ainsi atteindre 5 à 6 T/heure de café décortiqué avec une puissance de 30 CV.

Le mélange de coques brisées et de grains passent au travers de la cage et la séparation doit être réalisée dans un séparateur distinct.

Signalons encore des décortiqueurs ou départeurs fonctionnant selon le principe de la projection des particules contre une paroi fixe et sur celui de la compression suivie d'une décompression brutale.

- L'utilisation des tables densimétriques s'est développée même dans les unités de traitement de taille moyenne vu la qualité du travail fourni par ce type d'appareil. Bien connues dans d'autres industries alimentaires elles étaient rarement installées dans les usines à café des pays producteurs.

Elles sont utilisées pour séparer les produits endommagés par les insectes, les déficiences physiologiques ou les déficiences technologiques mais également pour séparer les cerises non décortiquées lors du premier passage dans les décortiqueurs qui peuvent ensuite être recyclées. Précédées d'un calibrage des particules, ces appareils réalisent un travail de séparation extrêmement fin sur des grains ne présentant que de faibles variations de masse spécifique.

- L'augmentation du coût de la main-d'oeuvre et l'industrialisation ont accentué la pratique du triage colorimétrique électronique. Les débits deviennent élevés (plus de 100 kg/h soit 300 à 400 grains examinés par seconde et par canal) et malgré le prix élevé l'amortissement s'avère rapide. De nouvelles trieuses, examinant le produit sous lumière U-V, permettent à présent d'éliminer des grains à odeur désagréable qui visuellement ne présentent aucune anomalie morphologique.
- Malgré le développement technologique de ces dernières années, le transport est toujours effectué en sacs et il serait sans doute économiquement judicieux d'envisager le transport du produit de l'intérieur du pays vers les usines de conditionnement portuaires à l'aide de camions de type citerne par exemple.

3. - UTILISATION DES SOUS-PRODUITS

L'énergie qui peut être récupérée à partir des sous-produits est considérable et permet d'assurer le fonctionnement d'une usine de traitement. Ainsi une unité de traitement de 30.000 T de café vert obtenu par voie sèche, dispose également de 30.000 T de coques de café dont le pouvoir calorifique inférieur est de l'ordre de 3.700 Kcal/Kg.

On peut donc envisager de récupérer cette énergie sous différentes formes et par divers moyens :

- Production d'air chaud dans des chambres de combustion pour l'alimentation des séchoirs.

Au Brésil existe un séchoir de faible capacité (100.000 Kcal/h) utilisant les coques de café comme combustible.

En collaboration avec les Etablissements PILLARD, un brûleur à lit tournant a été mis au point et assure la fourniture d'environ 1.000.000 Kcal/h.

L'air préchauffé par passage dans la double enveloppe est aspiré par le ventilateur qui assurera le transport du sous-produit (organe déprimogène) de la trémie vers le brûleur et l'injection dans la chambre de combustion tangentielle à la paroi constituée par des réfractaires en CSi.

- Utilisation dans la filière classique foyer - chaudière - turbine - alternateur. Des difficultés apparaissent (envolées, cendres à haute teneur en K d'où les grilles deviennent fusibles) mais c'est surtout le coût élevé de l'investissement de cette chaîne qui n'a pas permis la multiplication de ce système classique. (Prix des petites turbines proportionnellement très élevé).
- Production de gaz pauvre (1.200 Kcal/Nm³) constitué approximativement par :

H ₂	6	à	10	%
CO	16	à	21	%
CH ₄	2	à	5	%
C ₂ H ₄	0,8	à	1,6	%
CO ₂	13	à	9	%
N ₂	60	à	53	%

Ce gaz pauvre est produit dans des gazogènes à lit fixe ou "en suspension" à condition que le combustible ne dépasse pas 25 % de teneur en eau.

Le gazogène à lit tournant comprend :

- Une paroi intérieure cylindrique horizontale comportant des orifices tangentiels dans laquelle est créé un effet cyclonique intense entraînant les coques en rotation à grande vitesse par l'injection d'air et le recyclage partiel du gaz.
- Une double paroi de recirculation alimentée par un moto-ventilateur de recyclage des gaz de pyrolyse.
- Un dispositif de dosage et d'alimentation des coques.
- Une torche d'allumage à gaz riche (butane ou propane)

La température du gaz à la sortie du gazogène est d'environ 700° C avant l'échangeur et 400° C après échangeur gaz/air.

Dans le schéma de principe présenté, le gaz est utilisé pour alimenter un moteur (à gaz ou dual - fuel). La chaîne nécessite dès lors tout le système de lavage et filtrage et refroidissement des gaz avant pénétration dans le moteur qui entraîne un alternateur.

On peut prévoir d'autres utilisations possibles des gaz notamment dans un brûleur à gaz pauvre ou mixte gaz pauvre/fuel oil monté sur chaudière ou séchoir. Cette solution très simple a l'avantage de s'adapter sur des générateurs existants moyennant transformation du brûleur existant. On peut également envisager l'utilisation d'une turbine à gaz. L'ordre de grandeur de production d'énergie mécanique à la sortie de l'arbre d'un moteur à gaz pauvre est 1 KWH par kg de matière à 8-15 % de teneur en eau. L'ordre de grandeur de production de gaz est d'environ 2,7 kg de gaz à 1225/1400 Kcal/Nm³ par kg de matière à 8 - 15 % de teneur en eau.

La gamme des appareils actuellement disponibles comprend des appareils de débit allant de 100 à 1500 kg/h de matière.

Le gazogène à lit fixe nécessite le compactage préalable des coques sous forme de pellets.

- La fabrication de charbon de bois à partir de parches de café a été envisagée et étudiée en particulier au Kenya où le sous-produit est pyrolysé dans un four continu auto-entretenu par les gaz de distillation ; il est ensuite broyé, homogénéisé et compacté en pellets qui brûlent lentement et sans dégagement de fumée.
- La pulpe fait actuellement l'objet de recherches pour la production de gaz méthane et dans cette assemblée quelques membres présentent des travaux qui laissent espérer d'une part la récupération de gaz riche (6000 kcal/Nm³) et d'autre part la fourniture d'un compost qui sera restitué au sol.

*

* *

En conclusion, nous pouvons constater que des progrès récents ont été réalisés en technologie du café mais de nombreux objectifs doivent encore être atteints. Il ne faudrait toutefois pas négliger la qualité du produit et penser que toute cette technologie nouvelle éliminera les précautions à prendre lors de la préparation en plantation. Il n'en est rien ; le producteur reste celui dont dépend cette qualité organoleptique si recherchée ; par la suite la technologie ne pourra qu'éliminer les défauts et il est certainement moins onéreux de les éliminer sur les lieux de production. Je tiens à insister particulièrement sur ce point car trop souvent on se base sur une technologie de pointe pour croire à l'amélioration d'un produit alors que des traitements simples et nécessitant peu d'investissement la fixent définitivement. Mais il s'agit sans doute là d'une question commerciale.

THE UTILITY OF CHEMICAL ENGINEERING PRINCIPLES IN COFFEE-PROCESSING TECHNOLOGY

C. JUDSON KING

Professor & Chairman

Department of Chemical Engineering

University of California

Berkeley, CA 94720 U.S.A.

INTRODUCTION

Coffee processing has developed over the years into a complex and multi-faceted technology (Sivetz and Desrosier, 1979). The product trades on its organoleptic properties, among which flavor and aroma are highly important. It has been well established for many years that these properties can be strongly influenced by changes in processing methodology and operating conditions. Yet only recently has much been done to develop a fundamental, mechanism-oriented understanding of the ways in which processing operations affect product quality. Such an understanding is probably the most effective route to process innovation and improvement. The principles required for mechanistic understanding fall very much within the domain of Chemical Engineering, since they are drawn from the fields of transport, phase-equilibrium thermodynamics, and reaction kinetics.

The purpose of this paper is to outline some of the ways in which the principles of Chemical Engineering and allied disciplines are useful for generating an improved fundamental, mechanistic understanding of various aspects of coffee processing. I will start by outlining some places where selective mass transport is of critical importance in determining quality attributes. Two specific examples of this come from the manufacture of instant coffee; a third comes from decaffeination. I will then describe several aspects of the recent research in our own group at Berkeley, all of which involve deployment of principles of transport and phase-equilibrium thermodynamics to gain mechanistic insight into phenomena that are important for coffee processing. These include volatiles retention in spray drying, changes in particle morphology occurring during spray drying, and volatiles retention in freeze drying.

SELECTIVE MASS TRANSPORT

There are a number of instances in coffee processing where it is desirable to promote transport, or "mass transfer", of one or more substances out of a medium and/or into a second phase, while retarding transport of one or more other substances. The goal in such a case is selective transport of the first substance(s).

Three examples serve to illustrate the central importance of selective transport to coffee processing:

- (1) In extraction of coffee solubles from roast-and-ground coffee during manufacture of instant coffee, it is obviously desirable to maximize extraction of components which are important to the flavor and aroma and/or physiological attributes of instant coffee, while minimizing extraction of substances which are deleterious to product quality. This makes for a product with more consumer appeal and economic potential. The problem is compounded by the fact that both desirable and undesirable substances have appreciable water solubility.
- (2) In concentration and drying of instant-coffee extract, it is important to find ways of selectively removing water, without the loss of other constituents which are important to flavor and aroma and/or other aspects of product quality. This follows since water will be the one chemical component added upon reconstitution, and it is generally accepted that a desirable goal is for the reconstituted product to be as indistinguishable as possible from the original extract or from ordinary brewed coffee. The principal complicating factor here is that evaporation is the most commonly used method of water removal, and most flavor constituents and all aroma components have very high volatilities in aqueous coffee solutions.
- (3) In decaffeination of coffee, it is imperative to avoid product contamination from solvents or other substances which affect taste or aroma, or are suspected of being physiologically harmful. Caffeine should be removed somehow through a mass-transfer process without this contamination and without simultaneous removal of flavor and aroma compounds and/or other substances critical to product quality. Furthermore, there is substantial economic incentive for isolating caffeine in a form that is sufficiently pure for marketing purposes.

In all of these examples, it is desirable to transfer one or more components (coffee solutes, water, or caffeine) from one medium to another, while preventing or impairing removal of other substances (less desirable solutes, flavor and aroma substances, or other quality factors) and addition of contaminants.

There are two basic ways in which selective transport can be achieved. One is by identifying a partitioning separation process [also known as an "equilibration" separation process (King, 1980)] for which the phase-equilibrium relationship is sufficiently selective. Thus, for example, freeze concentration is effective as a concentration process for coffee extract before freeze drying because it is a separation process based upon the formation of ice as a second phase for water removal. Since ice excludes most other substances from the crystal structure, water removal as ice serves to keep nearly all of the flavor and aroma components in the concentrated extract. Similarly, a solvent with a very high solubility for caffeine and a very low solubility for everything else has been a perennial goal of decaffeination research. The ultimate attractiveness of carbon dioxide as a successor solvent to chlorinated hydrocarbons for decaffeination hinges upon its equilibrium selectivity for extraction of caffeine over other substances of importance, notably flavor and aroma constituents.

Because of the very large number of constituents present in coffee and in coffee extracts, there are relatively few instances where it is possible to ensure selective removal of a single substance on the basis of phase-equilibrium properties alone.

The other way in which selective transport can be achieved is through rate effects. It has often been observed that caffeine is extracted relatively rapidly from roast-and-ground or green coffee in comparison to other substances of importance. This affords another avenue toward selective decaffeination. Cell-wall membranes in the coffee bean allow solutes to pass through at different rates. This factor allows some solutes to be removed more rapidly than others of equivalent ultimate solubility. This may be one reason for the common impression that the quality of drip coffee is superior to that of percolator coffee. Temperature control affords another means of influencing the relative permeability of the cellular material toward different solutes. Factors governing rates of extraction, or leaching, from solid food materials have recently been reviewed by Schwartzberg (1980).

A major advance in the understanding of aroma loss and means for aroma retention during concentration and drying was the introduction of the selective-diffusion concept by Thijssen and co-workers (Thijssen & Rulkens, 1968). More recent applications of this concept have been reviewed by King (1971), by Bomben, et al (1973), and in a presentation by Kerkhof (1977) at the last previous ASIC Colloquium. The basic discovery is that the diffusion coefficients of volatile organic compounds in carbohydrate solutions tend to become much less than the diffusion coefficient of water as the concentration of carbohydrate solutes increases to high values. If the surface of a drop or other isolated mass of solution can be made to achieve a high carbohydrate-solute content early in a concentration or drying process, it will serve as an ultrasensitive barrier -- allowing water to diffuse through at an acceptable rate, but cutting the rate of diffusion of other volatile substances down to very low values. Such a selective surface layer serves to give excellent volatiles retention once it is formed. One of the main barriers to the use of reverse osmosis as a concentration process for coffee extract and other food liquids has been the difficulty of locating or creating a natural or artificial membrane with similarly good selectivity properties.

If substances such as volatile flavor and aroma components cannot be effectively retained during processing, one must then consider means for recovering those substances somehow and adding them back. Some of the approaches for doing this were reviewed by Bomben, et al (1973). In general it is far preferable to retain such components during processing rather than instituting processing schemes for recovering them.

I would like now to proceed to a presentation of some of our recent research results at Berkeley, which use chemical-engineering principles to achieve a mechanistic understanding of processing steps.

VOLATILES RETENTION IN SPRAY DRYING

Spray drying is a relatively inexpensive and reliable dehydration process, but it has suffered from problems of poor retention of volatile flavor and aroma substances. There have been previous studies directed toward analyzing the mechanisms of volatiles loss in spray drying (Rulkens & Thijssen, 1972; Kerkhof & Thijssen, 1977; etc.). However, these did not involve experiments where liquid samples were obtained locally within the dryer. In work at Berkeley we have constructed a sampling probe capable of gathering accurate samples of drops locally within a spray chamber at locations near the atomizer (Kieckbusch & King, 1977). We have used this device to measure losses of volatile n-acetates (ethyl, propyl, butyl, pentyl) during spray drying of aqueous sucrose solutions. Vapor-liquid equilibrium data have also been measured for these systems (Kieckbusch & King, 1979), so as to facilitate interpretation of the volatiles-retention results.

Typical results for axial sampling with a full-cone spray from a pressure nozzle are shown in Figures 1 and 2 (Kieckbusch & King, 1978). As these figures show, there are quite large losses of the volatile compounds at relatively short distances from the atomizer where the percent water evaporation is still low, even for 40% w/w sucrose solution. Furthermore, the relative positions of the retention curves for different acetates allow one to identify the relative influences of gas- and liquid-phase resistances to mass transfer. This follows from the addition-of-resistances concept for

Figure 1. Retention of n-Acetates and % Evaporation vs. Distance from Atomizer for 40% w/w Sucrose Solution Fed and Axial Sampling.

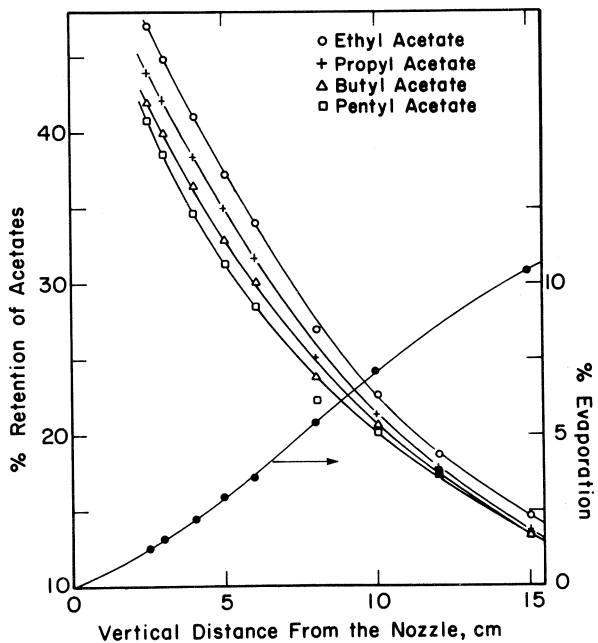
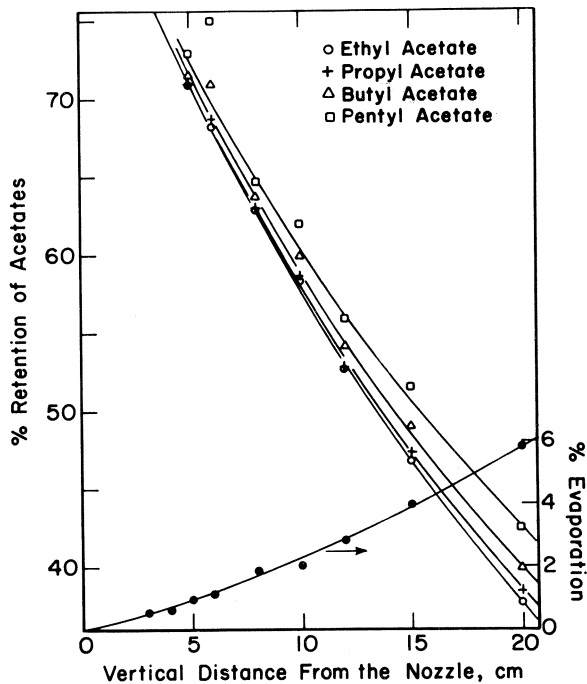

Figure 2. Retention of n-Acetates and % Evaporation vs. Distance from Atomizer for 1% w/w Sucrose Solution Fed and Axial Sampling.

mass transfer:

$$\frac{1}{K_L} = \frac{1}{k_L} + \frac{1}{Hk_G} \quad (1)$$

Here K_L is the overall liquid-phase mass-transfer coefficient, based upon a driving force which is the difference between the solute concentration in the bulk liquid and the solute concentration which would be in equilibrium, locally, with the gas phase. k_L is the individual liquid-phase mass-transfer coefficient, based upon a driving force which is the difference in solute concentration between bulk and interface liquid. k_G is the individual gas-phase coefficient based upon a driving force which is the difference in solute partial pressure between interfacial and bulk gas, and H in the Henry's Law constant -- the reciprocal solubility of the solute in question. Percent losses of volatile substances from the sprayed liquid increase with increasing K_L . When liquid-phase resistance to mass transfer is rate-limiting, the $1/k_L$ term dominates, and K_L is proportional to k_L which, in turn, increases with increasing solute diffusivity in the liquid phase. Among the acetates, ethyl has the highest diffusivity and pentyl the lowest; hence, for liquid-phase control, the retention of pentyl acetate should be highest, and that of ethyl acetate should be the lowest, as occurs, for example, in Figure 1.

When gas-phase resistance to mass transfer is rate-limiting, the $1/(Hk_G)$ term in Equation 1 dominates. H increases substantially with increasing carbon number for the n -acetates (Kieckbusch & King, 1979), reflecting very large increases in activity coefficient as the molecular weight and non-polar character become greater. This effect outweighs the effect of gas-phase diffusion coefficient on k_G , and so K_L tends to be highest for pentyl acetate and lowest for ethyl, making the retention highest for ethyl acetate and lowest for pentyl acetate. This ordering is opposite to that for liquid-phase control, and can be seen at shorter distances from the nozzle in Figure 2.

The results of our retention experiments for different acetates show a tendency toward gas-phase control very close to the nozzle (e.g., in the expanding film from a pressure atomizer before drop break-up) and for dilute solutions. There is strong liquid-phase control both for more concentrated solutions and further from the nozzle.

We have also modeled volatiles losses quantitatively, using the differential equations of transport. The spectrum of drop sizes from a typical atomizer is sufficiently wide so that it is desirable to allow for the different behaviors of drops in different size ranges (Zakarian & King, 1980). The transport model is able to match the experimentally observed retentions relatively well in the region near the nozzle. Table 1 gives the predicted losses of ethyl acetate from 40% w/w sucrose solutions due to different mechanisms during the first 16 cm from the nozzle, for the conditions of our experiments.

In other recent work we have investigated the effect of an emulsified oil phase on the retention of the same volatile acetates in sucrose solutions, again in the region close to the nozzle (Zakarian and King, 1980). One primary effect of the added oil phase for a pressure nozzle is to cause earlier break-up of the expanding film into drops. This increases the average drop size and widens the drop-size distribution. Another important effect comes from extraction of volatiles into the oil phase. This occurs because of the very high equilibrium distribution coefficient into the oil phase, which stems again from the high activity coefficient in the aqueous phase. We have obtained phase-equilibrium data for the series of acetates between vegetable oils and aqueous solutions of sucrose (Kieckbusch & King, 1979), and have employed these data to interpret the increased retentions of the higher acetates in the presence of up to 0.8% w/w added oil. As an example, 0.37% emulsified peanut can increase the retention of pentyl acetate in 40% w/w sucrose solution 18cm from the nozzle from 60% to 78%.

TABLE 1.

Predicted Losses of Ethyl Acetate from 40% w/w Sucrose
Solution, Using Mass-Transport Analysis (Zakarian & King, 1980)

(Fan-spray nozzle, pressure = 790 kPa)

<u>Mechanism</u>	<u>Loss, % of Original</u>
Expanding film, before breakup	10
Drop formation	7 - 15
Internal-circulation period	6
Stagnant-diffusion period (up to 16 cm)	<u>31</u>
TOTAL (up to 16 cm from nozzle)	54 - 62

Preferential extraction of volatiles into an emulsified oil phase can substantially increase the retention of those components during spray drying, but it should also be recognized that extraction into the oil phase in the reconstituted product will serve to suppress the equilibrium partial pressure of a volatile component above that solution and thereby decrease the aroma response per unit quantity of that component in the solution and oil, combined. This offsetting factor is less deleterious for a situation such as that for coffee, where the concentration of the reconstituted product is much less than the concentration of the extract fed to the spray dryer (King & Massaldi, 1974). One can have the situation where a component partitions substantially into emulsified oil in the extract concentrate, but partitions largely back into the aqueous phase when coffee is reconstituted in the cup, because of the much smaller ratio of oil to aqueous solution there.

Our work to date has involved pressure atomizers with relatively low nozzle pressures (790 kPa). Currently, we are exploring the effect of much higher nozzle pressures on volatiles retention near the atomizer, and are sampling at greater degrees of evaporation in an effort to monitor the approach toward the asymptotic retention predicted by the selective diffusion model of Thijssen and co-workers.

Processing implications from the results so far include:

- (1) A large amount of volatiles loss can occur in the region very near the nozzle;
- (2) In order to suppress this loss the rate of mass transfer in the liquid phase must somehow be influenced, and
- (3) An added oil phase can be beneficial for volatiles retention, but it can also increase both the average drop size and the spread of drop sizes.

PARTICLE MORPHOLOGY IN SPRAY DRYING

It has often been observed that particles of coffee extract and other food materials can take on very different shape and size characteristics, depending upon the conditions of drying. For some conditions (e.g., quite low air temperatures) particles shrivel and take on a raisin-like appearance. At the higher temperatures characteristic of most commercial dryers, particles develop internal voidage, and in some cases expand to volumes greater than the initial drop size. There have also been reports, e.g., for suspended drops of coffee extract (Charlesworth & Marshall, 1960), of particles cycling between periods of inflation and contraction during drying. These characteristics have much more than academic importance, since particle morphology governs the bulk density of the dry product and may affect reconstitution characteristics. Also, Rulkens and Thijssen (1972), and Kerkhof and Thijssen (1977) associated increased volatiles loss with particle expansion.

In recent work (Greenwald & King, 1980), we have used a vibrating-reed device to generate a single stream of uniform droplets, which fall through a column equipped with a slow purge of air. The walls of the column can be heated to different temperatures at different locations, so that the time-temperature history experienced by the falling drops can be adjusted and controlled. We are using this device in conjunction with optical and scanning-electron microscopy to observe the ways in which the time-temperature history, initial drop size, and solution composition and concentration cause changes in particle morphology during drying.

In studies with 20% w/w coffee extract, we have found conditions where some of the particles are inflated and others are shrivelled, as shown in Figure 3. Experiments in which inflated particles were broken open by mechanical action showed either a single, large internal void, or else a large void accompanied by multiple, smaller voids (see Figure 4).

Consideration of the possible mechanisms for formation of internal voids or bubbles for the conditions of these experiments led to the conclusion that bubbles are formed by internal desorption of dissolved air as the drop temperature increases (Greenwald & King, 1980). This desorption results from the decreased solubility of air at higher temperatures. These bubbles then grow by further desorption as temperature continues to increase further, as the solution concentration increases, and as the amount of liquid in the drop decreases. However, the bubble volumes should remain relatively small (a few percent of the drop volume, at most) until the temperature rises sufficiently close to 100°C for the equilibrium partial pressure of water vapor to rise to the point where the mole fraction of water vapor in the bubble approaches unity. Once the temperature becomes that high, inflation can occur. Thus, desorption of dissolved air is required for bubbles to form in the first place, and heating to near or above 100°C is required for substantial expansion of the drop to occur during drying. In cases such as Figure 3, where some particles expand and others with identical initial conditions do not, the inference is that nucleation of air bubbles occurred in only a fraction of the drops.

Figure 5 shows changes in drop diameter vs. height of fall for drops of 20% w/w coffee extract exposed to different temperature profiles. Expansion occurs earlier and to a greater extent for drops which are heated to a higher temperature during the fall, reflecting a more rapid increase in temperature to the 100°C level, with earlier inflation due to water evaporation into the internal bubbles. Points in Figure 5 denoted by triangles are cases where a range of particle sizes was observed, corresponding to different degrees of inflation for different particles.

Figure 6 shows observed effects of different initial drop diameters on expansion tendencies, for 20% w/w coffee extract with the same temperature profile in each case. Here smaller drops expand at shorter fall heights, because of more rapid drying and because of their lower terminal velocity.

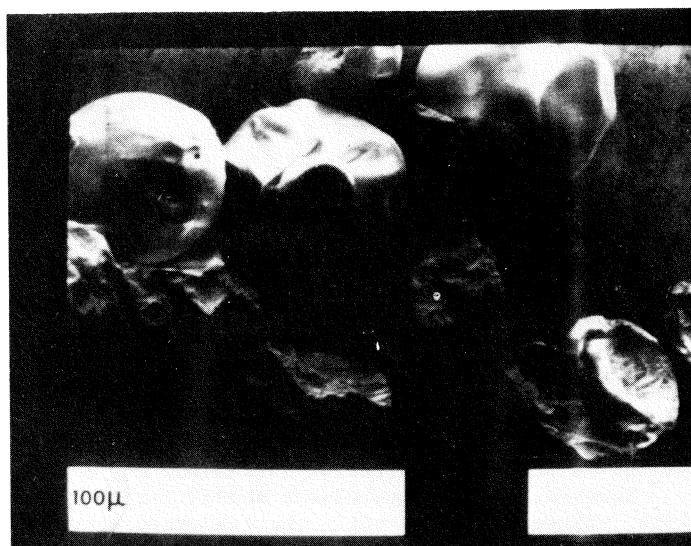
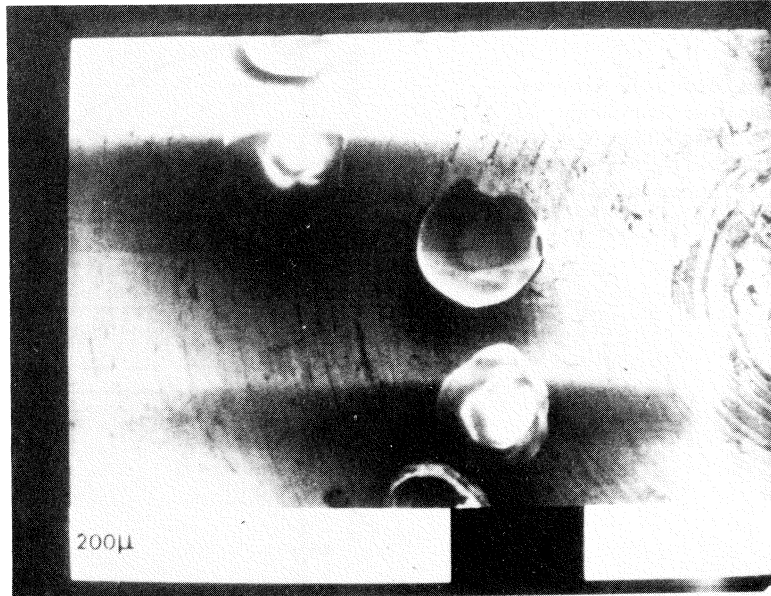
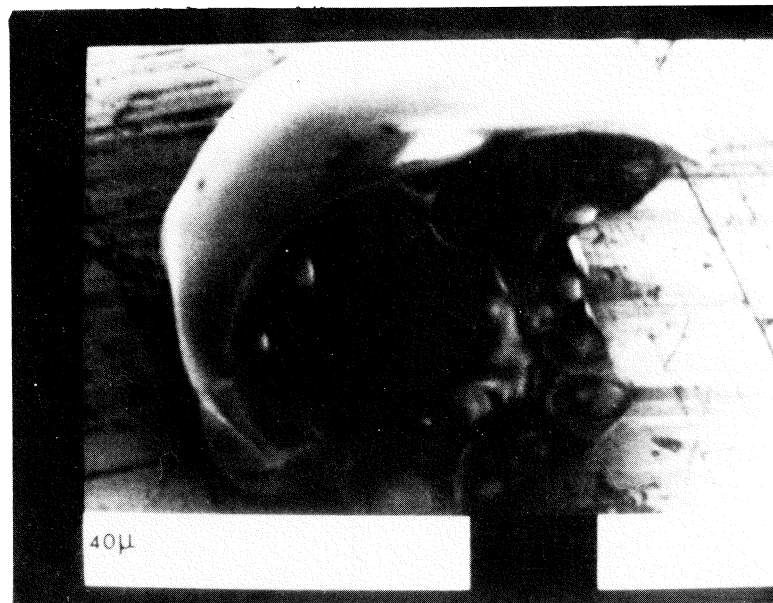

Figure 3. SEM Photograph of Coffee Particles Dried with Air Temperature Increasing to 125°C. Initial Diameter = 180 μm; Length of Fall = 2.28m. (This run is also represented in Figure 6.)



a. Hollow shell.



b. Multiple voids.

Figure 4. SEM Photographs of Fractured Coffee Particles Dried with Air Temperature Increasing to 135°C. Initial Diameter = 210 μm ; Length of Fall = 2.28m. (This run is also represented to Figure 5.)

Figure 5. Particle Size Changes Observed for Drops of 20% w/w Coffee Extract Dried with Air Temperature increasing to Different Levels.

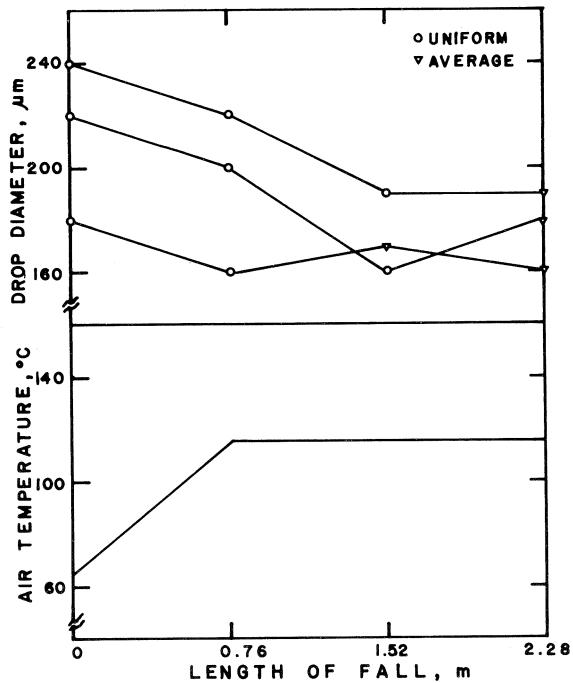
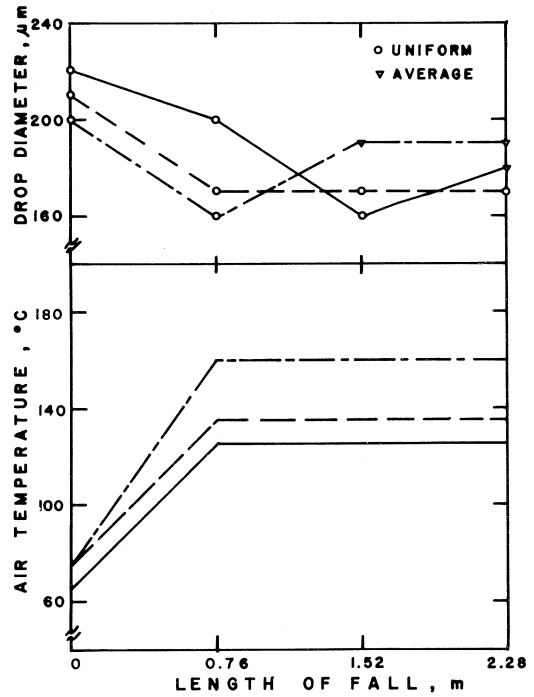

Figure 6. Effect of Initial Drop Size on History of Observed Sizes for Drops of 20% w/w Coffee Extract Dried with Air Temperature Increasing to 115°C.

The mechanism of air desorption for bubble formation within drops should occur as well for commercial spray dryers with pressure atomizers. The drops would initially reach the wet-bulb temperature and then subsequently increase in temperature as drying takes place.

Absorption of air should be very efficient in the region near the atomizer, for the same reasons that losses of volatiles near the atomizer are large. Hence, even if the liquid feed contains little or no dissolved air, it should approach saturation at the wet-bulb temperature soon after drop formation. The subsequent increase in drop temperature as drying occurs will then produce the driving force for air desorption and bubble formation. For rotating-disk (centrifugal) atomizers the mechanism of bubble formation may be different; Verhey (1972-73) postulates mechanical entrainment of air bubbles during drop formation for such atomizers.

VOLATILES RETENTION IN FREEZE DRYING

Freeze drying is expensive in comparison to spray drying, but it gives excellent retention of volatile flavor and aroma compounds if it is carried out under well chosen conditions. Coffee is, by far, the largest-volume freeze-dried product in the world today.

The volatiles-retention characteristics of freeze drying have been interpreted in terms of a diffusion model applied to the webs of interstitial concentrate left between subliming ice crystals (Thijssen & Rulkens, 1968; King, 1971). One simple approach (King, 1970, 1971) is to consider the dimensionless Fourier group Dt/L^2 , where D is the diffusivity of a volatile component within the interstitial concentrate, t is the time during which the web is exposed to vacuum before becoming so dry that the volatiles are in effect immobilized, and L is the average thickness of the concentrate webs. Solutions of the diffusion equation show that greater values of this Fourier group give greater percentwise loss of volatiles during freeze drying.

The directional effects on Dt/L^2 from variables such as freezing rate, extract concentration, drying rate and frozen-zone temperature during drying can be readily assessed. Comparison of these predicted effects with experimental measurements of volatiles retention during freeze drying gives good agreement.

In more recent work we have investigated the effect of an emulsified oil phase on volatiles retention during freeze drying. If the main constituent of the oil phase is itself volatile, the percent retention of it during freeze drying tends to be less than occurs when the concentration of the oil constituent is low enough for it to be fully in solution. This behavior has been attributed to a mechanism where oil drops initially in regions that are ultimately occupied by ice crystals after freezing are totally lost, because they accumulate at the ice-crystal surfaces and are vaporized after the ice crystal sublimates (Massaldi & King, 1974a). The percent loss of oil-phase volatiles thereby becomes equal to the volume percent ice present after freezing. Experimental results for retention of d-limonene emulsified in sucrose solutions during freeze drying tend to support this mechanism (Massaldi & King, 1974a). In orange juice the retention of d-limonene is often substantially higher than predicted by this mechanism, possibly because of a stabilizing effect from the "cloud" (Massaldi & King, 1974b).

For coffee extract, an emulsified coffee-oil phase would serve as a non-volatile extractant for coffee volatiles. In recent work (Etzel & King, 1980), we have measured the effects of a suspended vegetable-oil phase on the retention of volatile n-acetates during freeze drying of aqueous sucrose solutions. This system was chosen because of the availability of pertinent phase-equilibrium data, as noted earlier for spray-drying studies. Experimentally observed retentions as a function of carbon number of the acetate (ethyl, propyl, butyl, pentyl) are shown in Figure 7, for 25% w/w sucrose solution containing 0.5 and 1.0 % w/w emulsified peanut oil. The curves drawn in represent the predictions of a model based upon a theory whereby volatiles partition at equilibrium into the emulsified oil phase, and volatiles in oil drops located in regions ultimately

occupied by ice crystals after freezing are totally lost upon freeze drying. This analysis is completely analogous to that made earlier for the case where the oil itself is volatile. Percent retentions are lower for the higher acetates, because they partition to a greater extent into the oil phase.

ACKNOWLEDGEMENTS

Much of the research reported here from our own group was supported by the National Science Foundation (U.S.A.) through Grant No. ENG76-17270. In addition, two co-workers of the author received fellowship aid from General Foods Corporation and from Conselho Nacional de Desenvolvimento Cientifico e Tecnológico, Brasil.

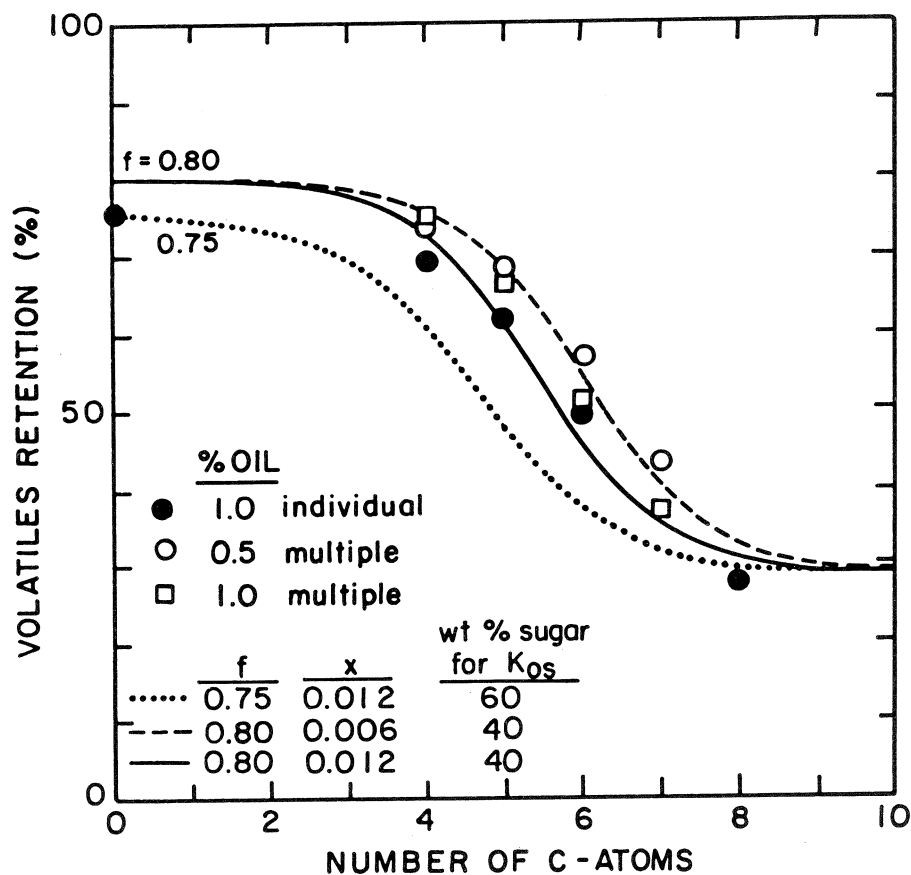

Figure 7. Observed Retentions of n-Acetates during Freeze Drying of 25% w/w Sucrose Solutions Containing 0.5 and 1.0% w/w Emulsified Peanut Oil. Curves are Predictions of Theoretical Model, for Various Values of Fractional Retention of Homogeneously Dissolved Volatiles (f), Volume Fraction Oil (x), and wt % Sucrose at Which Equilibrium Partitioning is Assumed to Occur.

REFERENCES

- Bomben, J. L., S. Bruin, H. A. C. Thijssen and R. L. Merson (1973). "Aroma Recovery and Retention in Concentration and Drying of Foods". Advances in Food Research, 20, 1.
- Charlesworth, D. H., and W. R. Marshall (1960). "Evaporation from Drops Containing Dissolved Solids". AIChE Journal, 6, 9.
- Etzel, M. R., and C. J. King (1980). "Retention of Volatile Components during Freeze Drying of Substances Containing Emulsified Oil". J. Food Technol., in press.
- Greenwald, C. G., and C. J. King (1980). "Particle Morphology in Spray Drying of Foods". pres. at Am. Inst. Chem. Eng. Meeting, Portland, OR, U.S.A. [See also, C. G. Greenwald, Ph.D. dissertation in Chemical Engineering, University of California, Berkeley, CA, U.S.A., 1980].
- Kerkhof, P. J. A. M. (1977). "Preservation of Coffee Aroma during the Drying of Coffee Extracts". pres. at 8th Intl. Sci. Colloq. on Coffee, A.S.I.C., Abidjan.
- Kerkhof, P. J. A. M., and H. A. C. Thijssen (1977). "Quantitative Study of the Effects of Process Variables on Aroma Retention during the Drying of Liquid Foods". AIChE Symp. Ser., 73 (163), 33.
- Kieckbusch, T. G., and C. J. King (1977). "Losses of Volatiles in the Nozzle Zone during Spray Drying". Proc. 2nd Pacific Chem. Eng. Congr., Am. Inst. Chem. Engrs., 1, 216.
- Kieckbusch, T. G., and C. J. King (1978). "Volatiles Loss during Atomization in Spray Drying". pres. at Am. Inst. Chem. Eng. Meeting, Miami Beach, FL, U.S.A. AIChE Journal, in press, 1980.
- Kieckbusch, T. G., and C. J. King (1979). "Partition Coefficients for Acetates in Food Systems". J. Agr. Food Chem., 27, 504.
- King, C. J. (1970). "Recent Developments in Food-Dehydration Technology". Proc. Third Intl. Congr. of Food Sci. & Technol., 565.
- King, C. J. (1971). "Freeze Drying of Foods". CRC Press, Chemical Rubber Publ. Co., West Palm Beach, FL, U.S.A.
- King, C. J. (1980). "Separation Processes," 2nd ed., McGraw-Hill Book Co., New York.
- King, C. J., and H. A. Massaldi (1974). "Aroma Preservation during Evaporation and Drying of Liquid Foods: Consideration of Mechanism and Effects of More than One Phase Being Present". Proc. IV Intl. Congress Food Sci. & Technol. (Madrid), 4, 183.
- Massaldi, H. A., and C. J. King (1974a). "Volatiles Retention during Freeze Drying of Synthetic Emulsions". J. Food Sci., 39, 438.
- Massaldi, H. A., and C. J. King (1974b). "Retention of d-Limonene during Freeze Drying of Orange Juice". J. Food Sci., 39, 445.
- Rulkens, W. H., and H. A. C. Thijssen (1972). "The Retention of Organic Volatiles in Spray Drying Aqueous Carbohydrate Solutions". J. Food Technol., 7, 95.

REFERENCES

- Schwartzberg, H. G. (1980). "Continuous Countercurrent Extraction in the Food Industry". Chem. Eng. Prog., 76 (4), 67 (1980).
- Sivetz, M., and N. W. Desrosier (1979). "Coffee Technology". AVI Publishing Co., Westport, CT, U.S.A.
- Thijssen, H. A. C., and W. H. Rulkens (1968). "Retention of Aromas in Drying Food Liquids". De Ingenieur (The Hague), 80, Ch45.
- Verhey, J. G. P. (1972-73). "Vacuole Formation in Spray Powder Particles". Neth. Milk Dairy Jour., 26, 186; 26, 203; 27, 3.
- Zakarian, J. A., and C. J. King (1980). "Volatiles Loss in the Nozzle Zone during Spray Drying of Emulsions". Submitted to Ind. Eng. Chem. Proc. Des. & Devel. [See also, J. A. Zakarian, Ph.D. dissertation in Chemical Engineering, University of California, Berkeley, CA, U.S.A., 1979].

FLAVOUR RETENTION DURING FREEZE-DRYING OF COFFEE

P. FOSBØL, M. Sc.,

E. E. PETERSEN, D. Sc.

A/S ATLAS, Copenhagen, Denmark

1. Introduction

Much attention has been paid to the behaviour of flavour retention during freeze-drying of liquid food and artificial model systems. Two basic mechanisms have been proposed for the retention of volatiles.

One, first put forward by Thijssen and associates (Thijssen & Rulkens 1968, Thijssen 1971, 1975) describes the retention by selective diffusion. They found that the diffusion coefficients for water and volatiles drop drastically as water content during drying decreases, but that the diffusion coefficients for volatiles drop to a considerably greater extent. In this way water can be removed by diffusion while the volatiles are kept back. During the freezing, ice crystals are formed and a matrix is made up of concentrated dry matter and volatiles, thereby increasing the selectivity. When the ice front retreats and water vapour diffuses out of the matrix structure during the sublimation, the dry matter content increases still further, and the diffusion of volatiles is effectively reduced. This model is later developed (Chandrasekaran & King 1972), and the diffusion process has been considered as a process in a ternary system of volatiles, water, and dissolved solids, but the basic mechanism of selective diffusion remains unchanged.

The second model, put forward by Flink, Karel, and associates (Flink 1970, 1975, Flink & Karel 1970 a, b, 1972 Chirife & Karel 1973, 1974, Kayert et al 1975) describes the retention of volatiles as an entrapment of volatiles in micro-regions. In these the volatiles are kept back, for example by hydrogen bonding between carbohydrate molecules and volatiles.

It has been noted (Chirife et al 1973) that the selective diffusion model and micro-region entrapment model may be macro and micro scale interpretations of the same phenomenon.

Using both models it is possible to explain that volatile retention during freeze-drying depends on

1. Initial content of dissolved solids
2. Freezing rate
3. Drying rate (= layer thickness)
4. Ice front temperature (= drying pressure)

in such a way that volatile retention increases if initial content of dissolved solids and drying rate are increased, and if the freezing rate and the ice front temperature are decreased, even when the ice front temperature is below the collapse temperature (Bellows & King 1973).

Most of the work carried out in relation to the above mentioned models are characterized by one or more of the following properties, which makes it questionable to transfer the result to industrial conditions for production of freeze-dried coffee:

1. Volatile retention has been measured using simple model systems composed of a carbohydrate and one or a few volatiles.
2. Volatile retention in real foods, including coffee, has been investigated (Petersen et al 1973, Masaldi & King 1974 a, b, Bartholomai 1975, Flink 1975, Gerschenson 1979) but the test conditions were often very far from those used in the industrial process.
3. Volatile retention has been measured using objective methods of analysis, for example gaschromatography.

It is well known that foods, and in particular coffee extract, contain a complicated mixture of dissolved solids and volatiles in a very great number. It is difficult to predict the effect of a change in the concentration of volatiles on the organoleptic quality of the food.

Industrial production of freeze-dried coffee takes place according to methods, which in principle differ from each other as regards to freezing method, ice front temperature (= drying pressure), and drying rate.

The purpose of the present work was to investigate experimentally the effect of the different production methods on the flavour retention. The effect was measured by means of a gaschromatographic and an organoleptic method of analysis respectively.

2. Materials and Methods

2.1 Coffee Extract

Coffee Extract industrially produced from a medium roasted Arabica blend has been used for all tests. Dissolved solids 33°Bx (= 27.4% dry matter).

2.2 Freezing of Coffee Extract

The extract has been frozen according to a one-stage and a two-stage freezing method respectively. The extract has been foamed by nitrogen to such a degree that the bulk density of the dried granulate in all cases was about 200 g/l.

2.2.1 One-Stage Freezing

Foamed extract of 10°C has been frozen in a layer thickness of 2-2.5 mm on a drum freezer of the type ATLAS Rota Freeze H 300. The freezing time was 2.8 minut, by which the extract was cooled to -38°C. On an average the freezing rate was about 1 mm/min.

2.2.2 Two-Stage Freezing

The extract has been foamed by nitrogen and prefrozen in a soft-ice machine of the type Carpigiani 211/P to a temperature in the interval of -5 → -4.5°C. The so treated coffee extract was stored for about 30 minutes at -5°C and thereafter distributed on a brine-cooled contact freezer (0.2 m²) in a layer of about 20 mm thickness. The contact freezer was placed in a cold room at a temperature of -40°C. The brine temperature has been regulated according to the program which is shown in Fig. 1. Final product temperature was -35°C. The average freezing rate was about 1 mm/min. as well.

In this way the difference between the two freezing methods has to be found in layer thickness and the rate, with which the freezing point was passed.

With the purpose to make the conclusion of the flavour retention results satisfactorily accurate, every freezing test has been repeated 3 times, in which way a total of 6 frozen samples were produced.

2.3 Grinding

The frozen flakes and blocks were granulated at an ATLAS granulator type 305, equipped with a 3 mm screen. The granulate was finally sieved on a 0.9 mm sieve.

2.4 Freeze-Drying

The frozen samples were freeze-dried in a pilot freeze-drier of the type ATLAS RAY 1.

Both types of granulate were freeze-dried at two different layer thicknesses, about 2 mm and 12-13 mm respectively, corresponding to drying times of 0.5 hr and about 6 hrs.

The drying pressure has been fixed in such a way that all dried samples had nearly the same dark brown colour. This means that the quick dried samples regardless of freezing method have been dried at 0.75 mbar water vapour pressure, while the pressure for samples dried in about 6 hrs correspondingly has been regulated at 0.35 mbar and 0.6 mbar for two-stage and one-stage freezing respectively. All drying tests were carried out at a maximum product temperature of 50-55°C. The results are summarized in table 1.

2.5 Storage

All 12 samples (4 methods, 3 repetitions) were packed in tins, which were stored at ambient temperature in the same container filled with Nitrogen. After a storage time of 6 months the flavour analyses have been carried out.

2.6 Volatile and Flavour Analyses

As mentioned, the volatile and flavour retention during freezing and freeze-drying have been measured using a gaschromatographic and an organoleptic method respectively. Extract stored at -60°C has been used as reference for both analyses.

2.6.1 Gaschromatographic Analysis

0.5 g dry matter of every sample including the reference was mixed with 20 ml boiling water in a 20 ml flask with membrane. After cooling to ambient temperature 5 μ l n-butanol was added as internal standard, and 5 μ l solution was injected in the gaschromatograph. Every analysis was made twofold.

A gaschromatograph of the type Hewlett-Packard model 5840 equipped with double flame ionization detector and electronic integrator has been used. The conditions of the gaschromatograph are listed in Fig. 2.

According to this method of analysis, chromatograms of the type shown in Fig. 2 have been obtained. A total of 38 peaks were found in all samples. Volatile content was calculated as content of n-butanol by use of the internal standard. Based on these data the retention was calculated for selected peak combinations, namely 1-10, 1-20, and 1-38.

2.6.2 Organoleptic Analysis

The taste and aroma of all samples in relation to the reference sample have been judged by a trained coffee panel using the following scale:

Score	Description
1	Excellent
2	Very good
3	Good
4	Satisfactory
5	Unsatisfactory

The score for the reference sample was defined as 3, corresponding to the description "good".

As serving plan was used a three times repeated symmetrical balanced, incomplete block design with 4 treatments, 4 blocks (= panellists) and 3 replications according to table 2. In this way every panellist has judged 3 samples in relation to the reference and allocated a score according to above listed scale.

2.7 Statistical Methods

The effect of the different processes has been treated according to well known statistical methods.

The results from the gaschromatographic analysis have been calculated as a simple analysis of variance, and confidence intervals were set up.

The statistical analysis of the organoleptic results has been made by using well established routines, and confidence intervals were set up (Cochran & Cox 1975, Gacula 1978).

3. Results and Discussion

The table of variance for the gaschromatographic analysis has been shown in table 3. The table includes the analysis of variance for volatile retention based on the total volatile content for the peak combinations 1-10, 1-20, and 1-38. In the cases, in which relatively few peaks have been considered, that means the peak combinations 1-10 and 1-20, we found very high significance ($p < 0.001$) against the hypothesis that there was no difference between the treatments. In case all 38 peaks have been considered, we found no significance. That means that the processes had no effect on the volatile retention if we judge the volatile content out from all 38 peaks.

The results have been marked out in Fig. 3, and 95% confidence intervals have been drawn. Considering the two cases in which the volatile retention has been calculated on the peak combination 1-10 and 1-20 we found nearly identical relations. The volatile retention was greater and about 100% using quick drying and two-stage freezing. At a corresponding slow drying we found a retention, which was clearly reduced to 85-90%. At one-stage freezing the drying rate had no clear influence on the retention. Regardless of the drying rate we found the flavour retention for one-stage freezing around 75%.

These results are qualitatively in accordance with the models which were described in the introduction. As mentioned there, the present work was carried out with the main purpose to compare the influence of different industrial freeze-drying processes on flavour retention rather than to test the effect of the single parameters. Therefore, up to two parameters had been altered at the same time and the effect of the single parameter could not entirely be separated. The investigation had shown, however, that the volatile retention for the most volatile components significantly increased if the freezing point was passed at lower rate, and/or if the ice front temperature was decreased. Increasing the drying rate had a positive effect on volatile retention at low freezing rate, but not necessarily at a high freezing rate.

Considering the volatile retention based on the total number of peaks, however, we found an average retention for all processes, which was 96.6%. In this case, in which all peaks were included, we found no influence of the freeze-drying processes.

The analysis of variance for the organoleptic analysis is shown in table 4. The table includes the analysis of variance for the panel scores of aroma and taste respectively. The effect of the different processes on both the aroma and the taste was far from significant, which means that we did not find any difference between the freeze-drying methods.

The results have been marked out in Fig. 4, and 95% confidence intervals have been drawn. The figure clearly shows that flavour score for all 4 methods was equal, and we could not distinguish the treatments from each other. We found an average aroma score of 3.5 ± 0.1 and an average taste score of 3.4 ± 0.1 , which should be compared with the score of the reference sample, which was defined as 3.0.

4. Conclusion

For the extract investigated we found that the organoleptic quality of freeze-dried coffee, which was produced according to normally used industrial processes, was independent of the process compared. It was possible to find objective differences in volatile retention considering a few volatiles, measured by means of a gaschromatographic method of analysis.

In accordance with several authors we found that the volatile retention for the most volatile components increased if the freezing rate and ice front temperature decreased, and if the drying rate increased.

This effect was obviously of minor importance and could not be demonstrated if numerous flavour components were considered. The effect on the organoleptic quality was marginal, not only because of the limited number of volatiles considered, but probably also because of the fact that rather big changes in stimuli are necessary to influence the sense impression.

5. References

- Bartholomai G.B., Brennen J.G. & Jowitt R. (1975) *Lebenson, Wiss u. Technol.*, 8, 25
- Bellows R.J. & King C.J. (1973) *AIChE Symp. Ser.* 69 (132), 33
- Chandrasekaran S.K. & King C.J. (1972), *AIChE J.* 18, 513 + 520
- Chirife J. & Karel M. (1973), *J. Agr. Fd. Chem.* 21, 936
- Chirife J. & Karel M. (1974), *J. Fd. Technol.* 9, 13
- Chirife J. & Karel M. & Flink J. (1973), *J. Fd. Sci.*, 38, 671
- Chochran W.G. & Cox G.M. (1957), *Experimental designs*, John Wiley & Sons, Inc., second ed. N.Y.
- Flink J. (1970), Ph. D. thesis, Massachusetts Inst. of Technol. Cambridge, MA 02139
- Flink J. (1975 a), In: *Freeze-Drying and Adv. Food Technol.* Academic Press, N.Y., ch. 23, pp 351
- Flink J. (1975 b), *J. Agr. Fd. Chem.*, 23, 1019
- Flink J. & Karel M. (1970 a), *J. Agr. Fd. Chem.*, 18, 295
- Flink J. & Karel M. (1970 b), *J. Fd. Sci.*, 35, 444
- Flink J. & Karel M. (1972), *J. Fd. Technol.*, 7, 199
- Gacula M.C. (1978), *J. Fd. Sci.*, 43, 1461
- Gerschenson L.N., Bartholomai G.B. & Chirife J. (1979) *J. Fd. Technol.* 14, 351
- Kayaert G., Tobback P., Macs E., Flink J. & Karel M. (1975), *J.Fd. Technol.* 10, 11
- Masaldi H.A. & King J.C. (1974 a), *J. Fd. Sci.*, 39, 438
- Masaldi H.A. & King J.C. (1974 b), *J. Fd. Sci.*, 39, 445
- Petersen E.E., Lorentzen J. & Flink J. (1973), *J. Fd. Sci.*, 38, 119
- Thijssen H.A.C. (1971), *J. Appl. Chem. and Biotechnol.*, 21, 372
- Thijssen H.A.C. (1975), In: *Freeze-Drying and Adv. Food Technol.* Academic Press, N.Y., ch. 23, pp 373
- Thijssen H.A.C. & Rulkens W.H. (1968), *De Ingenieur*, 80, (47) 45

Table 1: Drying Conditions for Freeze-Dried Coffee Samples

Sample Description	Sample No	Layer Thickness mm	Maximum Product Temperature °C	Drying Water Vapour Pressure mbar	Drying Time Hrs	Bulk Density g/l	(1) Residual Moisture %
One-stage Freezing	1					220	1.18
	2	ca. 2	50-55	0.75	0.5	240	2.10
	3					250	2.58
	4			0.58		250	1.12
	5	12-13	50-54	0.60	5-6	250	1.22
	6			0.60		270	1.55
Two-stage Freezing	7					180	1.80
	8	ca. 2	50-55	0.75	0.5	185	1.52
	9					190	1.74
	10			0.34		220	1.36
	11	12-13	50-53	0.34	6-7	205	1.22
	12			0.37		200	1.03

(1) : Karl Fischer titration

Table 2: Test Plan for Flavour Analysis

Treatment		Panellist No		1	2	3	4	5	6	7	8	9	10	11	12
		Quick Drying	Normal Drying	x	x	x	x	x	x	x	x	x	x	x	x
Two-stage Freezing	Quick Drying			x	x	x		x	x	x		x	x	x	
	Normal Drying			x		x	x	x		x	x				x
One-stage Freezing	Quick Drying			x	x		x	x	x		x		x		x
	Normal Drying						x		x	x	x		x	x	

x = served sample

Table 3: Analysis of Variance for Volatile Retention measured by a Gaschromatographic Method of Analysis

Source of Variance	d.f.	Peak No 1-10			Peak No 1-20			Peak No 1-38		
		s.s.	m.s.	F	s.s.	m.s.	F	s.s.	m.s.	F
Treatment	3	2160.6	720.2	10.5 ^{xxx}	4400.7	1466.9	22.2 ^{xxx}	341.7	113.9	2.6
Error of test	8	1013.1	126.6		1032.0	129.0		473.6	59.2	
Error of analysis	12	354.0	29.5		288.57	24.1		395.8	33.0	
Total error	20	1367.2	68.4		1320.6	66.0		869.4	43.5	
Total	23	3527.7			5721.3			1211.1		
95% confidence interval for mean values		± 7.1%			± 6.9%			± 5.6%		

Table 4: Analysis of Variance for Flavour Score

Source of Variance	d.f.	Aroma			Taste		
		s.s.	m.s.	F	s.s.	m.s.	F
Treatments (adjusted)	3	1.35	0.45	1.67	0.38	0.13	< 1
Repetitions	2	1.51	0.76		2.35	1.17	
Panellists within repetition	3	8.57			9.21		
Error	27	7.31			8.95		
Total	35	18.74			20.89		
95% confidence interval for mean values		± 0.38			± 0.42		

Fig. 1: Brine Temperature Program for Freezing of Coffee Extract
in Contact Freezer

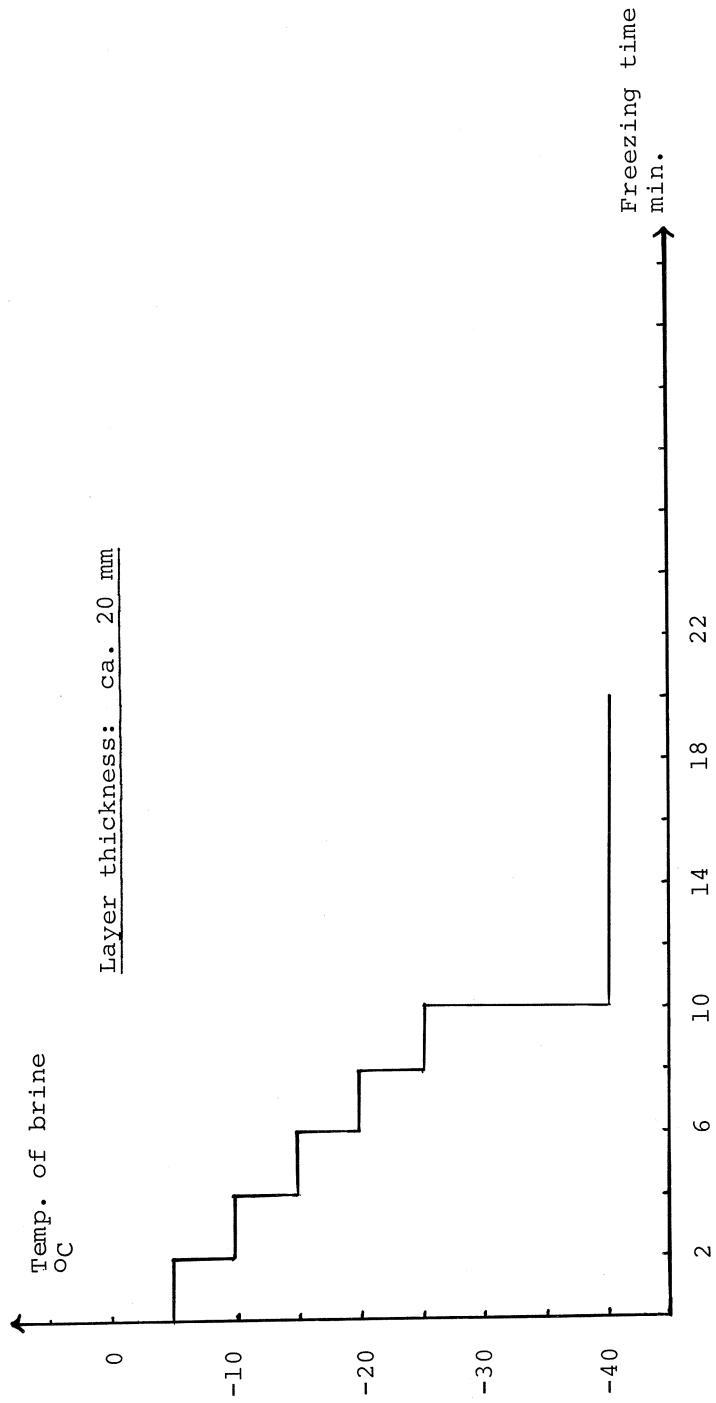
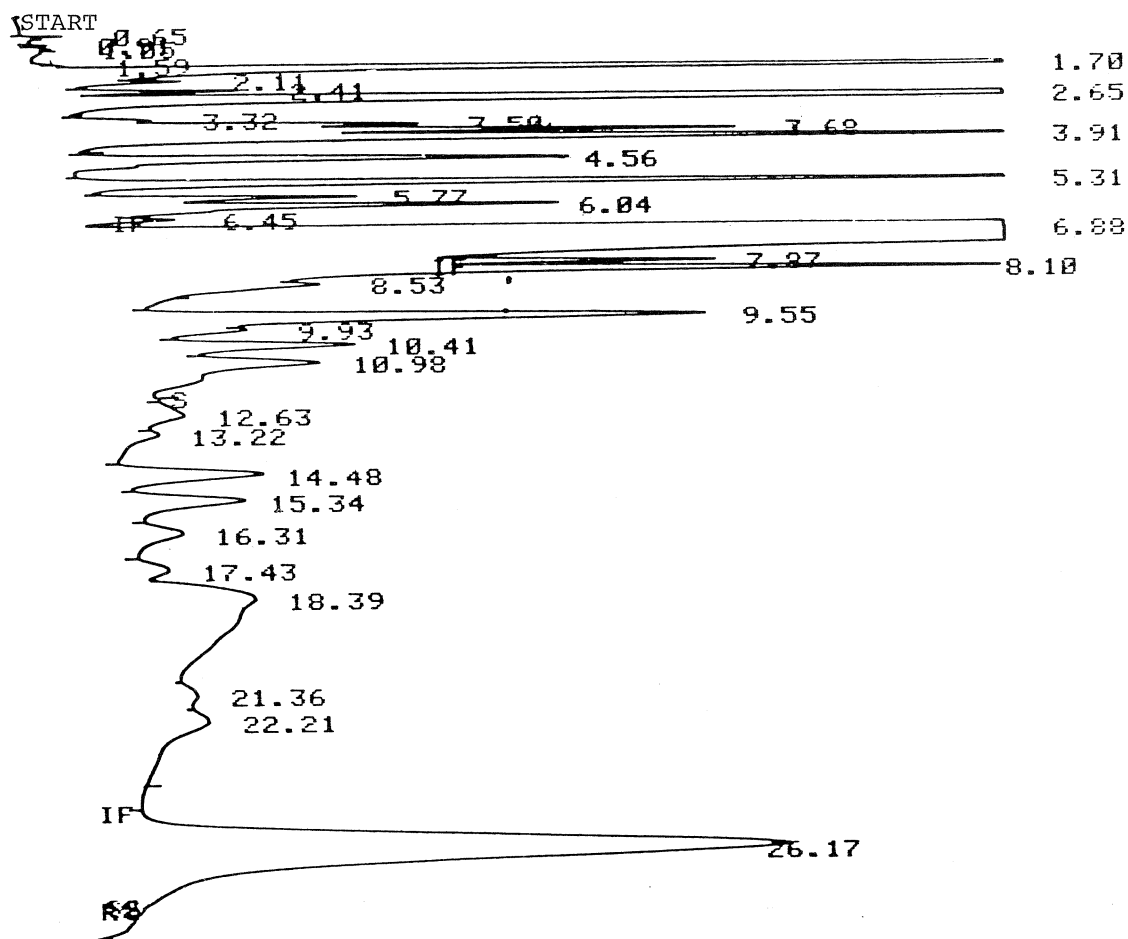

Fig. 2: Type of Gaschromatogram obtained on Freeze-Dried Coffee Samples



Chromatograph Conditions:

Column : Steel (1/8 in x 2 m) with 20% polyethylen glucol
20 M on Cromosorb W, Aw 80/100 Mesh

Injection : 250°C

Detector : 250°C

Column : Start 70°C in 0 min. Temp. program 10°C/min.
Final temp. 150°C

Gasflow : Test and reference column : 16.1 and 16.0 ml N₂/min.

Fig. 3: Relation between Volatile Retention and Freeze-Drying Process for Coffee Extract.
 Volatile Retention measured by a Gaschromatographic Method of Analysis for Different
 Number of Peaks

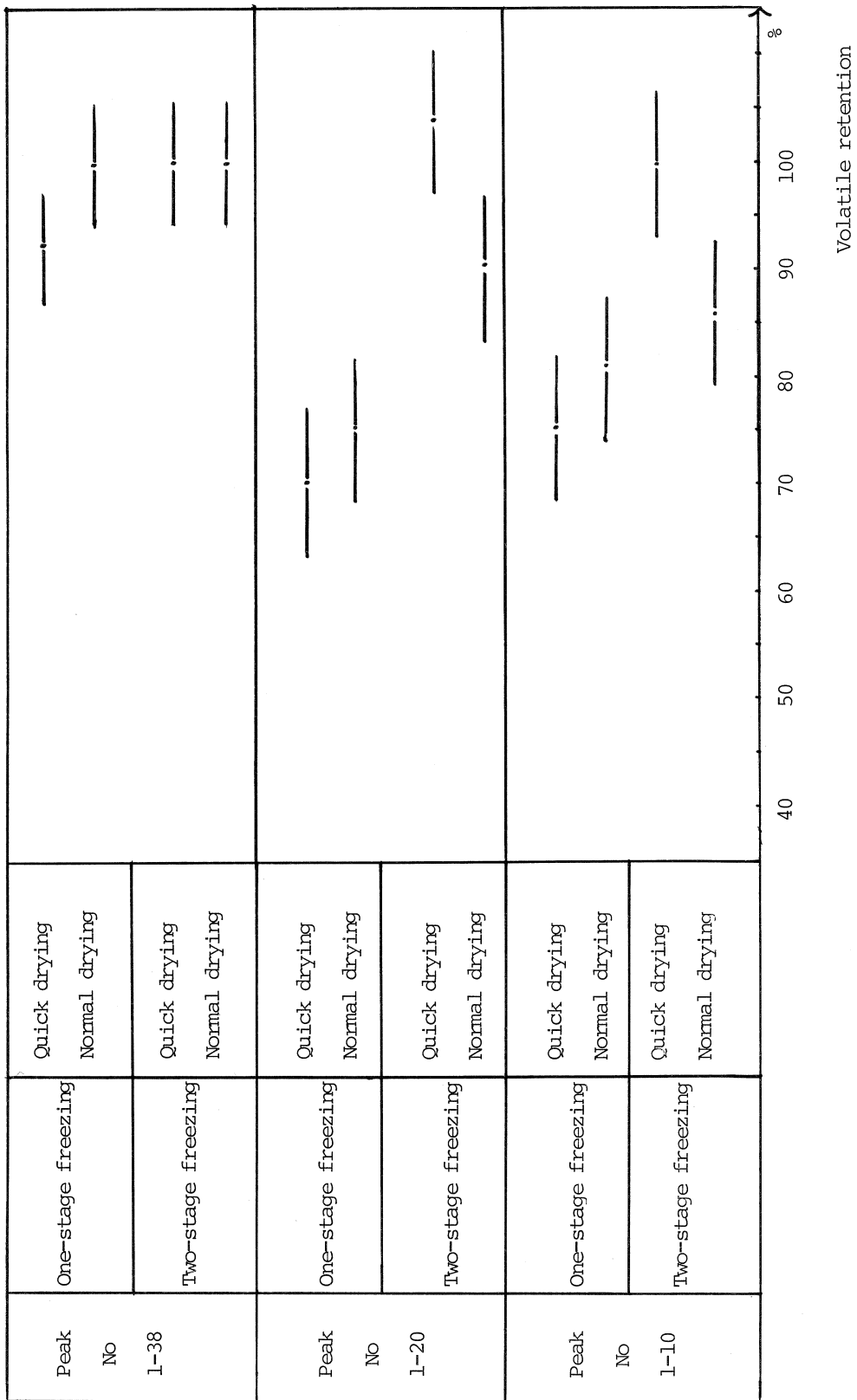
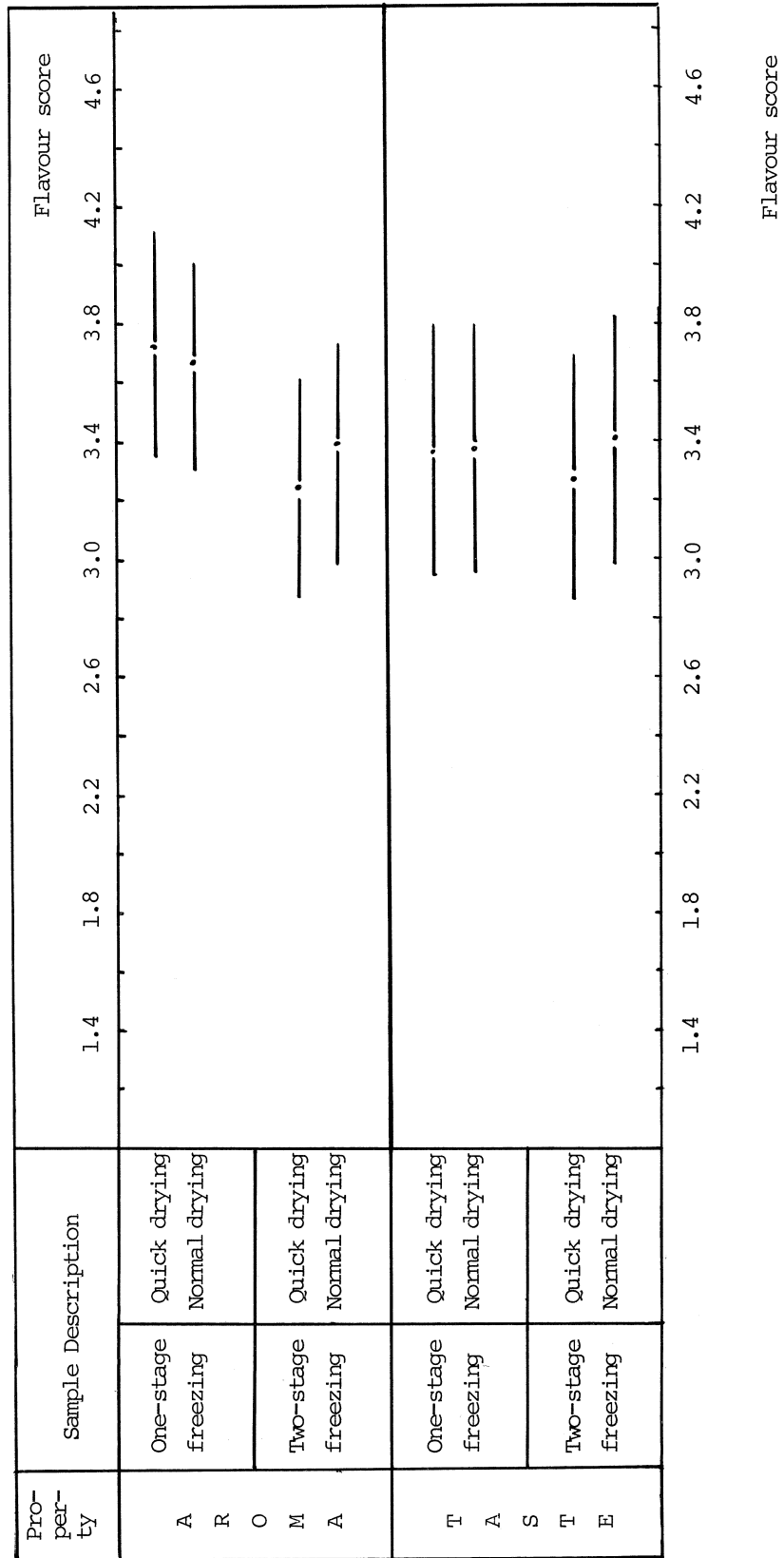

Fig. 4: Relation between Flavour Score and Freeze-Drying Process for Coffee Extract



POSSIBLE APPLICATIONS OF ENZYMES IN COFFEE PROCESSING



G. M. EHLERS

International Product Manager

Novo Industri A/S

Novo Allé

2880 Bagsvaerd, Denmark

The actual use of industrially produced enzymes in coffee processing is still rather limited; however, the wet processing method rely on enzymes formed during the fermentation process itself, so enzymes as such have been used just as long as wet processing has.

This paper deals with application of industrially produced enzymes in the form of highly purified, standardized enzyme preparations made by fermentation of a pure culture of a chosen bacterial or fungal strain.

Several articles and patents exist on application of enzymes of various types. Some of these are briefly mentioned and two described in a little more detail.

Review of Literature References.

It was reported already in 1963 by Sievertz and Foote (1) that addition of pectinases speeds up the removal of the mucilage layer during wet processing. This concept is used today on a commercial scale and is one of the two described in more detail later.

Most of the other enzyme applications are centered around instant coffee or coffee extracts, which of course is understandable as the degree of processing here is much higher.

A Japanese patent describes the treatment of coffee extract with proteinase, amylase and tannase, individually or in combination (2). This should reduce foaming when bottling soft drinks flavoured with coffee extract.

A German patent (3) is describing the use of a mixture of mannase, arabanase and xylanase for production of a storage stable, liquid coffee extract for coffee-dispensing automats. The storage stability is improved because of the removal of the pentosans.

A Japanese patent (4) describes the use of lactase (polyfenoloxidase), which is reported to promote the oxidation of caffeic acid hence increasing colour density.

S. Schwimmer and R.H. Kurtzman Jr. (5) and C.A. Woolfolk (6) have reported on decaffeination by means of microorganisms; however, they have generally been working with live microorganisms rather than purified enzymes, and although the effect seen is caused by enzyme action, it falls outside the scope of this paper.

A special enzyme application is described by J.R. Meyer (7). To prevent oxidation of packaged powders a semipermeable packet resembling a tea bag containing glucose, glucose oxidase and catalase is inserted before sealing the bag or can. This system is reported to keep the oxygen level as low, or lower than vacuum-packaging over nitrogen.

Application of Pectinases during Wet Processing.

Why Use Pectinases?

Mucilage removal after depulping remains one of the major problems in the wet processing of arabicas. Being a natural fermentation process, it is subject to many uncontrollable outside influences and gives therefore very variable results. Enzymatic depulping with pectinases permits more thorough and rapid work, by which temperature variations can be compensated for and a regular processing cycle established.

Coffee Processing is simplified, because the mucilage removal can be carried out according to a predetermined time schedule, independent of ambient temperature, degree of ripeness of the cherries, and all other factors influencing fermentation.

Plant capacity can be greatly increased by shortening mucilage-break-down to less than half the normal time, especially when this process is combined with underwater soaking at the same time.

The coffee quality is improved. Enzyme-treated coffee does not have the dull looking surface left by lengthy soaking and washing. The beans are clean, white and shiny, and they weigh more, and risk of "tainting" and of quality loss through microbial spoilage is greatly reduced.

The cost of treatment is negligible compared to the quality increase and the time saved. It is generally less than 0.5% of the coffee value.

No costly investments are necessary to obtain the full benefits of the application, the treatment can be done with the normal equipment in the existing installations.

The dosage of enzyme depends on the activity of the enzyme used. An average dosage rate for a pectinase like ULTRA-ZYM^R 100 is e.g. 20 grams per ton of clean coffee (or about 3 tons of wet parchment, or 5 tons of cherries) for a processing time of 12-16 hours in water of 14 to 16°C.

This dosage rate has to be adjusted to the pectin level of the cherries to be treated, the desired processing time and temperature. Half the dosage of the same enzyme is recommended for arabica and bourbon in hot weather conditions, while a 50% increase in dosage is needed in cold climatic zones or for caturra coffee. If the processing time has to be shortened to less than

that given above, the dosage must be increased additionally (if the contact time is divided by a certain factor, the enzyme dosage must be multiplied by the same factor to get the same result, e.g. to half the time corresponds double dosage).

The correct amount of enzyme is dissolved and diluted just before use. The solution is evenly distributed over the pulped coffee just covered with water in a water-tight tank and then well mixed to obtain uniform distribution of the enzyme.

If underwater fermentation is not possible, the enzyme-solution should be diluted even further. This diluted enzyme-solution is added to the coffee after depulping. The solution is stirred into the pulp and kept in a water-tight tank. The juice should not be allowed to drain off before the end of maceration time, to avoid losing part of the enzyme prematurely.

In some cases, a faster fermentation is possible by the higher temperature obtainable under the following conditions: The pulped coffee is thoroughly drained, then put into a water-tight fermentation tank and the enzyme solution evenly sprayed over it with a sprayer.

Particular care should be taken in washing-off the enzyme and mucilage as soon as pectin-degradation is completed. This prevents the surface of the beans to become white and dull-looking. The sooner and the better the coffee is washed, the shinier it remains.

In other words by using pectinases for mucilage degradation, processing times can be controlled more accurately. This is possible by the simple method of selecting the correct enzyme dosage to suit the factory routine. In addition, coffee yield and quality are improved, as is the coffee taste in the cup.

Application of Galactomannanase.

The application of pectinases is well established today. A much newer enzyme, galactomannanase is just about to find its position in the coffee industry.

This enzyme breaks down galactomannans, thus reducing the viscosity of coffee extracts. With the increasing energy costs this feature becomes more interesting as the lower viscosity allows the coffee extract to be evaporated to a higher solids content by traditional evaporation before going to the spray- or freeze-dryer.

The temperature characteristics of a commercially available galactomannanase produced by *Aspergillus niger* is shown in Fig. 1. The optimum temperature is around 80°C. However, the increase in activity with temperature is rather small, which means that lower temperatures may be chosen for the reaction.

The optimum pH lies around pH 5.0, which is in the same range as that commonly found in coffee extracts.

Experiments were carried out in our laboratories on redissolved instant coffee. Fig. 2 shows the viscosity development in a 65% coffee solution without enzyme and with 0.1% Gamanase added. The enzyme dosage is calculated w/w on dissolved solids. As can be seen from the figure, the viscosity is reduced to almost half when using enzymes.

Fig. 1.

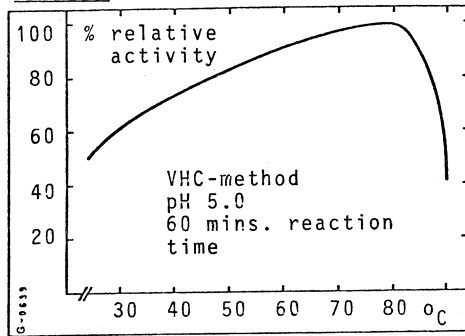

Effect of temperature on the activity of GamanaseTM

Fig. 2.

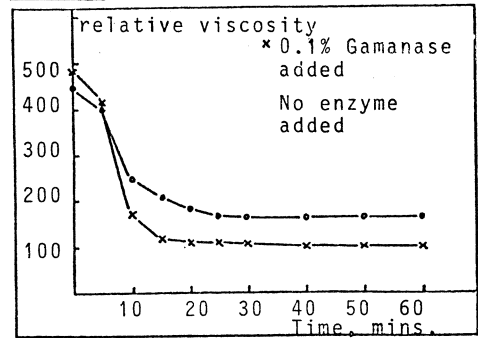

Reduction of the viscosity of instant coffee with Gamanase 65% w/w dry substance, 70°C pH ~ 5.

To illustrate the rationale behind the application fig. 3 represents some typical mass balances from an instant coffee plant with extraction figures, starting from 100 kg beans, which after roasting have been reduced to 84 kg. A split extraction leads to two extracts, the aroma product (I), which contains the majority of the aroma components and the hydrolysis product (II), which contains the majority of dissolved solids. The extracts then go to evaporation and/or drying. The 14 kg dissolved solids in extract I goes to the freeze- or spraydryer without concentrating further, whereas extract II is concentrated in a traditional evaporator (often a falling film evaporator), from approx. 12% solids to approx. 40% solids, (i.e. the evaporator removes 163 kg H₂O per 28 kg of dissolved solids). The two extracts are then remixed before drying.

Fig. 3.

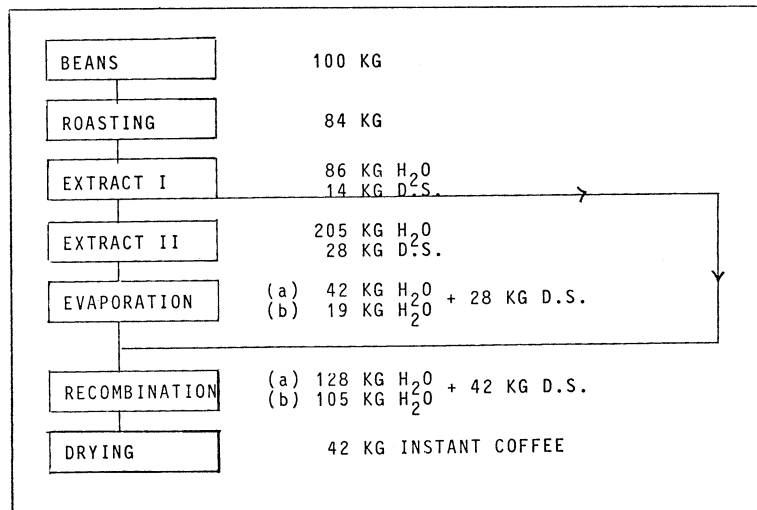

Starting from 100 kg coffee beans a commonly used procedure will in other words end up with a solution of 42 kg solids in 128 kg H₂O (a).

When treating extract II with galactomannanase the viscosity of the extract is reduced and it is possible to remove some more water in the evaporator; on the figure is shown a solids content of approx. 60% (19 kg H₂O, 28 kg dissolved solids (b)), meaning that an extra 23 kg of water per 42 kg of finished product has been removed by the cheaper traditional evaporation process rather than the more costly freeze- or spraydrying. By doing this the daily energy costs are reduced. As freeze-drying is more expensive than spraydrying the potential savings are of course also larger. Apart from daily running costs the capacity of the drying equipment is influenced. As can be seen from the figure the dryers only have to remove 105 kg H₂O/42 kg solids(b) instead of 128 kg (a), giving around 20% increase in capacity. This is especially of importance when installing new equipment as existing plants may not have the flexibility to utilize this extra capacity.

The absolute value of the process for the individual instant coffee producer can only be determined by making trials on the spot. Exact energy prices, mass balances, coffee quality etc. are variables that are basically only known by the manufacturer. The treatment as such, however, is generally easy to fit into the existing process. The enzyme, which is in liquid form, is added to extract II before sending it to the evaporators. A holding time of 15 mins. at 70°C is enough to obtain the required effect, but a longer reaction time at a lower temperature will also work.

The application of enzymes in coffee processing is still very limited; however, with rising energy prices, applications like the one just described will become increasingly more interesting. Who knows, the whole extraction procedure which today is based on a high temperature process, may eventually be replaced by an enzymatic extraction.

Literature References.

1. Enzymes in Food Processing
G. Reed and L. Underkofler, Academic Press
1966 p. 374.
2. Jap. patent Ja 4.848.668 (Derwent 59 098 U).
3. German patent 2.063.849 (Derwent 44 457 T).
4. Jap. patent J7 5037-742 (Derwent 02880x).
5. Journal of Food Science Vol. 37, 921 (1972).
6. Journal of Bacteriology 1975, 1088-1106.
7. Dairy Sci. 1960, 43, 844 (from Process Bio-chemistry May 1979).

CONSUMER AND EXPERT EVALUATIONS OF STORED COFFEE PRODUCTS



W. P. CLINTON

Maxwell House Division

General Foods Corporation

250 North street

White Plains, New York 10625

This presentation summarizes the pertinent data obtained in evaluating the quality changes of roasted and ground vacuum packed coffee and agglomerated and freeze dried coffees as sold at retail in the United States.

Quality assessments were made by an expert panel for flavor and aroma as a function of storage time. Acceptance by consumers was also determined by usage in the home over a period of time.

In both the expert and consumer tests, products were coded and randomized in their presentation in order to minimize bias.

Specific variables of moisture, oxygen and temperature exposure were emphasized in this study and the results positioned against a time frame consistent with age of product in distribution in the Market Place in the United States.

(SLIDE 1)

The first slide is a graph which presents the expert panel flavor evaluation of roasted and ground coffee packed under different vacuums and stored at 70°F over a period of 2 years.

The quality rating on the left is a 10 point scale with the quality increasing as the number increases. Note the moisture content of all samples to be 4.3%.

Zero time and all of the graphs you will see today represent the quality within a 24 hour period after packing.

As expected the quality decreases more rapidly the lower the vacuum (or the higher the oxygen). At 29" vacuum there are about 3.2 c.c. oxygen with one pound of coffee. This compares with 97.2 c.c. oxygen if coffee were left in contact with air. Oxygen levels in contact with coffee at the other vacuums can be calculated in a similar manner.

Of interest is the rapid drop in quality rating in the early storage period. This is very characteristic of most storage changes including soluble coffees to be shown later. The period probably reflects the initial rapid reaction between oxygen and coffee. The more oxygen present the longer this decline takes place before levelling off.

An evaluation of the aroma in the package by the expert panel was also carried out but in the interest of time I am not showing the graph for this. Suffice to say that the package aroma ratings follow the same pattern as the flavor rating.

Of particular importance is the 4 to 12 week time period. The 4 week period is the earliest a consumer can buy a product and 12 weeks represents the average age of product at point of sale. The importance of this will be covered in a few minutes.

(SLIDE 2)

The next slide shows the effect on flavor quality resulting from different moisture levels in roasted and ground coffee - keeping the vacuum constant at 29 inches. As expected increasing moisture tends to increase the rate of quality change.

At this point it is of interest to show what the reaction of consumers is to the different levels of quality as defined by the experts. For this purpose four levels of quality were chosen for testing in the home among people who normally buy and use vacuum packed canned coffee.

(SLIDE 3)

The people were asked to use these coffees for 2 weeks and rate the coffee on a preference scale as shown in the next slide. The coffee samples were coded and randomized in their presentation to avoid bias. Each person had only one sample to evaluate.

The four quality levels picked for the tests were 3.5, 5.3, 6.8 and 7.5. The 7.5 quality is one which a consumer would not be able to buy because it has not reached the point of sale yet. The 3.5 quality could represent a poor vacuum pack or a defective can which allowed air to enter after packing (called a leaker).

The next slide shows the results of the consumer tests for the four levels of quality.

(SLIDE 4)

The difference in consumer quality rating between the 6.8 and the 7.5 is not significant. All other comparisons are statistically significant at the 95% confidence level.

If the data for quality change with time such as was shown on Slide 1 is used to predict quality within the time span of product availability to consumers, it is possible to develop a prediction of consumer preference for the product within the life span for the product at point of sale.

(SLIDE 5)

The next slide shows this prediction using the earliest a consumer can buy after production, namely 4 weeks. The starting point in developing this graph is to plot the consumer preference rating and the related expert quality rating. The expert quality rating and the consumer preference rating form the two axes.

The next step is to obtain the expert quality rating at 4 weeks. The rating for the 28" vaccum sample is used for this illustration since this is well within the capability of U.S. manufacturer. This quality rating is 6.8 and it intersects the curve at a 3.74 consumer preference rating. It is now determined how low the consumer preference rating has to be to become statistically significant at the 95% confidence level. This rating is 3.59 and it intersects the curve at an expert quality rating of 5.6. From this plotting of the data, a prediction can be made that as long as the quality rating by expert panel is 5.6 to 6.8, there should be no significant difference in preference among consumers. Other starting points besides the ones shown on this plot can be used and a prediction made as to consumer preference.

The same approach was applied to storage of agglomerated and freeze dried coffees. A series of slides now follow which show the expert quality ratings and consumer preference ratings related to storage time.

I'll go through these without too much detailed comments since the approach is basically the same as shown for the roasted and ground coffee.

(SLIDE 6)

This graph shows the change in expert flavor quality rating for both agglomerated and freeze dried coffees over a period of a year and a half at 70°F. The moisture and oxygen conditions of the packed products are shown.

Note that the quality rating for the freeze dried begins to change more rapidly than agglomerated after the 6 month period.

(SLIDE 7)

This graph shows the change in expert quality rating for freeze dried coffees of different moistures. Within the range of moistures shown there is very little quality change during the first year.

(SLIDE 8)

This graph shows the expert quality ratings for agglomerated soluble coffees of different moisture levels. There is a consistent half point difference in quality rating between the 3.9 and 5.1% moistures starting at the 9th month.

(SLIDE 9)

Two quality levels were chosen for agglomerated and freeze dried coffees to be tested among consumers who normally buy agglomerated and consumers who normally buy freeze dried coffees. The next slide shows the consumer preference rating (using the same scale shown earlier) and the corresponding expert quality rating. The lower quality level samples represent a quality end point for an air packed product after 6 to 12 months.

The most significant point is the relatively small and statistically non-significant difference in consumer preference for products which are rated very different in quality by the expert.

Applying the same procedure for prediction of consumer acceptance as was done for roasted and ground coffee the following graph was developed for freeze dried coffee.

(SLIDE 10)

The earliest a consumer can buy freeze dried coffee is 4 weeks after production and the expert quality rating at that point is 6.8. This intercepts the time at a point which gives a consumer preference rating of 4.18. A preference rating of 3.96 or lower is needed to generate a statistically significant difference and this corresponds to an expert quality rating of 3.2.

(SLIDE 11)

The next slide shows the predicted values for agglomerated instant coffee which has an earliest date for purchase of 4 weeks after production. According to this prediction the expert quality rating can change from 6.6 to 2.5 without resulting in a significant change in consumer preference rating.

(1)

EFFECT OF VACUUM (OXYGEN) ON QUALITY
ROASTED & GROUND COFFEE 4.3% H₂O
EXPERT PANEL FLAVOR

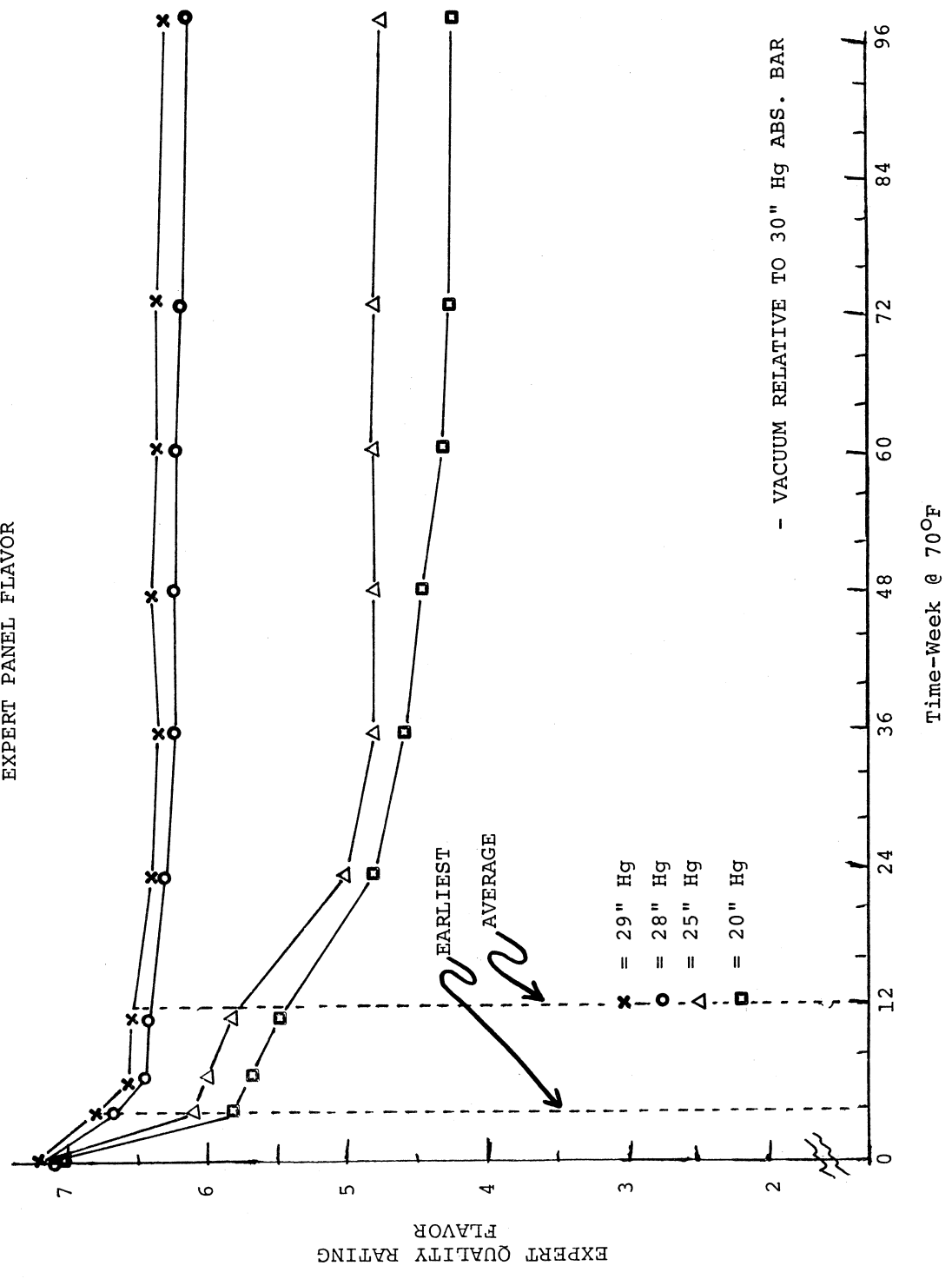

EFFECT OF WATER CONTENT ON QUALITY
 ROASTED & GROUND COFFEE - 29" Hg VACUUM
 EXPERT PANEL - FLAVOR

(2)

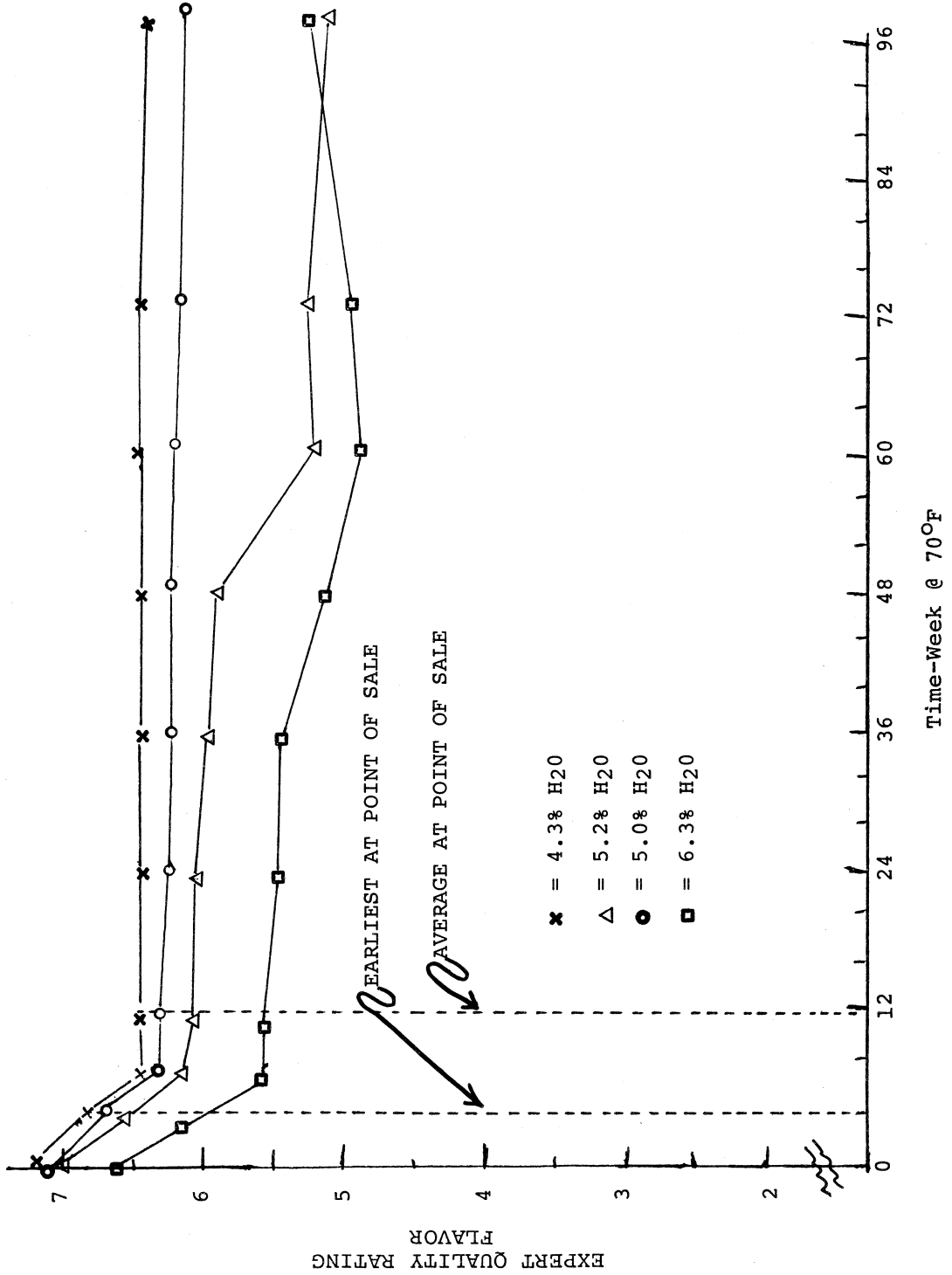

(3)

PREFERENCE SCALE USED
BY CONSUMERS

<u>DESCRIPTION</u>	<u>NUMERICAL SCALE ASSIGNED AFTER TEST</u>
EXCELLENT	6
EXTREMELY GOOD	5
VERY GOOD	4
GOOD	3
FAIR	2
POOR	1

(4)

CONSUMER PREFERENCE
ROASTED & GROUND COFFEE

<u>EXPERT QUALITY RATING</u>	<u>CONSUMER PREFERENCE RATING</u>
7.5	3.74 ⁽¹⁾
6.8	3.79 ⁽¹⁾
5.3	3.55 ⁽²⁾
3.5	3.11 ⁽³⁾

(1) VS. (2) VS. (3) STATISTICALLY
SIGNIFICANT AT 95%.

ROASTED AND GROUND COFFEE
EARLIEST (4 WEEKS)

(5)

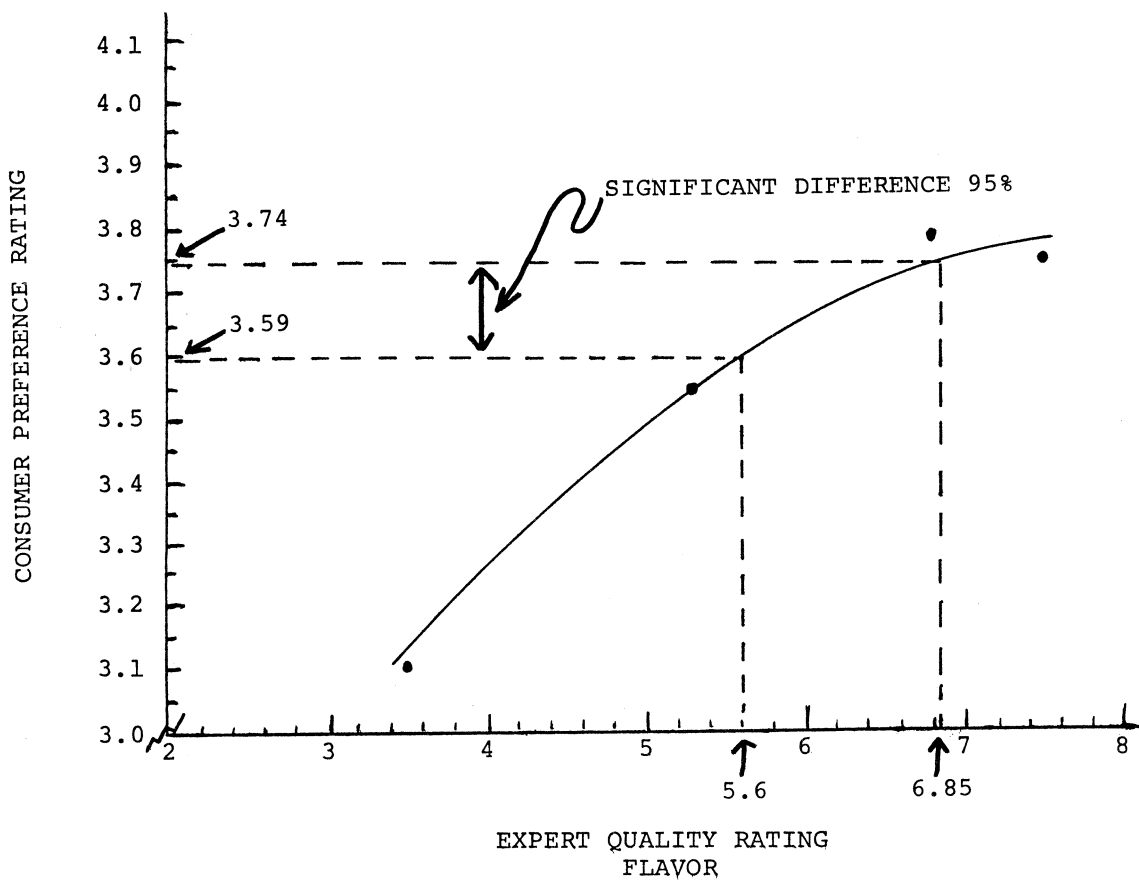

(6)

QUALITY OF AGGLOMERATED
AND FREEZE DRIED COFFEES
EXPERT PANEL - FLAVOR

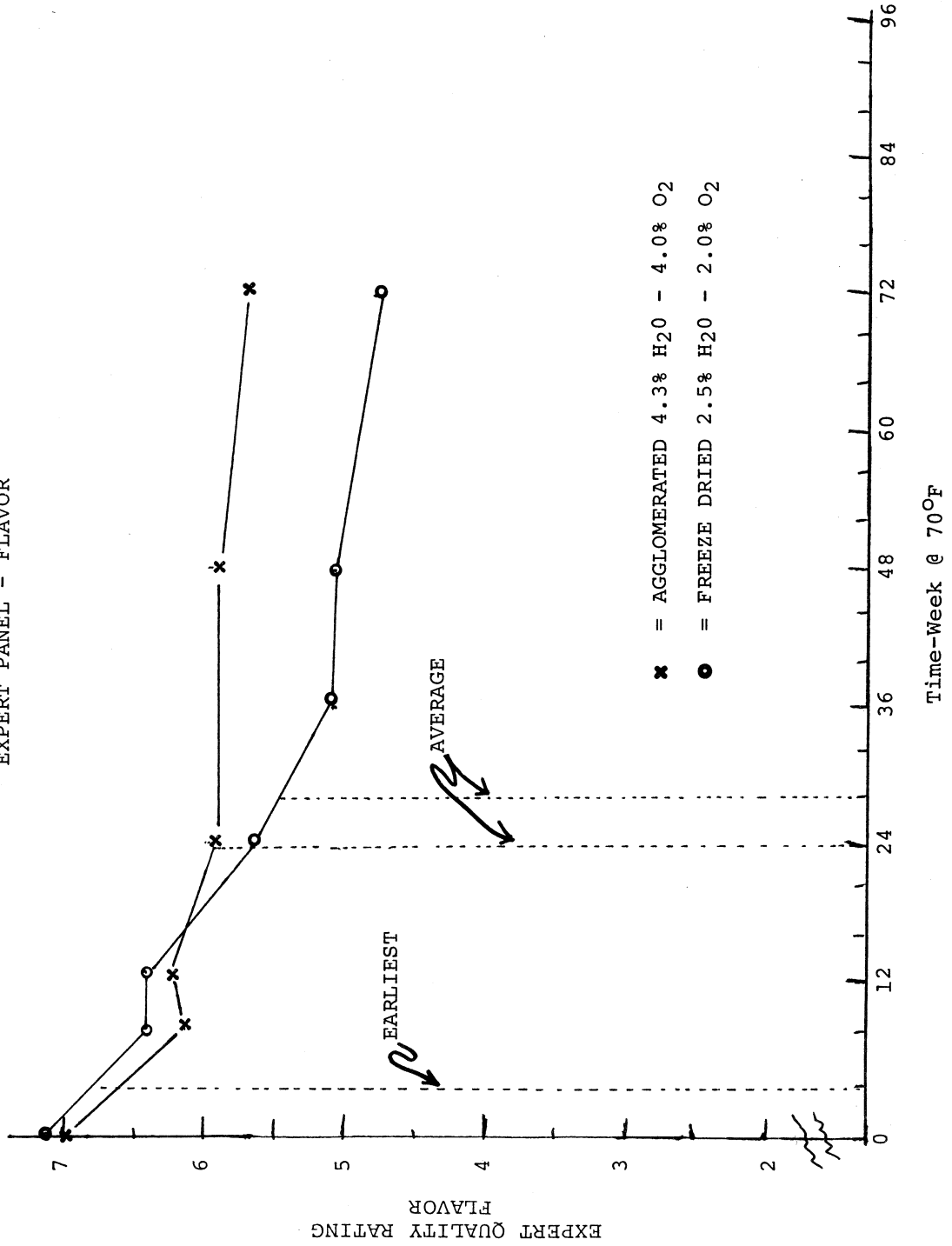

QUALITY OF DIFFERENT WATER CONTENTS
FREEZE DRIED COFFEE
EXPERT PANEL - FLAVOR

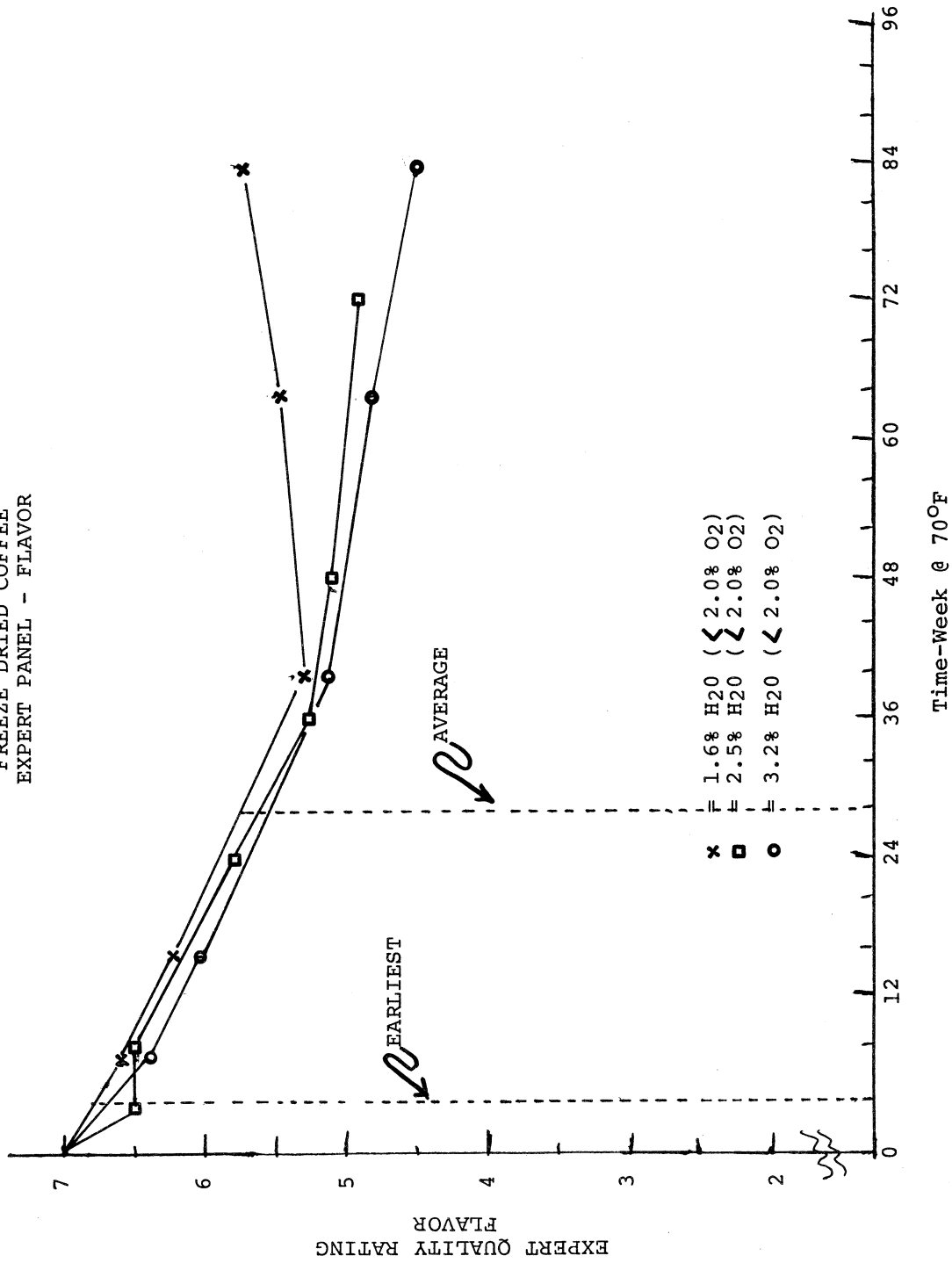

EXPERT QUALITY RATING

EARLIEST

AVERAGE

x = 1.6% H₂O (Σ 2.0% O₂)
□ = 2.5% H₂O (Σ 2.0% O₂)
○ = 3.2% H₂O (Σ 2.0% O₂)

Time-Week @ 70°F

(8)

AGGLOMERATED COFFEE QUALITY
DIFFERENT WATER CONTENTS
EXPERT PANEL - FLAVOR

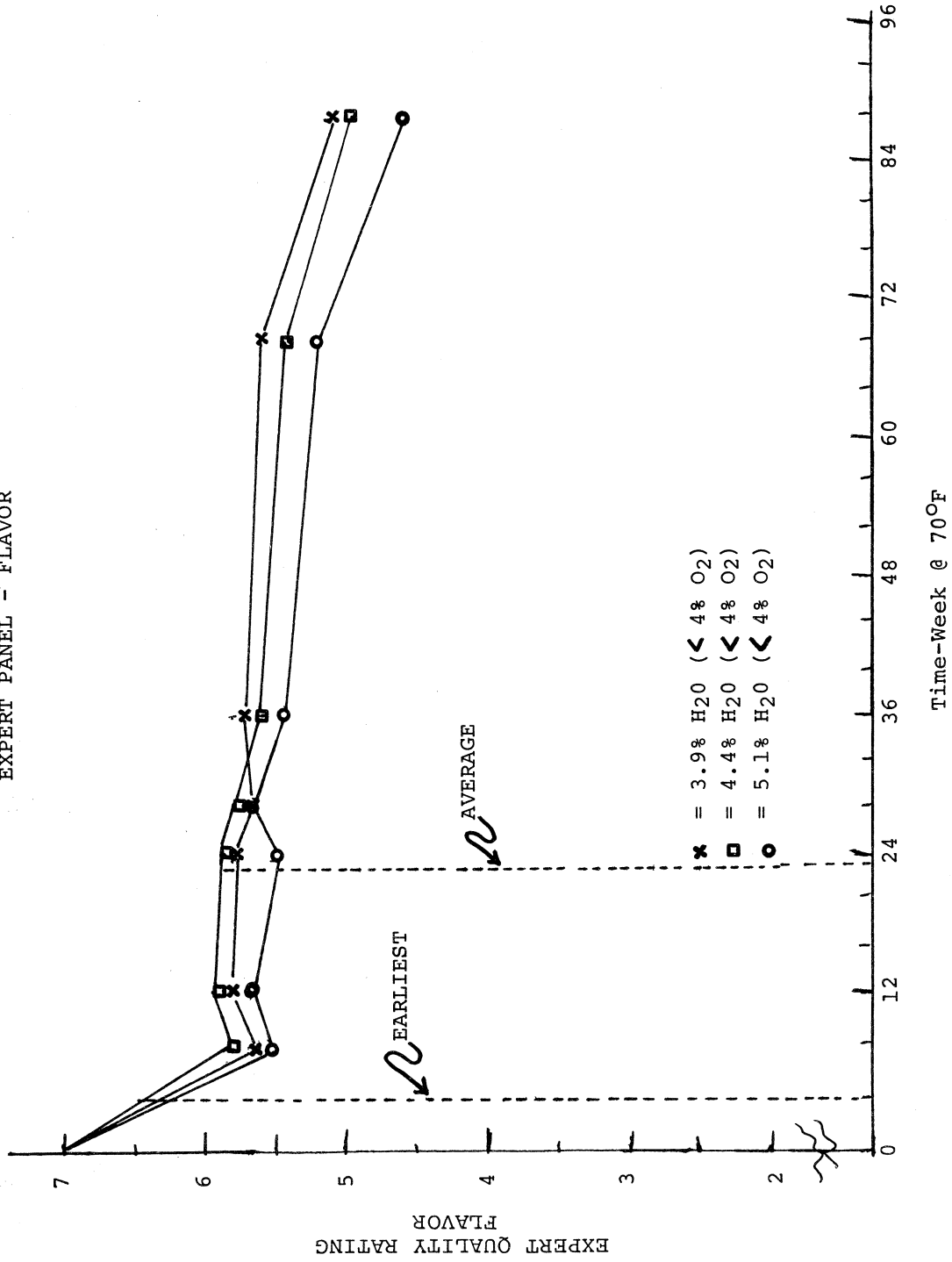

CONSUMERS PREFERENCE

(9)

<u>AGGLOMERATED</u>		<u>FREEZE DRIED</u>	
<u>EXPERT QUALITY RATING</u>	<u>CONSUMER PREFERENCE</u>	<u>EXPERT QUALITY RATING</u>	<u>CONSUMER PREFERENCE</u>
6.3	3.84 (1)	6.4	4.17 (2)
4.2	3.71 (1)	3.6	3.99 (2)

(1) NOT SIGNIFICANT

(2) NOT SIGNIFICANT

FREEZE DRIED COFFEE
EARLIEST (4 WEEKS)

(10)

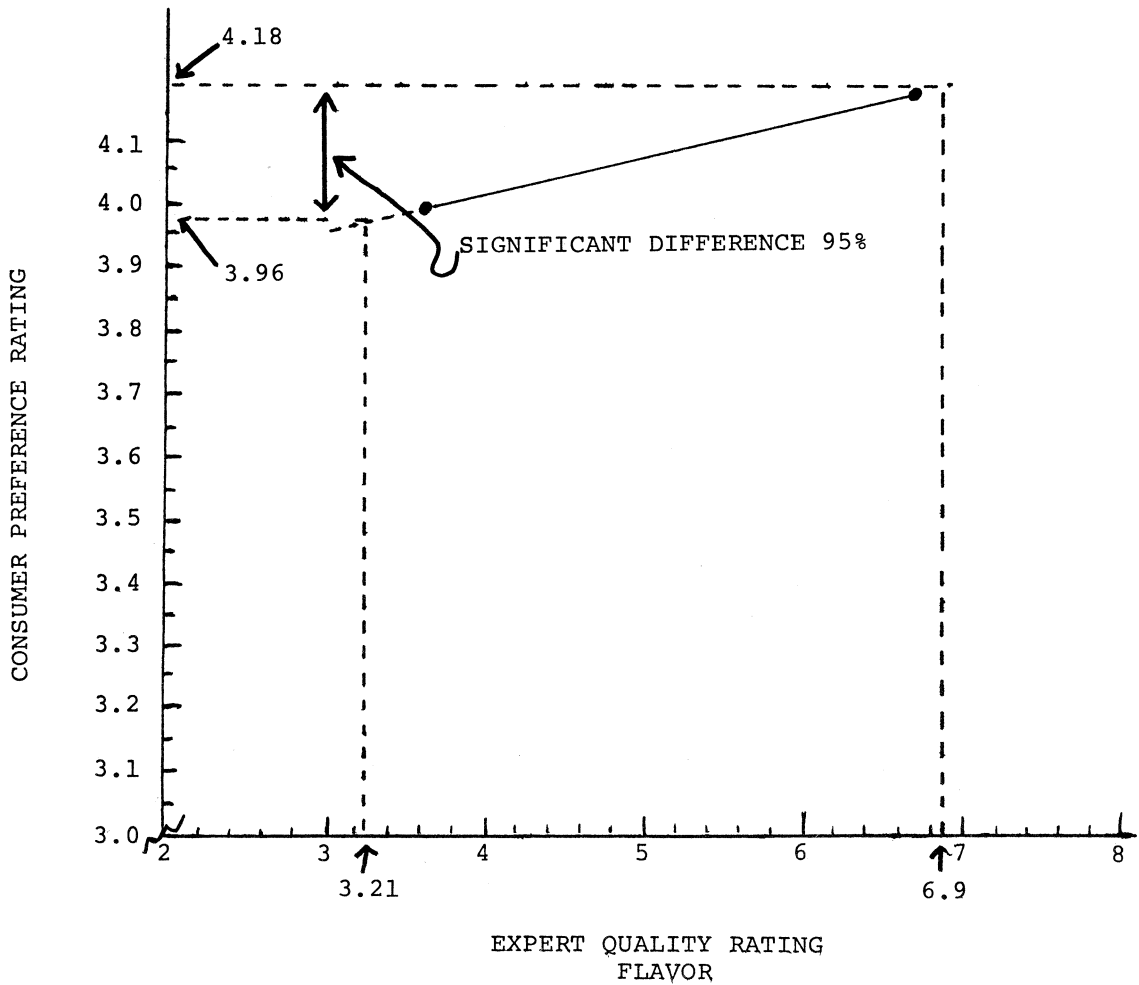

AGGLOMERATED COFFEE
EARLIEST (4 WEEKS)

(11)

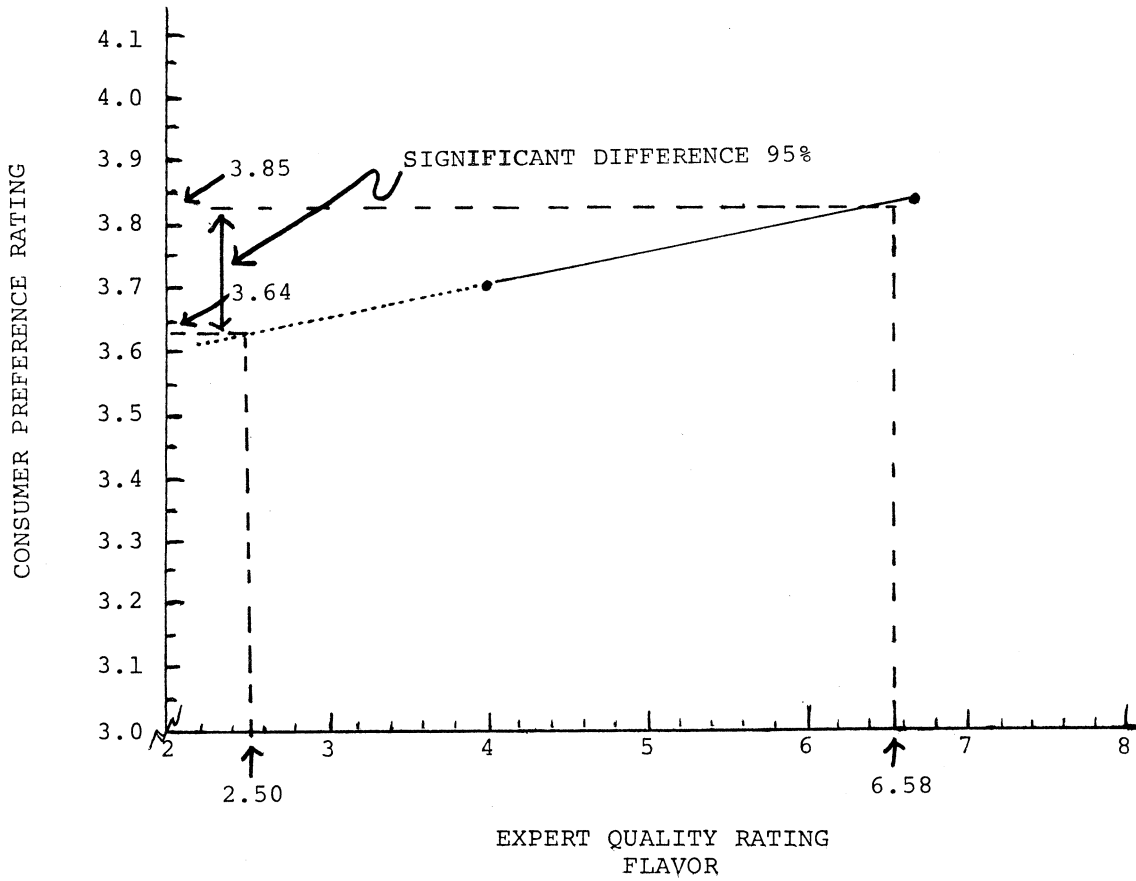

ÉVALUATION DES QUALITÉS D'UNE TASSE DE CAFÉ : EFFET DE LA TEMPÉRATURE DE L'EAU D'EXTRACTION

A. VOILLEY, F. SAUVAGEOT, P. PIERRET

Laboratoire de Biologie Physico-Chimique

ENS.BANA, Campus Universitaire de Montmuzard, F-21100 Dijon

INTRODUCTION

Les caractères organoleptiques du café-boisson dépendent de l'origine du café, des conditions de traitement du café vert, de la torréfaction (CROS et al., 1979) et du stockage ; mais ils dépendent aussi très étroitement des conditions mises en oeuvre pour l'extraction. Des études mettant en évidence l'influence des conditions de préparation entrant dans l'extraction ménagère du café-boisson ont été réalisées par MERITT (1958), SIVETZ et al. (1963), NATARAJAN (1965), PANGBORN et al. (1971), PICTET et al. (1977), VOILLEY et al. (1977-1978). Parmi les paramètres d'extraction, la température de l'eau semble jouer un rôle important sur les propriétés organoleptiques d'une tasse de café. C'est pourquoi, nous avons entrepris une étude systématique de ce facteur.

EXPÉRIMENTATIONS

I - Préparation du café-boisson

Une machine expérimentale du type expresso a été utilisée (figure 1). Son principe de fonctionnement est le suivant : De l'eau chauffée par 2 résistances (2) est admise de la chaudière de 10 litres (1) dans l'enceinte de dosage (3) dont le volume est fixé à l'avance. Cette eau est mise en contact avec la mouture en mettant en communication l'enceinte de dosage et le bac à mouture (6) par déplacement d'un clapet (5). Le passage de l'eau au travers de la mouture se fait sous une pression constante appliquée par l'intermédiaire d'un piston (4) et le café est recueilli dans un réceptacle (7). Toutes les opérations se font automatiquement grâce à un circuit pneumatique commandé par un circuit électrique. L'ensemble du système est sous pression, ce qui permet des extractions à des températures supérieures à 100°C sans provoquer l'ébullition du café-boisson.

La température est mesurée dans le lit de mouture et on la fait varier de 70 à 120°C (\pm 1°C) de 10 en 10°C. Toutes les autres conditions sont fixées :

. pression : Elle est supérieure de 1,2 bars à la pression régnant dans l'ensemble du système.

- . temps de contact mouture-eau avant la filtration : 7 sec.
- . proportion mouture - eau : 10/100
- . granulométrie de la mouture : entre 0,6 et 0,8 mm.

Le café, torréfié dans des conditions standard et stocké à - 45°C, est une variété Coffea Arabica. L'eau est une eau minérale de composition connue.

Après extraction, nous obtenons un café-boisson qui sera caractérisé par des évaluations sensorielles et par des analyses physico-chimiques.

Figure 1 : Partie mécanique de l'extraction expérimentale.

- 1 - CHAUDIERE
- 2 - RESISTANCE CHAUFFANTE
- 3 - ENCEINTE DE DOSAGE
- 4 - PISTON
- 5 - CLAPET
- 6 - BAC A MOUTURE
- 7 - RECEPTACLE
- 8 - LIMITEUR DE COURSE DU PISTON

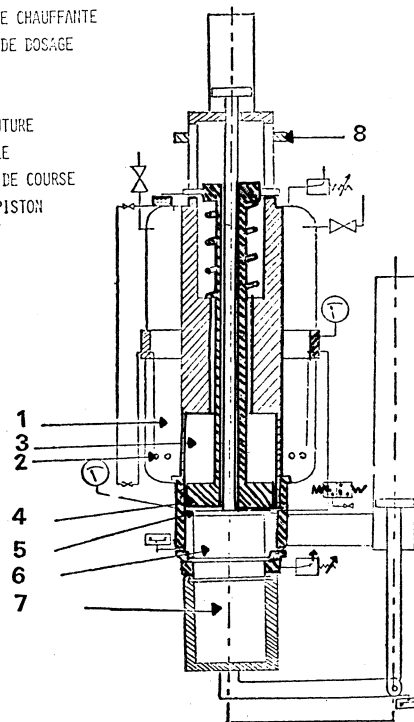

II - Analyses physico-chimiques du café-boisson

Les sédiments (de l'ordre de 100 mg dans 100 ml de café-boisson), parties insolubles, renseignent sur la qualité de la filtration.

L'extrait sec (ES) correspond à la teneur en matières solubles extraites ; il est lié à la consistance du café-boisson et est exprimé en grammes pour 100 ml de boisson.

Le taux d'extraction (TE) représente le rendement de l'extraction c'est-à-dire la quantité initiale de mouture.

Le pH et l'acidité sont mesurées et cette dernière est exprimée en milliéquivalents d'acide sulfurique pour 100 ml de café boisson.

La densité optique à 430 et 510 nm renseigne sur la quantité de pigments extraits responsables de la couleur.

La conductance (m Mho) peut être déterminée rapidement et permet de suivre l'évolution de la concentration en électrolytes.

La teneur en caféine est mesurée par une méthode chromatographique, la chromatographie liquide haute performance.

Toutes ces mesures sont effectuées après un temps déterminé car nous avons montré que la conservation exerce une influence sur ces propriétés.

III - Evaluation sensorielle du café-boisson

Pour l'évaluation sensorielle du café-boisson, un jury de 5 personnes a été sélectionné sur ses aptitudes à déguster du café à l'aide de 2 types d'épreuves :

- épreuves de classement portant sur du café soluble à 5 g/l d'extrait sec additionné de quantités variables d'acide tartrique, de caféine et d'arôme café naturel. 4 échantillons sont évalués pour chaque épreuve.

- épreuves 5/2 portant sur des cafés solubles à différentes teneurs en extrait sec. Cette technique consiste en une épreuve d'arrangement de 5 verres en 2 groupes : un groupe "café dilué" à 25 ou 20 % en extrait sec par rapport au café de référence. Les évaluations sont faites à 20°C et en lumière rouge.

Les performances des juges sont les suivantes : Ils sont sensibles à la différence dans un café à 5 g/l d'extrait sec entre une addition de caféine de 0,6 et 1,4 g/l. Ils sont sensibles à une addition d'acide tartrique de 0,32, 0,70 et 1,16 g/l mais ils ne sont pas sensibles à une addition de 5 à 23,7 ml/l d'arôme café naturel. Par contre, ils sont sensibles à une variation de ± 3 g/l d'extrait sec dans un café boisson à 15 g/l.

Après la sélection, le jury a été caractérisé et les cafés extraits à différentes températures ont été évalués avec le même type d'épreuve, des comparaisons par paire. Pour cette épreuve (figure 2) un essai est comparé à un témoin et on demande quel est l'échantillon le plus ... pour différentes caractéristiques.

Figure 2 : Comparaison par paire.

Nom : _____ Prénom : _____ Stalle : _____
 Vous commencez par l'échantillon : _____
 Des deux échantillons : _____ et _____
 Quel est l'échantillon

. le plus caractéristique en parfum	<input type="checkbox"/>	Tfa	Fa	De	Di	Qi
. le plus intense en parfum	<input type="checkbox"/>	Tfa	Fa	De	Di	Qi
. le plus amer	<input type="checkbox"/>	Tfa	Fa	De	Di	Qi
. le plus acide	<input type="checkbox"/>	Tfa	Fa	De	Di	Qi
. le plus caractéristique en arôme	<input type="checkbox"/>	Tfa	Fa	De	Di	Qi
. le plus intense en arôme	<input type="checkbox"/>	Tfa	Fa	De	Di	Qi

Remarques
 - l'un de ces cafés (ou les deux) présente-t-il :
 un goût de brûlé ? oui - non Si oui : n° de l'échantillon :
 un goût de cuit ? oui - non Si oui : n° de l'échantillon :
 un goût de caramel ? oui - non Si oui : n° de l'échantillon :
 - Observez-vous des différences de consistance ?
 oui - non Si oui : quel est l'échantillon le plus consistant ? :
 Autre(s) remarque(s) : _____

Différences perçues comme :
 Très faciles : Tfa
 Faciles : Fa
 Délicates : De
 Difficiles : Di
 Quasi impossibles : Qi

Puis ces cafés préparés à différentes températures ont été dégustés par 100 personnes. L'épreuve est un test de préférence (figure 3).

3 cafés numérotés ... vous sont présentés. Il vous est demandé de les sucrer en mettant le même nombre de morceaux de sucre dans chacun des 3 verres, de les classer dans l'ordre de vos préférences et enfin de donner les raisons de votre choix.

Vous suivez l'ordre : D'abord ... puis ... enfin ...

Café que j'aime le moins → Café que j'aime le plus +

n° du café	3	2	1
Pourquoi			

Figure 3 : Test de Préférence

Epreuve de classement

Buvez-vous habituellement du café "expresso"?

oui --- non ---

Quel type de café utilisez-vous habituellement ?

café en grain (moulu ou non) ---
café soluble (en poudre) ---

Quand buvez-vous habituellement du café ?

Petit déjeuner ---
Après le repas de midi ---
A un autre moment --- Lequel ---

Combien mettez-vous de morceaux de sucre ---

Age : --- Sexe : F-- M--

La caractérisation du jury a porté sur des cafés solubles dégustés chauds (55°C) dont l'extrait sec variait de 10, 15 et 20 % par rapport à un témoin à 15 g/l (tableau 1).

Tableau 1 : Caractérisation des juges.

Paires Variations E.S.		Qualité en parfum	Intensité en parfum	Qualité en arôme	Intensité en arôme	Amertume	Acidité
T	E	T	T	T	T	T	T
10 % 15 g/l 13,5g/l		14	16	16	19	19	15
15 % 15 g/l 12,75g/l		14	20	14	21 ⁺	18	19
20 % 15 g/l 12 g/l		18	20	21 ⁺	22 ⁺	22 ⁺	18

T = Témoin Seuils à 5 % : 21⁺, à 1 % : 23⁺⁺, 1% : 25⁺⁺⁺
E = Essai

Les résultats sont exprimés en nombre de réponses (30) donnant le témoin plus ... que l'essai pour chaque qualité. Nous remarquons que les juges perçoivent une différence significative de l'arôme et de l'amertume pour une variation de 20 % en extrait sec par rapport au témoin.

RÉSULTATS ET DISCUSSION

Avant l'évaluation sensorielle des échantillons préparés à différentes températures, nous avons vérifié la reproductibilité du témoin (extrait à 95°C) a priori, par évaluation sensorielle à l'aide de tests triangulaires et a posteriori, en vérifiant qu'il n'y avait pas de variations significatives entre tous les témoins par une analyse de la variance sur les valeurs de l'extrait sec. Les échantillons sont évalués 30 minutes au plus après leur préparation à 55°C et en lumière rouge.

La figure 4 présente l'évolution des propriétés sensorielles en fonction de la température de l'eau d'extraction (exprimées en nombre de réponses donnant l'essai plus... que le témoin).

Si l'on recherche des relations linéaires entre les propriétés sensorielles et la température de l'eau d'extraction, analysées au moyen du coefficient de corrélation linéaire, on constate que certaines propriétés telles que la couleur, l'intensité de l'amertume, de l'arôme et de l'acidité augmentent significativement quand la température augmente. D'autres propriétés apparaissent relativement indépendantes de la température d'extraction telles que la qualité et l'intensité du parfum, la qualité de l'arôme. Nous avons recherché s'il existe des corrélations linéaires à l'intérieur de ce groupe de propriétés ; par exemple, la couleur, très bien corrélée avec la température de l'eau d'extraction, l'est également avec les 3 autres propriétés qui augmentent significativement avec la température. Par contre, il n'y a pas de corrélation significative entre acidité et amertume. Ceci est provoqué par les valeurs trouvées pour la température de l'eau d'extraction à 100°C. Pour cette température, en effet, il y a opposition entre acidité sensorielle et amertume sensorielle.

Les propriétés physico-chimiques évoluent globalement dans le même sens que les propriétés sensorielles. Elles augmentent avec la température sauf le pH qui diminue. (figure 5)

Le tableau 2 montre l'évolution des propriétés physico-chimiques par rapport à la valeur trouvée à 70°C. Cette évolution n'est pas égale pour chacune des propriétés. Un indice global de la teneur en matières solubles tel que l'extrait sec ne permet pas de rendre compte de la qualité du café. Par exemple, la variation totale d'extrait sec entre 70 et 120°C est de 43 % par rapport à 70°C. Si on considère que la variation est relativement linéaire, on peut admettre une variation de l'extrait sec de 3,5 % pour une augmentation de la température de l'eau d'extraction de 10°C. Or, nous avons observé que cette différence est perçue par les juges. Cette variation ne pourrait être perçue par les juges s'il n'y a qu'une simple dilution comme nous l'avons montré au cours de la caractérisation du jury. Il y a donc un effet qualitatif de la température de l'eau d'extraction sur les propriétés organoleptiques du café-boisson obtenu.

Tableau 2 : Evolution des propriétés physico-chimiques en fonction de la température.

	Propriétés physico-chimiques							
	Extrait sec g/100ml	Taux d'extraction (%)	pH	Acidité (meq H ₂ SO ₄ /100ml)	Densité optique 430nm	Densité optique 510 nm	Conductance (m.Mho)	Caféine g/l
Variation de 70°C à 120°C	0,473	4,03	- 0,22	0,218	0,398	0,195	0,51	0,395
Variation en % de la valeur à 70°C	43	42	- 5,4	55	110	135	29	29,4

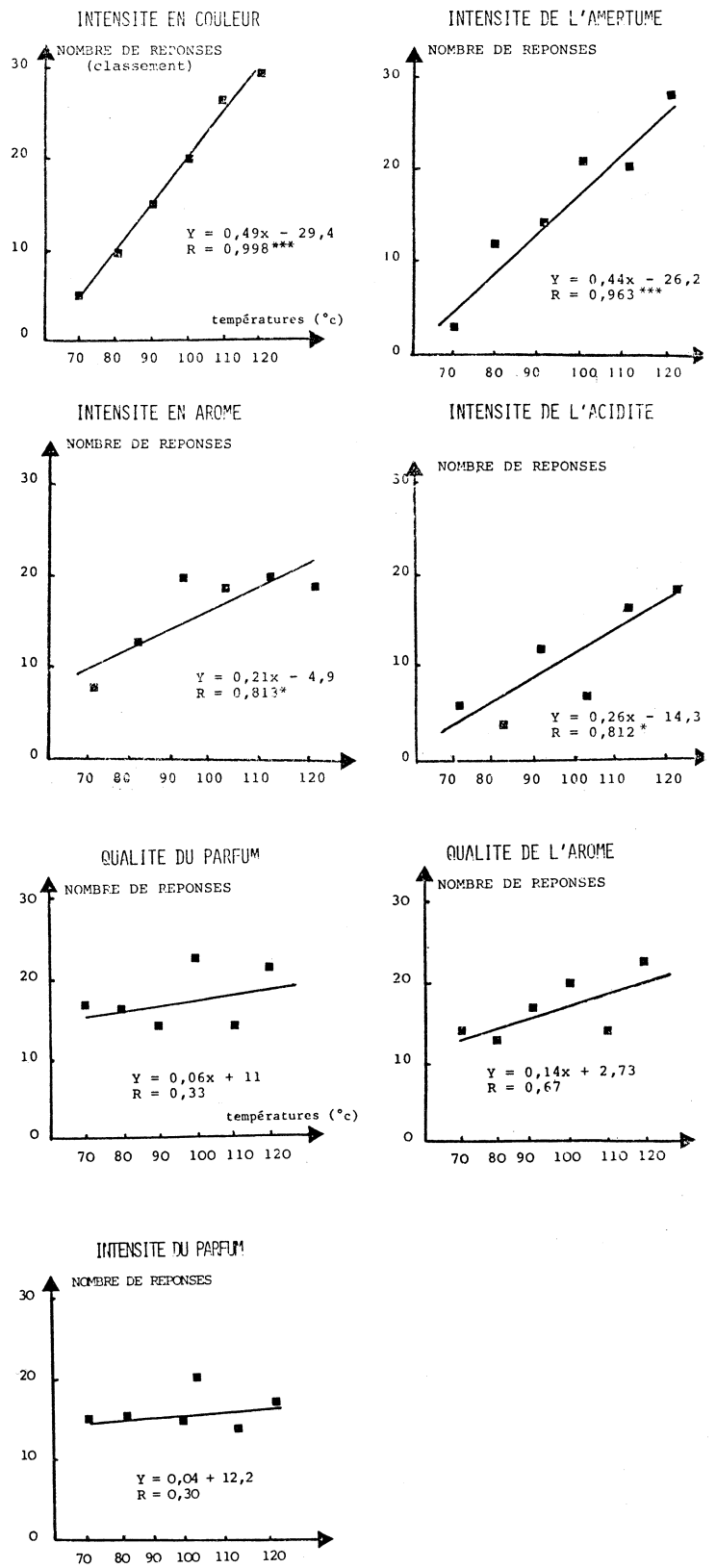

Figure 4 : Evolution des propriétés sensorielles en fonction de la température.

Seuil à 5 % $R = 0,75^{**}$
 1 % $R = 0,87^{***}$
 1 % $R = 0,95^{****}$

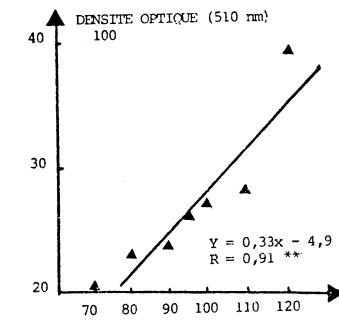
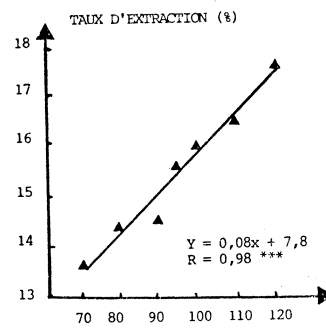
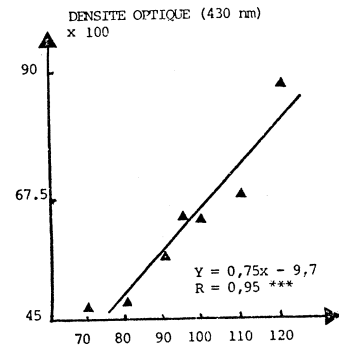
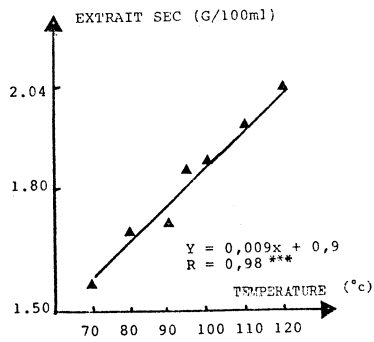
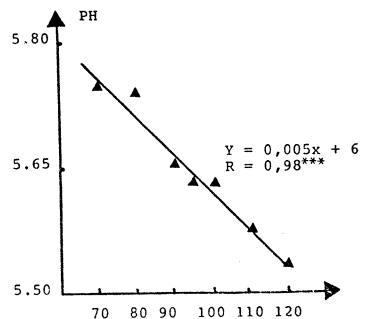
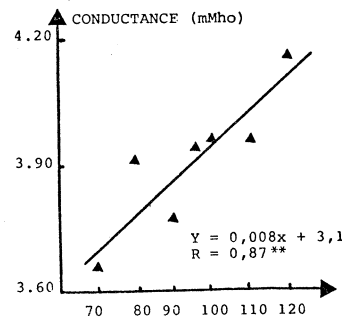
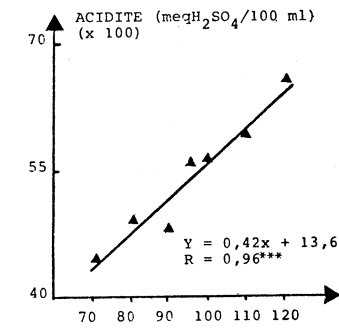
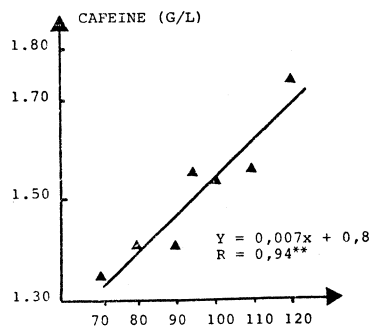

Figure 5 : Evolution des propriétés physico-chimiques en fonction de la température.

Seuil à 5 % R = 0,75 *
à 1 % R = 0,87 ***
à 1 % R = 0,95 ***



Le tableau 3 montre globalement qu'aucun café n'est préféré à un autre bien que leurs caractéristiques physico-chimiques soient significativement différentes.

Tableau 3 : Etude de préférence pour des cafés préparés à 3 températures.

Température de l'eau d'extraction	90°C	100°C	110°C
Evaluation sensorielle			
Préférence (somme des rangs)	204	206	<u>190</u> (100 personnes)
- selon le sexe	[93	95	<u>82</u> (45 hommes)
- selon les habitudes de consommation exemple : la nature du café	[111	111	<u>108</u> (55 femmes)
- par ceux qui consomment du café expresso ou en grains	75	<u>63</u>	66 (34 personnes)
- par ceux qui n'en consomment pas	129	143	<u>124</u> (66 personnes)
- par ceux qui consomment du café soluble	53	48	<u>38</u> (23 personnes)
- par ceux qui n'en consomment pas	<u>152</u>	158	<u>152</u> (77 personnes)

En effet, on constate que si on effectue la somme des rangs de préférence, la différence entre ces 3 cafés n'est pas significative (test du χ^2). De plus, il n'y a pas d'influence de l'ordre de présentation, des classes d'âge (entre 18 et 80 ans), du sexe et des habitudes de consommation. Les consommateurs préfèrent un café à un autre s'ils le jugent plus aromatique et moins amer d'après les résultats de l'épreuve.

CONCLUSION

Pour trouver des différences entre échantillons, d'un point de vue sensoriel, on ne doit pas poser une question de type hédonique et il est nécessaire de faire appel à un jury entraîné en vue, par exemple, d'évaluer les qualités d'une tasse de café en complément d'analyses physico-chimiques simples.

BIBLIOGRAPHIE

- CROS E., GUYOT B., VINCENT J.C. Profil chromatographique de la fraction volatile du café. Différence entre cafés verts sain et puant. Influence de la torréfaction sur le grain et la boisson. Café - Cacao - Thé, 23, 3, 1979, 193-201.
- MERITT M.C., PROCTOR B.E. Extraction rates selected components in coffee brew. Fd Res. 1959, 735-742.
- NATARAJAN C.P., SHIVASHANKAR S., BALACHANDRAN A., BHATTA D.S. Performances of a commercial expresso machine. Indian coffee. 24, 5, 1965, 5-7.
- PANGBORN R.M., TRABUE I.M., LITTLE A.C. Analysis of coffee, tea and artificially flavored drink prepared from mineralized waters. J. Fd Sc. 36, 1971, 355-362.
- PICTET G., VUATAZ L. Etude des techniques d'infusion. 8ème Colloque International sur la chimie des cafés. Abidjan, C.I., 1977,
- SIVETZ M., FOOTE H.E. Coffee processing technology. Av. Publishing Company Easton U.S.A., 2, 1963, 127-161.
- VOILLEY A., SAUVAGEOT F., DURAND D. Influence sur l'amertume d'un café-boisson de quelques paramètres d'extraction. 8ème Colloque International sur la Chimie des Cafés. Abidjan C.I., 1977,
- VOILLEY A., SAUVAGEOT F., SIMATOS D., WOJCIK G. Influence of some processing conditions on the quality of coffee brew. V International Congress of Food Science and Technology. Kyoto (Japan) Sept. 1978.

DECAFFEINATION OF COFFEE



S. N. KATZ
Maxwell House Division
of General Foods Corp.
Hoboken, New Jersey 07030
U.S.A.

INTRODUCTION

Caffeine is the most commercially important member of a group of alkaloids of which purine is the basic structure. Others in the group are xanthine, theophylline and theobromine.

Caffeine occurs free and bound in a number of plants especially coffee, tea, cacao, and kola nuts and these are by far the major source of caffeine consumption.

Its major pharmacological property is as a stimulant for the central nervous system. Measureable minor effects include:

1. Diuretic
2. Striated muscle stimulant
3. Several cardiovascular effects

Because of its ability to increase mental activity and wakefulness refined caffeine is used to help prolong wakefulness. Its major use, however, is in popular cola beverages where it supplies a mild pickup. In the pharmaceutical industry, caffeine is many times used by itself and with a mixture of other active ingredients.

Since its isolation from coffee in 1820 by Runge, the physical and chemical properties have been greatly studied. Much of this information is available in the standard chemical, biochemical and pharmacological literature.

MANUFACTURE OF CAFFEINE

Production of caffeine falls into three categories:

1. Extraction from plant materials, e.g., coffee or tea.
2. Extraction of theobromine from cacao and methylation.
3. Total synthesis, e.g., from uric acid or urea and chloroacetic acid.

At the present time the two main sources of caffeine are: From coffee as a byproduct of the manufacture of decaffeinated coffee and the total synthesis from urea and chloroacetic acid. The current use of caffeine in the United States is about 7 MM lb/yr (3 MM kilo/yr), half of which is natural and half synthetic.

CAFFEINE FROM COFFEE

The physiological effect of coffee is due to its caffeine content. Average caffeine content of the two major sources of coffee Arabica and Robusta is 1 and 2% respectively. A cup of regular coffee will contain on the average 85 mg of caffeine with a reported range of 65 to 125 mg. A cup of instant coffee will contain on the average 60 mg of caffeine with a reported range of 40 to 110 mg. Desire to develop a coffee flavored beverage without the physiological effects mentioned earlier prompted the invention of a process for removing caffeine from coffee with an organic solvent by Roselius and Wimmer in Germany in the early 1900's. Following the foundation of Kaffee HAG in Bremen in 1906 Roselius built a coffee decaffeination plant in New Brunswick, New Jersey, U.S.A. During World War I the business was expropriated by the American government and came into the possession of the Kellogg Co. A new decaffeination plant was built in Battle Creek, Michigan.

In 1927 Roselius returned to the United States and entered into a partnership arrangement with the General Foods Corp. to produce decaffeinated coffee under the Sanka label in New York. Roselius in 1932 sold his interest in the Sanka business to General Foods and in 1937 General Foods bought the American Kaffee HAG Co. from Kellogg to become the sole producer of caffeine-free coffee in the United States and Canada. It was not until the mid 1950's that Nescafe and C & S introduced their decaffeinated coffees into the U.S. market to compete against Sanka. Green decaffeinated coffee can be purchased in Europe from Coffex S.A. of Schaffhausen, Switzerland; Kaffee-Veredelungs-Werk, Hamburg, Germany and Coffein Compagnie, Bremen, Germany.

Commercial decaffeination of coffee is almost always performed in green coffee beans prior to the roasting process where flavors and aromas are developed. However, patent literature cites decaffeination from roasted beans as well as roasted coffee extract. The two major commercial decaffeination techniques are either based on solvent decaffeination or water decaffeination.

SOLVENT DECAFFEINATION

As shown in Table 1, there are numerous solvents listed in patents that can be used for decaffeination. The choice depends on the cost of solvent, the ease of removal and recovery, the specificity for caffeine and of most importance safety, especially in the present consumer environment. Benzene was originally used, but as chlorinated hydrocarbons became available at reasonable prices it was dropped in favor of trichloroethylene and methylene chloride. Trichloroethylene has been under investigation by the United States Food and Drug Assoc. since 1976 and methylene chloride is the only chlorinated solvent presently being used. The patent literature abounds with

TABLE 1

SOLVENTS LISTED IN U.S. PATENTS

Methylene Chloride
Dichloroethylene
Trichloroethylene
Chloroform
Dichloromethane
Tetrachloroethylene
Carbon Tetrachloride
Dichlorobenzol
Ethylene Chloride
Isopropylchloride
Dichlorobenzene
Various Fluoronated Hydrocarbons
Mixed Halogenated Hydrocarbons

Benzene
Acetic Ether
Sulfuric Ether
Toluene
Ketones
Alcohols
Aliphatic Hydrocarbons
Esters
Paraffin Oil
Vegetable Oils
Coffee Oil

Ammonia
Carbon Dioxide - Liquid & Supercritical
SF₆
Lime - Soda Solutions
Mineral Acids

Unlike many solvent degreasing and extraction processes in which the presence of water is harmful, solvent extraction of green beans requires the introduction of additional water. This can be accomplished via hot water soaking, direct steaming, water addition to the solvent, or various combination of these techniques. A minimum water content of 18% is required and as much as 55% moisture is used to aid solvent extraction. It is claimed that moisture softens and opens the cellular structure of the green beans allowing caffeine to diffuse more readily. Additional evidence exist that caffeine is chemically bound with chlorogenic acid, found in coffee, and potassium to form a complex potassium - caffeine - chloroginate soft. Water is required in the solvent extraction, probable to free caffeine prior to solution in the non-polar solvent.

The basic steps in solvent extraction of caffeine from green beans are shown in Figure 1 for a semi-continuous process. Fresh green coffee beans are steamed for 1/2 hour with a resulting moisture of 16 to 18% in the first column of a battery of columns. This is followed by a prewetting step to increase the coffee bean moisture to above 40% by weight. The now steamed and prewetted green coffee beans are then countercurrently extracted by a solvent, usually methylene chloride, at temperatures between 120 and 250 F. The column from which most of the caffeine has been removed (97 to 98%) is isolated, solvent drained, and then steam stripped to remove all residual solvent. The decaffeinated beans are discharged from the column and dried. The caffeine-rich solvent is evaporated to recover the caffeine and other soluble material and the clean solvent is recycled to become the feed to the premoistened green beans rich in caffeine. The following operating conditions are cited in a U.S. patent.

Steaming: 30 minutes at 230°F
 Prewetting: 150°F to 42% water by weight.
 Caffeine Extraction: Methylene Chloride at 150°F for 10 hrs. 4 lb methylene chloride/lb green coffee beans.
 Steam Stripping: 1.5 hr

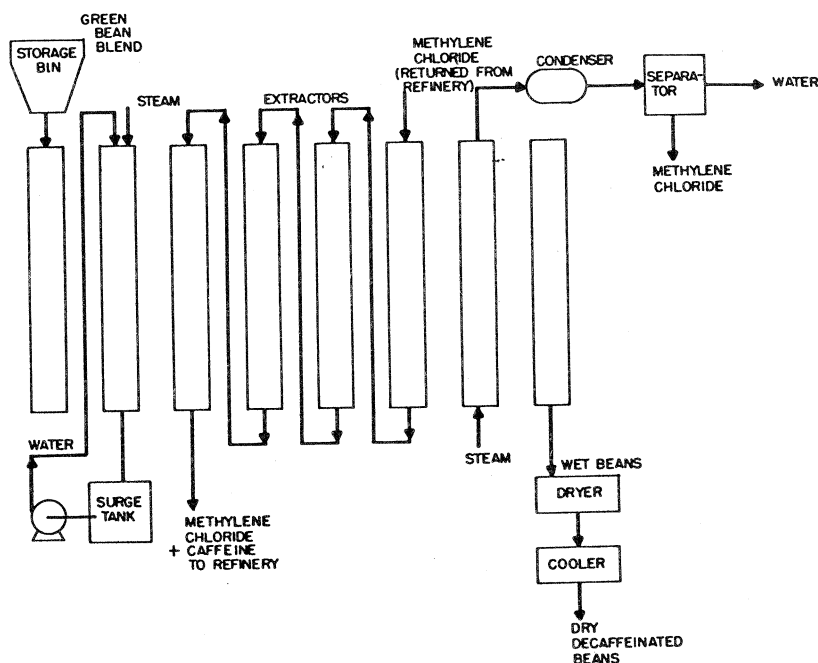

FIG. 1. Solvent decaffeination.

WATER DECAFFEINATION

Berry and Walters of General Foods in 1941 filed a decaffeination invention using a water extract of green beans in equilibrium with the green beans, except for caffeine. Advantages claimed in the invention are greater extraction rates, elimination of water-insoluble waxes extracted by the solvent, purer caffeine in a caffeine recovery system, and less heat treatment of the coffee beans by the elimination of the solvent stripping step because there is no direct solvent contact with beans. A flow diagram of the water decaffeination process is shown in Figure 2.

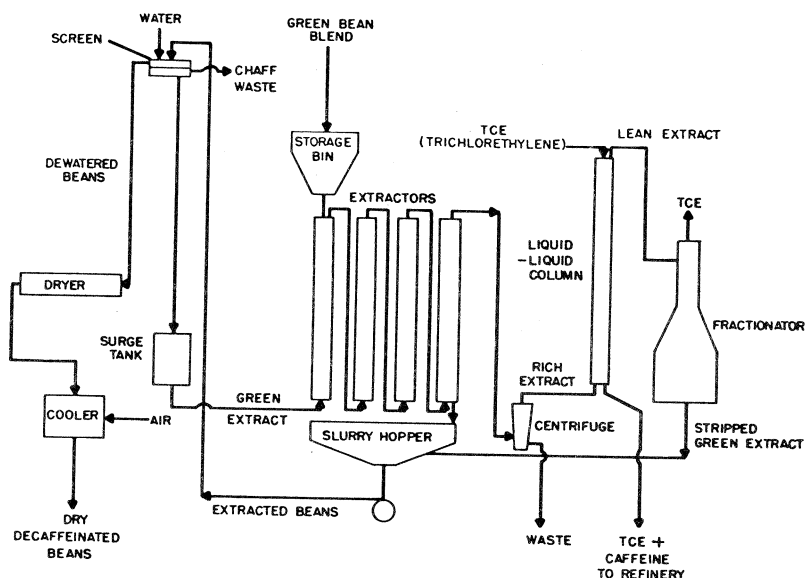

FIG. 2. Water decaffeination.

In the water process a battery of columns is used in which green beans are contacted countercurrently with water extract containing about 15% solids other than caffeine. As the extracting liquid moves through the extraction zone countercurrently, water is preferentially absorbed by the beans. Solids concentration leaving the extraction system may be as high as 30%. The water extract removes about 98% of the caffeine in about 8 hours of residence in the columns. Moisture content of the decaffeinated beans is about 53% by weight. Adhering soluble solids on the decaffeinated wet beans are washed with fresh water to eliminate drying problems and to minimize solids loss. This wash water is added to the caffeine-free water extract to bring the concentration back to the starting level of about 15% solids. Finally, the decaffeinated green coffee beans are air dried and processed in the conventional manner to produce decaffeinated regular coffee or decaffeinated instant coffee.

Extract, rich in caffeine (0.5% by weight) after centrifuging to remove suspended solids such as coffee chaff, is contacted with a solvent, such as methylene chloride, to selectively transfer caffeine. Liquid-liquid packed columns have been used to reduce the caffeine content of the green extract to about 0.05%. More recently, rotating disk contactors have proven to be more efficient and versatile than packed columns. The caffeine-rich green extract rises through the dense methylene chloride continuous phase at temperatures around 180°F to take advantage of higher caffeine distribution coefficients at the elevated temperatures. Drop size of the extract is controlled by the rotary disk speed. The solvent to extract ratio is about 4 to 8 to effect 98% caffeine removal. The caffeine lean extract has dispersed and dissolved solvent in it that must be removed before recontact with fresh coffee beans. Solvent stripping is usually performed in a distillation column with feed to the top tray with reboiling and/or direct steam injection at the bottom to insure complete solvent removal. Overs from the column are at the azeotropic composition for the solvent, 98.5% by weight for methylene chloride, unless excess steam is used. The solvent, now rich in caffeine exiting from the liquid-liquid column is regenerated in the caffeine refining system described below. It is extremely important that all waste and exhaust streams be extremely low in solvent contact to meet legal environmental requirements as well as conserve solvent.

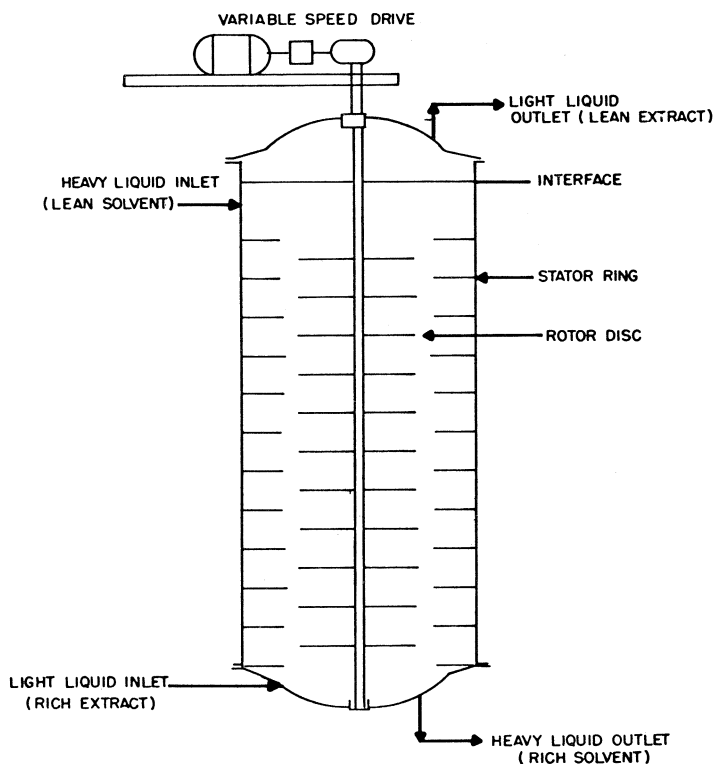

FIG. 3. Liquid-liquid extractor (rotating disk contactor).

CAFFEINE REFINING

The purity of the caffeine in the solvent from either of the two previously described decaffeination processes can be as low as 70% by weight. Economic production of pharmaceutical grade caffeine requires multiple stages for increasing its purity. Difficulties in refining are due to the various contaminants such as coffee waxes and oils as well as caffeine-like water-soluble material that imparts a dark color to a coarsely granular crystal instead of the desired white, needle-shaped crystals of pure caffeine.

The basic process used for refining caffeine derived from coffee was invented in 1948 by Shuman. This process combines a number of purifying steps (shown in Figure 4) to produce economically U.S.P. grade caffeine.

Most of the solvent containing the caffeine is evaporated and returned to the extraction process. Remaining solvent is steam distilled and the sludge that forms is dissolved with recycled mother liquor from a centrifugal step later in the process. Activated carbon, recycled from a finishing step before final crystallization, is added to remove most color contributing impurities. The slurry is filtered and the spent carbon is discarded or returned for reactivation. At this point the caffeine is 80 to 90% pure. A crystallization step followed by centrifugation results in two streams. The crystals are redissolved for an additional purification step and the mother liquor is contacted with pure solvent to recover all residual caffeine. The decaffeinated mother liquor is discarded and the solvent containing recovered caffeine is sent to an evaporator where it mixes with feed solvent. Fresh activated carbon is added to the redissolved crystals. After filtration the carbon is recycled to the first finishing tank.

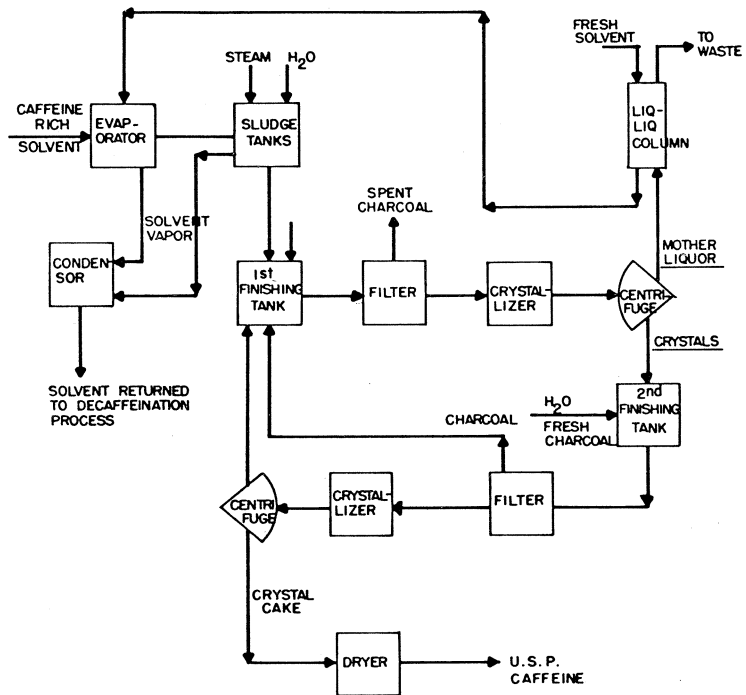

FIG. 4. Caffeine refining process.

A second crystallization step followed by centrifugation yield a mother liquor that is recycled to the first finishing tank and a caffeine crystal cake. The cake is air dried and broken to yield U.S.P. grade caffeine.

BIBLIOGRAPHY

1. SIVETZ, M. and COOK, H.E. "Coffee Processing Technology", AVI Publishing Co., Connecticut.
2. U.S. Patent No. 897,763 9/1/08
MEYER, J.F., ROSELIUS, L., and WIMMER, K.H.
"Removing Caffeine from Coffee".
3. U.S. Patent No. 3,843,824 10/22/74
ROSELIUS, W., VITZTHUM, O., and HUBERT, P.
"Method for the Production of Caffeine Free Coffee Extract".
4. U.S. Patent No. 2,933,395 4/19/60
ADLER, I.L., and EARLE, E.L.
"Process for Preparing a Decaffeinated Soluble Coffee Extract".
5. U.S. Patent No. 3,769,033 10/30/73
PANZER, H.P., YARE, R.S., and FORBER, M.R.
"Green Bean Decaffeination Employing Fluorinated Hydrocarbons".
6. U.S. Patent No. 3,806,619 4/23/74
ZOSEL, K.
"Process for Recovering Caffeine".
7. U.S. Patent No. 3,682,648 8/8/72
MITCHELL, W.A., and KLOSE, R.
"Green Coffee Decaffeination Using Edible Ester Solutions".
8. U.S. Patent No. 3,700,464 10/24/72
PATEL, J.M., WOLFSON, A.B., and LAWRENCE, B.
"Decaffeination Process".
9. HORMAN, I., AND VIANI, R.
J. Food Science 37, 925-7 (1972).
10. U.S. Patent No. 3,671,263 6/20/72
PATEL, J.M., and WOLFSON, A.B.
"Semi-Continuous Countercurrent Decaffeination Process".
11. U.S. Patent No. 2,309,092
BERRY, N.E., and WALTERS, R.H.
"Process of Decaffeinating Coffee".
12. U.S. Patent No. 3,361,571 1/2/68
NUTTING, L., and CHONG, G.S.
"Continuous Process for Producing Decaffeinated Beverage Extract".
13. "How Much Caffeine in the Cup?", ALAN W. BURG, Tea & Coffee Trade Journal, January 1975.

UTILIZATION OF COFFEE PULP AS ANIMAL FEED



J. E.
Braham

R. BRESSANI, J. E. BRAHAM

Institute of Nutrition of Central America and Panama (INCAP)

Guatemala, Central America

I. INTRODUCTION

Coffee beans have been for a long time one of the most important crops in several countries in Latin America and other parts of the world. Because of the nature of the coffee processing industry and the economic value of the coffee beans, very little attention has been given to the by-products in the past. However, due to various problems, such as disposal, pollution of the environment, economy of coffee production, and the need for feed ingredients has stimulated renewed interest in the utilization of coffee-processing by-products in Latin America.

Until very recent, research activities were very limited in scope, emphasizing the use of coffee pulp as an animal feed. As early as 1944, research reports were published on the use of coffee pulp as a feed ingredient for dairy cattle, with apparent good results (1). Since then, other reports on the use of coffee pulp as an animal feed have been published (2-9). Many of these reports are contradictory in nature, however, the potential of coffee pulp as an animal feed was suggested in some of them, although problems were encountered in its use. Reports on other uses have also been published, however, economic uses are still to be developed (10).

The present report attempts to review the advances made on research being carried out by INCAP and sponsored by IDRC to utilize coffee cherry by-products as components of animal feeds. The first part of the manuscript reviews the chemical aspects of the by-products; it is followed by the nutritional evaluation of coffee pulp as a feed component in rations for broilers, swine and cattle and ends by describing the alternatives so far available for processing and how it affects its nutritional value.

II. THE BY-PRODUCTS OF COFFEE CHERRIES

Even though the two main coffee cherry by-products, namely coffee pulp and hulls, are well known in coffee-producing countries, it was deemed of interest to describe them before going into their potential uses.

A cross section of the coffee cherry is presented in Figure 1. The pulp is made of

a relatively thick layer of spongy cells. Immediately next to the pulp a layer of mucilage is found, and then next to the mucilage the hulls enclose the coffee beans.

During harvesting, the cherries are taken to coffee mills, which in some countries are located at the coffee plantation while in others are centralized in town or cities. They are then dumped into a water tank to be washed with running water which transports the cherries to the pulping machines as shown in Figure 2. This operation removes the pulp from the beans which remain covered by mucilage and hulls. The beans are allowed to ferment for 48 to 72 hours, or are treated chemically to remove the mucilage, and then partially sun-dried before subjecting them to drying with hot air in a revolving drum. After drying the beans are threshed to remove the hulls.

The pulp removed from the fruit is disposed off either by throwing it into rivers or by composting and later use as a fertilizer in the coffee plantation. In centralized mills the pulp is returned to the coffee plantation at a relatively high cost, to be disposed off due to the cost of transportation.

The process described above is commonly used in coffee processing plants that have abundant water supplies, which is not the case for all centralized plants. In these, when water is limiting, it is used several times to wet-mill the cherries, operation which suggests the possibility of using the washing waters as a substrate for microbial growth. This possible use will not be discussed at this time, and is still a subject of much research.

When coffee cherries are processed the material balance obtained is shown in Table 1. The process is described on the left of the Table. The information includes the moisture content of the whole cherry and of the fractions obtained. From 1 kilo of cherries, 432 grams of coffee pulp are obtained which on a dry weight basis represent about 29% of the weight of the whole cherry. Further processing of the beans yields 61 g of wet coffee hulls or 41 g dry hulls, equivalent to about 13% of the cherry. The other by-product of interest is the mucilage which amounts to about 5% of the dry weight of coffee cherries (11). Very little differences have been found in fraction distribution between coffee varieties, localities and harvest time, except in mucilage content, which has varied from as low as 4.9% to as high as 13.7%. These variation may be due also to efficiency of system of processing.

On the basis of the entire Latin American coffee production, it is estimated that there are approximately over 1.5 million metric tons of dry coffee pulp available, and about 0.5 million metric tons of hulls. Likewise, the quantities of mucilage are quite large. Obviously, these quantities have some economic significance and should serve a useful purpose in coffee producing countries. It would appear that the limiting factors in the effective use of the by-products from coffee are in the processing of the fruit which has not changed over the years to produce coffee beans, and in the lack of continuous research on the by-products.

Table 2 shows the gross chemical composition of coffee pulp. Three groups of analyses are shown corresponding to fresh and dry pulp, and to a sample of pulp as found two to three days after being obtained by separation from the beans. Attention is called to the high water content which for purposes of utilization constitutes a problem in its handling, transportation, processing and direct use as an animal feed. When dried, the material contains around 10% crude protein, 21% crude fiber, 8% ash and 44% nitrogen-free extract. These values would change, of course, with variety, soil composition, altitude, and agricultural practices.

Table 3 summarizes the average content of other organic compounds in coffee pulp which may determine its potential as an industrial raw material or as a feedstuff. It is noteworthy the content of tannins, caffeine and chlorogenic and caffeic acids. All of these chemicals may have untoward effects on the performance of animals fed feed-stuffs containing them. On the other hand, some of these substances can be extracted for specific applications. For example, studies have been carried out by us to extract

caffeine from coffee pulp with success (12). Results of the fractionation of cellular walls and structural polysaccharides in coffee pulp are shown in Table 4. A cellular content of 63% suggests that the material has a relatively high level of nutrients. The levels of lignocellulose, hemicellulose, cellulose and lignin indicate that the product is superior to various types of feeds. Of the protein, about 3% is found in a lignified form, probably not readily available (13). The mineral breakdown of the ash fraction is shown in Table 5. The Ca/P ratio leans toward calcium, however, the availability of either is not known. Attention should be drawn to the high potassium concentration, which could very well have important implications in the uses given to coffee pulp. Levels of minor elements are quite low (11).

Table 6 summarizes the average amino acid content of two samples (11). For purposes of comparison, the amino acid content of other agricultural by-products is also presented. It is of interest to note the relatively high level of lysine present in coffee pulp, which is as high as that found in soybean meal on a per gram of nitrogen basis. Coffee pulp protein is deficient in sulfur-containing amino acids. At present, the biological availability of these amino acids is not known. This is an aspect which requires some investigation because of the relatively high tannin content in coffee pulp, and the known fact that tannins react with protein making its amino acids biologically unavailable to the animals. Amino acid content accounts for about 60-65% of the total nitrogen in coffee pulp. Likewise, caffeine accounts for about 15% of the total, while niacin, trigonelline and nitrogen bases make the difference to 100%. This factor has not been appreciated in the past and studies are now underway to elucidate the nutritional significance of this fact. Therefore, the true protein of coffee pulp has also been obtained from the other two fractions, the hulls and the mucilage. These, however, will not be discussed at this time, except to indicate that our results demonstrate very little potential of coffee hulls as a feedstuff. On the other hand, the mucilage could be useful as a raw material for pectins and some research along these lines is underway.

II.1 Coffee Pulp as an Animal Feedstuff

Experimental feeding trials

a. Coffee pulp in swine feeding

The chemical composition and amino acid content of coffee pulp suggest that it has good possibilities as a source of nutrients for swine feeding, although its major limitation is its high crude fiber content.

Studies designed to learn of the possibilities of using coffee pulp in swine feeding were carried out with diets containing 18, 15 and 12% protein. These were fed to growing swine from 12-30, 34-60 and 65-90 kg body weight, respectively.

At each level of protein, the diets contained 0, 8.2, 16.4 and 24.6% sun-dried and ground coffee pulp, which replaced equal amounts of protein from a basic soy:maize blend. Crude fiber was equalized between diets. The same animals were used throughout the study, although at each stage, the animals were randomized into new groups. The results of the study are summarized in Figure 3. It can be seen that at each growth stage daily weight gain and feed efficiency were inversely related to coffee pulp level in the diet. However, the overall performance was relatively good. The high coffee pulp level showed a significantly lower performance. This was attributed to a decrease in total true protein on the one hand and to the low levels of true protein in coffee pulp, which became more important as protein content decreased from 18 to 12%. Likewise, the higher levels of coffee pulp also carried with it higher levels of fiber, thus decreasing feed conversion efficiency. Metabolic studies with swine (14, 15) as well as of other growth studies suggested that coffee pulp can be safely used in swine rations in amounts of 10-16% in place of corn. The economic advantages are very promising as well as the significance of reducing the competition for corn between animal and man. Commercial trials with swine are underway using 10% coffee pulp, with results highly

acceptable at present.

b. Coffee pulp in poultry feeds

As with other animal species, chick performance decreases as coffee pulp concentration in the diet increases. This is clearly shown in Figure 4. Feed efficiency also decreases as more coffee pulp is present in the diet. Likewise, as it was the case for other species there is a definite tendency for chickens to consume more water as coffee pulp increases in the diet. This is probably due to the diuretic effect of caffeine. As with swine some of the effect on growth and feed efficiency is due to an increase in crude fiber which is found in higher amounts as coffee pulp in the diet is raised, as well as to the problem of the low levels of true protein in coffee pulp, not recognized in the past. Results of a larger feeding trial with chicks is summarized in Figure 5 in which coffee pulp replaced 10 and 20% corn in a standard corn:soybean mixture. The results shown confirm previous findings in that weight gain and feed conversion efficiency are inversely related to coffee pulp level. Furthermore, there is a significant increase in feed intake as shown, suggesting that the animal is trying to compensate nutrient intake, particularly energy at the higher levels of dietary coffee pulp, which are providing higher levels of crude fiber. At present, field commercial trials with 10% coffee pulp are being conducted in our experimental farm with acceptable results so far.

c. Nutritional value of coffee pulp in ruminants

A material such as coffee pulp whose dry matter contains around 10% crude protein and less than 25% crude fiber, has a great potential as a feed for ruminants, and it is with this animal species where most studies have been conducted.

The majority of studies on the nutritive value of coffee pulp have been carried out using dry pulp to learn of its effects on growing and fattening cattle (16-22) and all have given similar results. In these studies, coffee pulp has been given to the animals in various ways. In some cases coarsely ground as part of the roughage, in others finely ground as part of a supplement and in others as silage, as will be indicated later.

Representative results of feeding coarsely ground coffee pulp as part of the ration is shown in Table 7. Levels of 0, 10, 20 and 30% were used to replace cottonseed hulls. In this 84-day trial, there is an inverse relationship in daily weight gain and coffee pulp level in the ration. Total feed intake remained relatively constant up to 20% coffee pulp in the diet and decreases with a 30% level. Feed efficiency followed a similar trend, with respect to dietary coffee pulp level. Results using higher levels with older animals are shown in Table 8. In this case the trial also lasted 84 days and levels of coffee pulp were 0, 20, 40 and 60%. As before, daily weight gain, dry matter intake, and feed efficiency were negatively correlated with coffee pulp level. Obviously, dry matter intake from coffee pulp increased which resulted in increased intakes of caffeine and tannins. However, other chemical components in coffee pulp also increased, making it difficult to indicate which are the factors responsible for the performance observed. One aspect of interest observed in all experiments performed is the benefits of high protein content diets and adaptation of the animal to coffee pulp level.

Up to the present time the factors responsible for the adverse effects are not known. As indicated previously, coffee pulp has relatively high quantities of caffeine which are able to decrease feed intake and the growth of the animals. This is indicated by representative results shown in Table 9. In the example shown, the two levels of synthetic caffeine added were equivalent to 30 and 60% dehydrated coffee pulp. The results show that 30% coffee pulp decreased animal performance, although not statistically so, when compared to the control. On the other hand, 0.12% caffeine, which is the amount found on the average in 30% coffee pulp did not cause any adverse effect on performance. However, when the level was duplicated, daily weight gain decreased as well as feed intake and feed conversion efficiency. In nitrogen balance and digestibility studies carried out, it was observed a high urine output in animals fed coffee pulp or caffeine. These high urine levels carried high amounts of nitrogen, which could

explain the results observed.

A similar study carried out with additions to the control diet of tannic acid in amounts of 0.75 and 1.50% was also carried out. None of the two tannic acid levels affected animal performance significantly, even though the ones that received 1.5% tannic acid in the diet were slightly less efficient. In both of these studies -caffeine and tannic acid addition- coffee pulp always resulted in lower performance than the chemicals individually, suggesting that other substances alone or in combination are effective in decreasing performance of the animals. Therefore, a study was carried out in which caffeine and tannic acid were fed together. The results are shown in Figure 6. They show progressive decrease in weight gain when the animals consumed diets with a constant level of tannic acid and levels of caffeine up to 0.24%. Feed intake and feed conversion efficiency also were affected as shown. It is known that tannins bind protein, therefore, this effect as well as the higher N excretion in urine could very well be responsible for the poor animal performance observed upon feeding high levels of coffee pulp.

Metabolic trials with ruminants carried out in our laboratories permitted the estimation of some nutritional characteristics of coffee pulp (23). These are shown in Table 10. The values obtained for dry matter, organic matter, crude fiber and energy digestibility are comparable to values from other forages. However, protein digestibility is lower than that found for grasses and feeds of such a nature. The low protein digestibility value is probably due to free phenols which are oxidized, and to tannins binding protein and making it unavailable to the rumen flora of the animals. Various other studies have been carried out which have permitted to recommend not more than 30% coffee pulp in the feeding of ruminants. The general observations made in the course of the studies performed when feeding 30% and over of coffee pulp are shown in Table 11. These are, reduced dry matter intake, feed efficiency, daily weight gain, and nitrogen retention due to a high urine output accompanied by high water intake. These may be the reasons for the beneficial effects of high protein diets. Of much interest is the observation made by several workers as well as by our studies on the beneficial effects of feeding green forages or grass silage with coffee pulp. Although advances have been made, it is essential to continue the research in the utilization of coffee pulp.

III. PROCESSING OF COFFEE PULP AS A FEED

The main problem in the utilization of coffee pulp before its use as an animal feed is its high water content which interferes with its transportation, handling and preservation. Therefore, the aspects related to the stabilization of coffee pulp before its use as an animal feed are of great practical importance, which may affect its chemical composition and nutritive value, its acceptability and its economics. Attention has thus been given to the problem, and two approaches have been considered. These are presented schematically in Figure 7.

The wet coffee pulp is ensilaged and used as such or mixed with other silages or green chopped forage, in one case, or it is dehydrated and used in the other, as such, mixed with other forages or as an ingredient in compounded feeds. A combination of the two approaches is also recommended.

III.1 Ensilaging

Coffee pulp silage is an adequate and a practical solution to the problem of high moisture content and its implications of coffee pulp. This method of preservation and utilization has been studied extensively by INCAP, however, many more studies must be performed to be able to understand the process, and to recommend appropriate technologies to develop an improved product.

The steps for making coffee pulp silage as practical in our Experimental farm are described in Figure 8. The variations in this process which have been studied

include the addition of 3-6% sugar cane molasses, or molasses with 4-6% wheat bran, the above with brewer's yeast, or in combination with green forages such as grass or corn.

Coffee pulp containing about 80% water is transported to the site where the silos are located. About 4-5% of the water is lost, this amount representing the water carried by the pulp during removal from the coffee grains. Additional moisture may or may not be removed before placing the pulp into the silos. Every 12 inch layer of pulp is then sprayed with sugar cane molasses with or without the other additions, and then it is pressed. When the material is well packed into the silo, each cubic foot weighs 64-67 lbs (24). The silo is then sealed air-tight and the material ensilaged can be preserved very well for long periods of time.

III.1.1 Chemical composition

The gross chemical composition of coffee pulp silage made with the addition of sugar cane molasses as shown in Table 12, is practically the same as that of fresh coffee pulp, however, levels of tannins and of caffeine usually decrease. Consistent changes have not been observed in crude fiber fractionation.

Using pilot plant silos, studies have been carried out to measure changes in pH, soluble sugars, protein and mucilage from three types of silage, the control, with added sugar cane molasses, and with wheat bran. Representative results are shown in Table 13. The pH increased in the control, remained relatively constant in the silage with molasses and decreased in the silage with molasses and wheat bran. Soluble sugars decreased in all three cases, while protein within silage type remained constant. Of particular interest is the behavior of the material analyzed as mucilage which tended to increase in all cases, up to 90 days, and decreased at the end of 120 days. The significance of these findings is still being investigated. Changes in volatile fatty acids are shown in Table 14. Lactic acid decreased in all cases, but slower when wheat bran was included. In other studies a high lactic acid content was found during the second and third week after ensilaging. Acetic and propionic acid increased with respect to time in all three types of coffee pulp silage with some differences in the end. As was indicated before, additional studies are needed to understand, influence and control the process to insure quality in the final product.

III.1.2 Nutritional value

In spite of the changes observed during ensilaging of coffee pulp, its nutritional value remains for all practical purposes similar to that of fresh coffee pulp. An example is shown in Table 15 for coffee pulp ensilaged for 4 and 14 months, fed at a 30% level to young ruminants. Animal performance was essentially the same between dehydrated fresh coffee pulp and dehydrated coffee pulp silage as judged by weight gains and feed conversion efficiency. Therefore, the advantage of ensilaging is to be found in the convenience it offers to preserve the pulp for long periods of time, to be used when needed.

III.2 Dehydration

Two methods of dehydration have been studied. One is solar dehydration and the second mechanical hot air dehydration.

III.2.1 Solar dehydration

For sun dehydration, the material is spread on a clean surface to a thickness of about 5-8 cm. It is mixed 3 to 4 times daily and in about 24 to 30 hours moisture has been reduced to almost 12%, moisture level adequate for storage and preservation. During dehydration the color of coffee pulp changes from the dark red to a dark brown color. This, however, can be controlled by spraying with solutions of sodium metabisulfite at 1.5 - 2.0% solutions. Most of the studies carried out by INCAP have been with sun-dehydrated coffee

pulp. Results indicate that storage time decreases the antiphysiological effects, at least in respect to mortality rates in rats. It has been observed that caffeine concentration decreased to about 0.45%.

Sun-drying represents the cheapest way to dehydrate pulp, however, there are various disadvantages, such as large area to spread the pulp, time involved, and color changes. Large lots have been commercially produced in El Salvador at a price of \$2.50/100 lbs. As indicated before, when coarsely ground, it can be mixed with other forages and fed mixed with molasses, or it can be ground more finely to be included in compounded feeds to be used as a supplement.

III.2.2 Mechanical hot air dehydration

A second approach to dehydration is by means of heated air. Figure 9 describes the events taking place. The coffee pulp is transported to the plant and mixed with lime to favor water removal upon a continuous pressing operation. The pressed material is then disintegrated and transferred to a rotating tunnel drier yielding the dry pulp. This can be left as such or ground, and stored. With heated air, results of our studies indicate that by using 1.5 lbs of coffee pulp per square foot, with an air temperature of 90°C and 604 lb of air/min coffee pulp can be dehydrated in 60 minutes.

The mixing of coffee pulp with calcium hydroxide followed by a continuous pressing step to reduce moisture levels significantly is shown in Table 16. Maximum amounts of lime vary between 0.6 and 1.0% of the fresh weight of the pulp. Up to the present time nothing has been done with the press liquor. This is then followed by dehydration in a drum dryer or in a tunnel dryer. The material resulting from this type of processing has the best appearance of all products with some highly desirable characteristics, particularly if treated previously with sulfite.

These processing operations served to a very large extent in making possible the development of an industrial plant built in San José, Costa Rica by the firm Pulpa de Café, S. A. This plant operated early in 1980 for the late coffee harvest and will start again in August 1980. Samples from the January 1980 dehydration trials have been analyzed with results not different than those previously shown for sun-dehydrated pulp, except for a slightly lower protein content, around 9.0%, and for a pH of 9.5 as it would be expected. Feeding trials will be conducted as soon as the product becomes available.

In summary, it has been shown that coffee pulp can be used as a feed for poultry, swine and cattle, at levels not greater than 10, 10 and 30% of the diet with present types of materials. There are gaps of information still needed to make better use of this by-product for the purposes discussed. These are knowledge on the non-protein nitrogen components, fate of mucilage during digestion, and the identification of the compounds which are constraints to good animal feeding performance. Processing includes silage production and dehydration, by solar energy or hot air. More information should be obtained on both processes to optimize the nutritional quality of this important by-product.

IV. BIBLIOGRAPHY

1. Choussy, F. La pulpa de café como alimento del ganado. Anales del Instituto Tecnológico de El Salvador. 1:265-280, 1944
2. Work, S.H., Lewy van Severen y L. Escalón. Informe preliminar del valor de la pulpa seca de café, como sustituto del maíz en la ración de vacas lecheras. Café de El Salvador. 16:773-780, 1946
3. Osegueda Jiménez, F.L., R.A. Quiteño, R.A. Martínez y M. Rodríguez. Uso de la pulpa de café seca en el engorde de novillos en confinamiento. Agricultura de El Salvador. 10:3-9, 1970

4. Echavarría, G. La pulpa del café como alimento para ganado. Revista Cafetalera de Colombia. 8:3310-3313, 1947
5. Madden, D.E. The value of coffee pulp silage as feed for cattle. Thesis (Magister Scientifical). Instituto Interamericano de Ciencias Agrícolas. Turrialba, Costa Rica, 1948
6. Squibb, R.L. Present status of dried coffee pulp and coffee pulp silage as an animal feedstuff. Boletín mimeografiado, Instituto Agropecuario Nacional. Guatemala, 1950
7. Bolaños, J. R. La pulpa de café como alimento para ganado. Café de El Salvador. 23:217-218, 1953
8. Rogerson, A. Nutritive value of coffee hulls. E. African Agron. J. 20:254-255, 1955
9. Van Severen, M.L. y R. Carbonell. Estudios sobre digestibilidad de la pulpa de café y de la hoja de banano. Café de El Salvador. 19:1619-1624, 1949
10. Aguirre, F. La utilización industrial del grano de café y de sus subproductos. Investigaciones Tecnológicas del ICAITI #1-1966. ICAITI, Guatemala, C. A.
11. Bressani, R., E. Estrada y R. Jarquín. Pulpa y Pergamino de Café. I. Composición química y contenido de aminoácidos de la proteína de la pulpa. Turrialba. 22:299-304, 1972
12. Molina, M., G. de la Fuente, M. A. Baten and R. Bressani. Decaffeination. A process to detoxify coffee pulp. Agr. & Food Chem. 22:1055-1059, 1974.
13. Murillo, B., E. Estrada, M. T. Cabezas, E. Vargas, L. Daqui y R. Bressani. Composición de carbohidratos estructurales en diferentes muestras de pulpa y pergamino de café. In preparation
14. Rosales, F. Uso de la pulpa de café deshidratada en la alimentación de cerdos. Thesis (Magister Scientifical). INCAP/CESNA, Universidad de San Carlos de Guatemala, Guatemala, noviembre, 1973
15. Jarquín, R., F. A. Rosales, J. M. González, J. E. Braham y R. Bressani. Pulpa y pergamino de café. IX. Uso de la pulpa de café en la alimentación de cerdos en la fase de crecimiento y acabado. Turrialba, 24:353-354, 1974
16. Jarquín, R., J. M. González, J. E. Braham y R. Bressani. Pulpa y pergamino de café en la alimentación de rumiantes. Turrialba 24:41-47, 1973
17. Bará, M., F. M. Espinosa y M. S. Guevara. Determinación del nivel adecuado de pulpa de café en la ración de novillos. Boletín informativo. Instituto Salvadoreño de Investigaciones del Café. 92:1-8, 1970
18. Flores Recinos, F. Respuesta bio-económica de novillos en engorde alimentados con diferentes niveles de pulpa de café ensilada y proteína. Thesis (Magister Scientifical), IICA. Centro Tropical de Enseñanza e Investigación. Depto de Ganadería Tropical, Turrialba, Costa Rica, 1973.
19. Braham, J. E., R. Jarquín, J. M. González y R. Bressani. Pulpa y pergamino de café en la alimentación de terneros. Thesis (Magister Scientifical), INCAP/CESNA, Universidad de San Carlos de Guatemala, 1973

20. Estrada, Eugenia. Cafeína y taninos como factores limitantes en el uso de la pulpa de café en la alimentación de terneros. Thesis (Magister Scientifcae), INCAP/CESNA, Universidad de San Carlos de Guatemala, 1973
21. Cabezas, M. T., J. M. González y R. Bressani. Pulpa y pergamino de café. V. Absorción y retención de nitrógeno en terneros alimentados con raciones elaboradas con pulpa de café. Turrialba 24:90-94, 1974
22. Cabezas, M. T., B. Murillo, R. Jarquín, J. M. González, E. Estrada y R. Bressani. VI. Adaptación del ganado bovino a la pulpa de café. Turrialba 24:160-167, 1974
23. Vargas, E. Valor nutritivo de la pulpa de café. Thesis (Magister Scientifcae), INCAP/CESNA/Universidad de San Carlos de Guatemala. Guatemala, noviembre, 1974
24. González, J. M. Boletín informativo de la División de Ciencias Agrícolas y de Alimentos del INCAP. VIII. Preparación de ensilaje de pulpa de café. AGA, 16:16-19, 1973

Fig. 1

CROSS SECTION OF COFFEE CHERRY

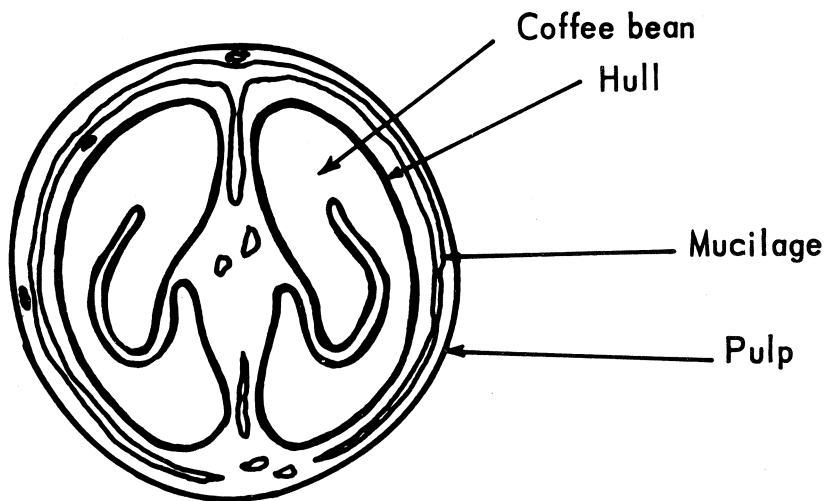

Incap 75-461

Fig. 2 WATER USAGE IN SOME CENTRAL COFFEE MILLS IN CENTRAL AMERICA

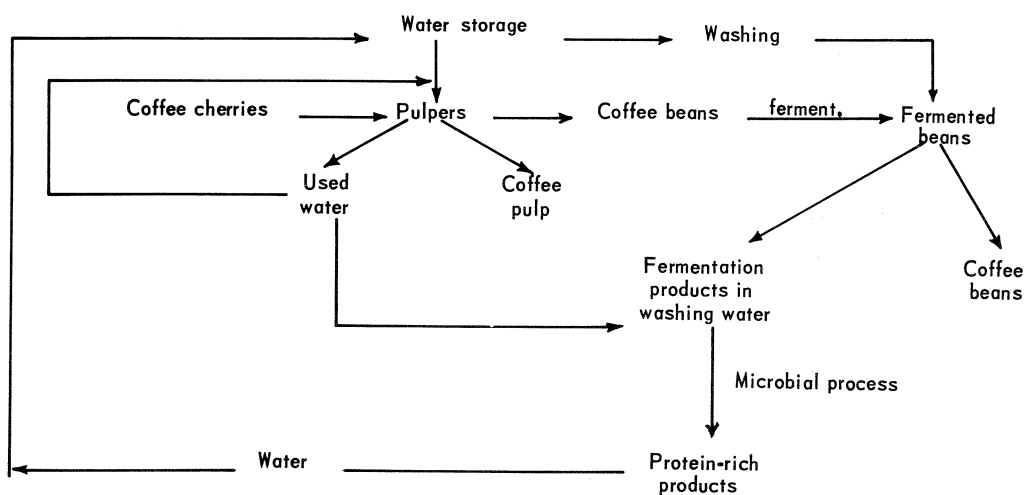

Incap 75-466

Fig. 3 PERFORMANCE OF SWINE FED DIFFERENT LEVELS OF COFFEE PULP

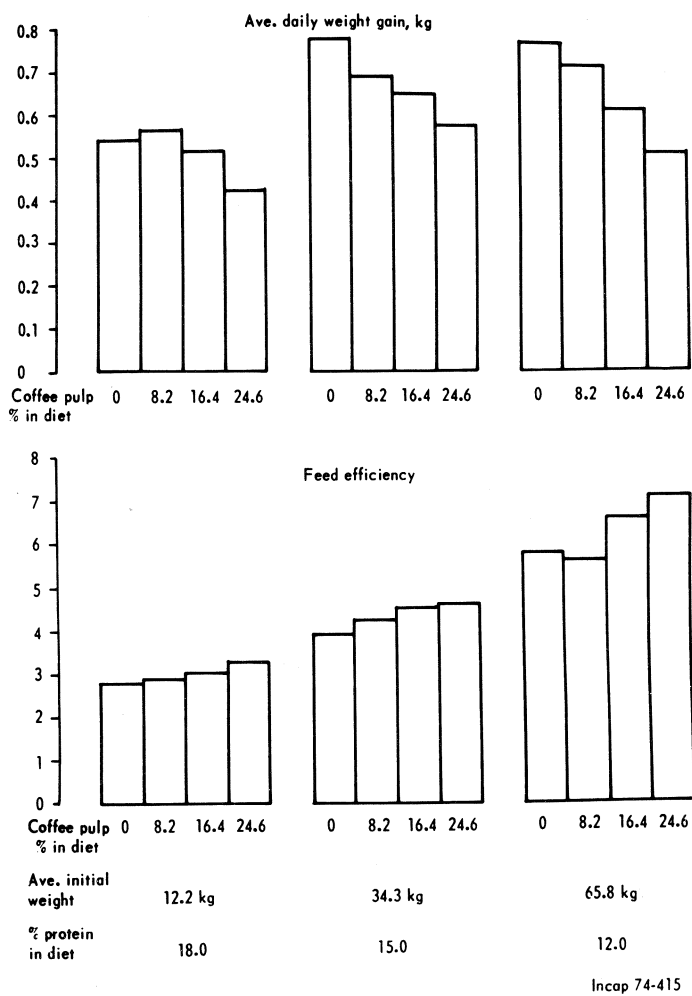

Fig. 4 EFFECT OF COFFEE PULP IN DIETS FOR CHICKENS

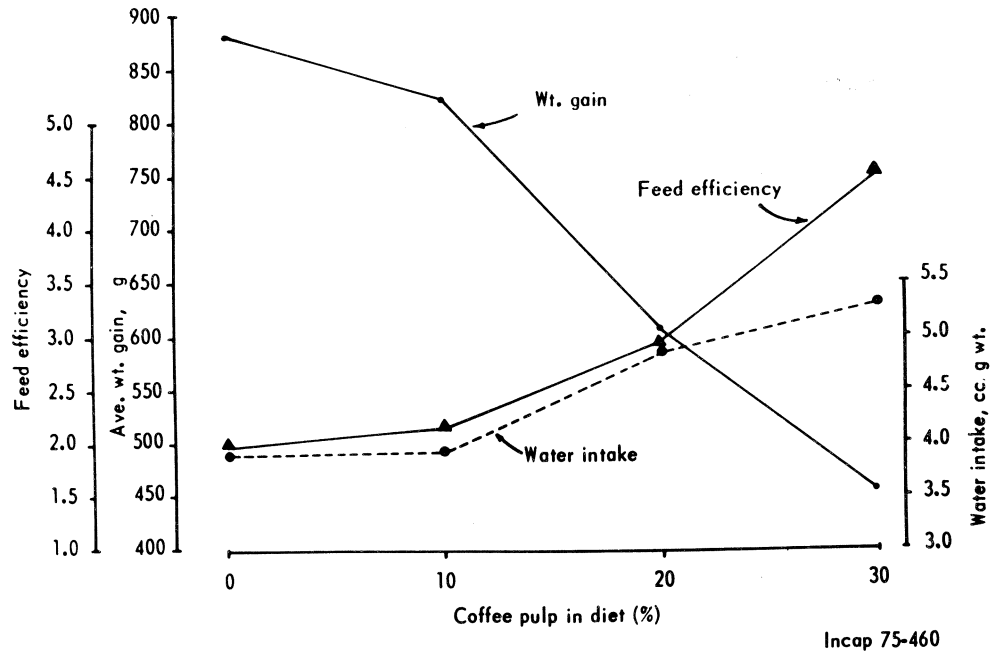

Fig. 5 EFFECT OF COFFEE PULP INCREASING LEVELS IN BROILER RATIONS

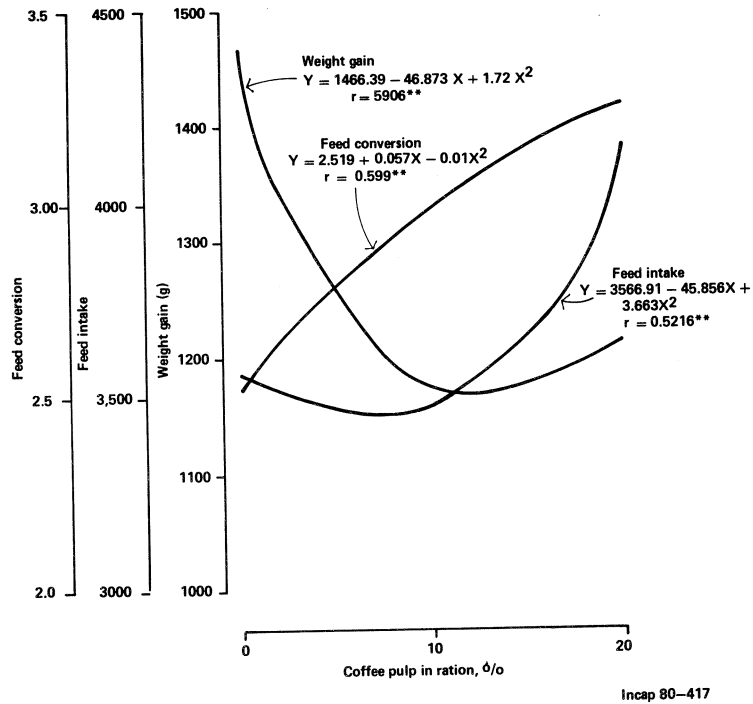
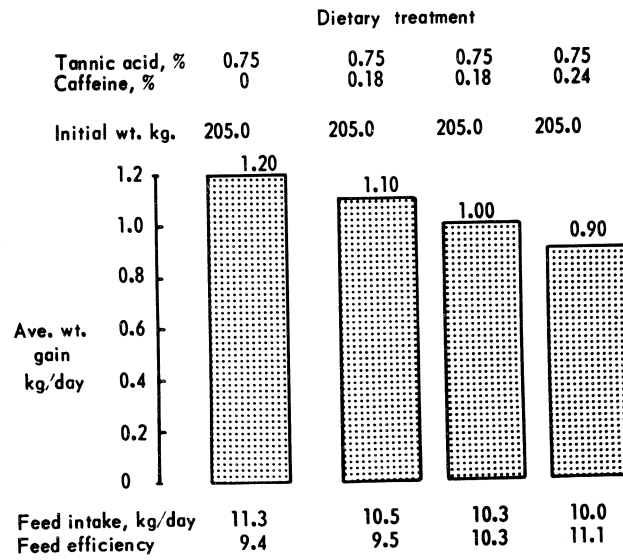
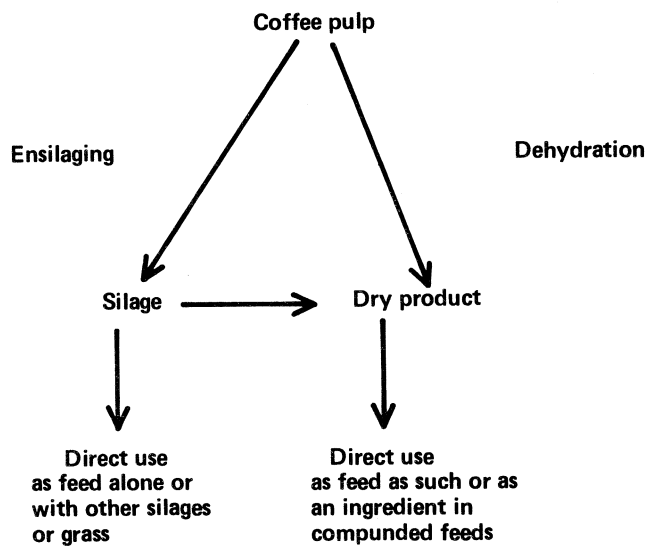

Fig. 6 EFFECT OF CAFFEINE AND TANNIC ACID ON CALF PERFORMANCE



Incap 75-462

Fig. 7 HANDLING OF COFFEE PULP



Incap 80-416

Fig. 8 ENSILAGING OF COFFEE PULP

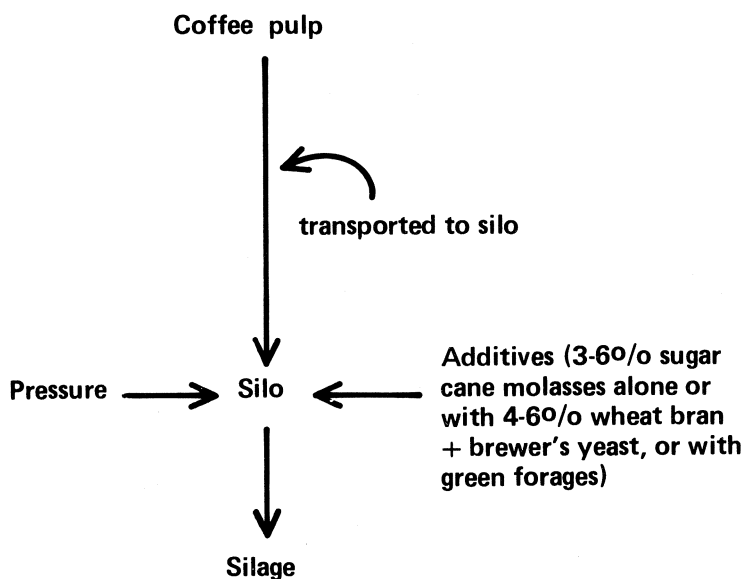

Incap 80-415

Table 1

MATERIAL BALANCE FROM COFFEE CHERRY PROCESSING

	Fresh wt. g.	o/o wt.	Moisture o/o	Dry wt. g.	o/o
Coffee cherry	1000	100.0	65.5	345	—
↓ pulper					
Coffee pulp	432	43.2	77.0	99	28.7
+					
Coffee beans + mucilage + coffee hulls	568	56.8	56.0	250	72.2
↓ Fermentation and washing					
Mucilage	—	—	—	17	4.9
+					
Coffee beans + coffee hulls	450	—	50.0	225	—
↓ Dehulled					
Coffee hulls	61	6.1	32.0	41	11.9
+					
Coffee beans	389	38.9	51.0	191	55.4

Bressani et al., Turrialba, 22:299, 1972.

Incap 80-400

Table 2 **CHEMICAL COMPOSITION OF COFFEE PULP**
(o/o)

	Fresh	Dehydrated	Naturally fermented and dehydrated
Moisture	76.7	12.6	7.9
Dry matter	23.3	87.4	92.1
Ether extract	0.48	2.5	2.6
Crude fiber	3.4	21.0	20.8
Crude protein N x 6.25	2.1	11.2	10.7
Ash	1.5	8.3	8.8
Nitrogen free extract	15.8	44.4	49.2

Incap 80-401

Table 3 **CONTENT OF OTHER COMPONENTS IN**
COFFEE PULP

Component	o/o dry weight
Tannins	1.80 – 8.56
Total pectic substances	6.5
Reducing sugars	12.4
Non-reducing sugars	2.0
Caffeine	1.3
Chlorogenic acid	2.6
Total caffeic acid	1.6

Incap 80-402

Table 4

**CELLULAR WALL CONSTITUENTS AND
STRUCTURAL POLYSACCHARIDES IN
COFFEE PULP
(g 0/o)**

Cellular content	63.2
Neutral detergent fiber	36.8
Acid detergent fiber	34.5
Hemicellulose	2.3
Cellulose	17.7
Lignin	17.5
Lignified protein	3.0
Crude protein	10.1
Insoluble ash	0.4

Incap 80-403

Table 5

**ASH AND MINERAL CONTENT
OF COFFEE PULP**

Component	Content
Ash, g 0/o	8.3
Ca, mg 0/o	554
P, mg 0/o	116
Fe, mg 0/o	15
Na, mg 0/o	100
K, mg 0/o	1765
Mg	Traces
Zn, ppm	4
Cu, ppm	5
Mn, ppm	6.25
B, ppm	26

Bressani et al. Turrialba 22:299, 1972.

Incap 80-404

Table 6 **AMINO ACID CONTENT OF COFFEE PULP PROTEIN**
(g/16 gN)

Amino Acid	Coffee pulp	Maize	Soybean meal	Cottonseed meal
Lysine	6.8	1.7	6.3	4.3
Histidine	3.9	2.8	2.4	2.6
Arginine	4.9	3.1	7.2	11.2
Threonine	4.6	3.3	3.9	3.5
Cystine	1.0	1.0	1.8	1.6
Methionine	1.3	1.6	1.3	1.4
Valine	7.4	5.0	5.2	4.9
Isoleucine	4.2	4.3	5.4	3.8
Leucine	7.7	16.7	7.7	5.9
Tyrosine	3.6	5.0	3.2	2.7
Phenylalanine	4.9	5.7	4.9	5.2
Hydroxiproline	0.5	—	—	—
Aspartic Acid	8.7	—	—	—
Serine	6.3	—	—	—
Glutamic Acid	10.8	—	—	—
Proline	6.1	—	—	—
Glycine	6.7	—	—	—
Alanine	5.4	—	—	—

Bressani et al. Turrialba 22:299, 1972.

Incap 80-405

Table 7 **AVERAGE WEIGHT GAIN AND FEED INTAKE OF 78 DAY OLD CALVES FED INCREASING LEVELS OF SUN-DRIED COFFEE PULP IN THE DIET***

	Coffee pulp, % in diet			
	0	10	20	30
Initial wt., kg	90.5	89.6	89.2	90.5
Final wt., kg	170.6	167.3	155.6	146.9
Ave. wt. gain, kg/day	0.95 ^a	0.92 ^a	0.79 ^b	0.67 ^b
Feed intake, kg/day	5.9	5.9	5.3	4.5
Feed efficiency	6.2	6.4	6.7	6.7

* Duration of study: 84 days

a,b Values with different letters are statistically significant (P < 0.05).

Incap 80-406

Table 8

**WEIGHT GAIN AND FEED CONSUMPTION AND UTILIZATION BY
STEERS FED RATIONS CONTAINING DIFFERENT CONCENTRATIONS
OF DRY COFFEE PULP**

	Coffee pulp in ration, %			
	0.0	20.0	40.0	60.0
Initial weight (kg)	232.1	232.1	234.8	232.8
Final weight (kg)	354.5	335.1	301.3	238.9
Weight gain (kg/day)	1.5 ^a	1.3 ^b	0.8 ^c	0.1 ^d
Dry matter total intake (kg/100 kg wt./day)	4.1 ^a	3.7 ^b	3.2 ^c	2.6 ^d
Coffee pulp dry matter intake (kg/100 kg wt./day)	0.0	0.74	1.27	1.57
Crude protein intake (kg/100 kg wt./day)	0.58	0.58 ^b	0.48 ^b	0.38 ^c
Feed conversion*	8.0 ^a	8.2 ^a	11.0 ^a	34.9 ^b
Caffeine intake (g/100 kg wt./day)	—	3.6 ^a	6.2 ^b	7.6 ^c
Tannin intake (g/100 kg wt./day)	—	22.1 ^a	38.1 ^b	46.0 ^c

a, b, c, d: Average on the same line with different letters are significantly (P < 0.05) different.

* : Kg of dry matter intake per kg of weight gain.

Incap 80-407

Table 9

**PERFORMANCE OF 100 DAY OLD CALVES FED SUN-DRIED
COFFEE PULP OR EQUIVALENT AMOUNTS OF CAFFEINE***

	Control diet	30% Dehydr. coffee pulp		
		0.12% Caffeine	0.24% Caffeine	
Initial wt., kg	95.3	95.5	95.6	96.0
Final wt., kg	215.0	195.1	215.1	191.2
Ave. wt. gain, kg/day	1.21 ^a	1.00 ^a	1.21 ^a	0.96 ^b
Feed intake, kg/day	8.2	7.3	8.1	6.8
Feed efficiency	6.8	7.3	6.6	7.0

* Duration of study 99 days.

Amounts of caffeine equivalent to that in 30 and 60% coffee pulp (caffeine in coffee pulp, 0.40%).

a,b Values with different letters are statistically significant (P < 0.05).

Incap 80-408

Table 10

**IN VIVO DIGESTIBILITY
COEFFICIENTS OF COMPONENTS
IN COFFEE PULP (RUMINANTS)**

Component	Coefficient of digestibility, %
Dry matter	54.8
Organic matter	54.4
Crude fiber	46.9
Energy	51.1
Protein	27.0

Incap 80-409

Table 11 **GENERAL OBSERVATIONS ON THE
EFFECTS OF COFFEE PULP ON ANIMAL PERFORMANCE**

1. Reduced dry matter intake
2. Reduced daily weight gains
3. Reduced feed efficiency
4. Increased urinary output
5. Decreased nitrogen retention
6. Adaptation with respect to time
7. Undesirable effects decrease when fed with green forages
8. High protein rations decrease effects of coffee pulp

Incap 80-410

Table 12 **CHEMICAL COMPOSITION OF DRY AND ENSILAGED COFFEE PULP**

Component	Coffee pulp silage	Dry coffee pulp
Moisture, o/o	86.0	12.6
Protein, o/o*	13.6	11.2
Soluble sugars, o/o*	4.0	—
Caffeine, o/o*	0.66	1.3
Tannins, o/o*	1.89	1.80
Lactic acid, o/o*	0.038	—
Ash, o/o*	1.5	8.3
Cellular walls**	53.1	36.8
Lignin	21.2	17.5
Cellulose	27.2	17.7
Hemicellulose**	3.0	2.3
pH	4.2	—
Digestibility, o/o	55.0	54.8

* Dry weight basis.

** Percentage of dry matter.

Incap 80-411

Table 13 **CHANGES IN SOME COMPONENTS IN COFFEE PULP DURING ENSILAGING**

Days of ensilaging	pH	Soluble sugars g/100 g	Protein g/100 g
<u>CONTROL</u>			
0	4.35	10.8	12.1
60	4.28	3.1	13.9
120	5.20	2.9	12.6
<u>+ MOLASSES</u>			
0	4.38	20.1	11.4
60	4.32	3.3	14.3
120	4.30	3.4	11.1
<u>+ MOLASSES + WHEAT BRAN</u>			
0	4.45	18.4	13.4
60	4.30	3.7	14.5
120	4.30	3.9	13.1

Incap 80-364

Table 14 SOME VOLATILE FATTY ACIDS IN COFFEE PULP SILAGE
(mg/100 g)

Days of ensilaging	Lactic acid			Acetic acid			Propionic acid		
	C.P.	C.P.+M	C.P.+M+W.B.	C.P.	C.P.+M	C.P.+M+W.B.	C.P.	C.P.+M	C.P.+M+W.B.
0	0.27	0.33	0.35	0.11	0.12	0.14	0	0	0
7	0.63	0.88	1.12	0.36	0.40	0.40	0	0	0
30	0	0.28	0.38	1.41	1.76	1.78	0.22	0.14	0.16
60	0	0	0.18	1.86	2.39	2.16	0.28	0.20	0.16
90	0	0	0	1.11	4.54	3.95	0.29	0.30	0.76
120	0	0	0	0.70	3.53	4.29	0.47	0.29	0.33

C.P. Coffee pulp.
M. Molasses.
W.B. Wheat Bran.

Incap 80-412

Table 15 PERFORMANCE OF CALVES FED ON COFFEE PULP SILAGE

Age of coffee pulp silage	Aver. wt. gain kg/day		Feed intake kg/day	
	4 months		14 months	
	Control	1.21*	8.2	1.19**
30%o sun-dried coffee pulp	1.00*	7.3	0.98**	7.7
30%o dehydrated coffee pulp silage	1.06*	7.1	1.08**	7.5

* Average initial weight, 95.4 kg.

** Average initial weight, 130.9 kg.

Incap 80-413

Table 16 EFFECT OF ADDING Ca(OH)₂ TO FRESH COFFEE PULP

Ca(OH) ₂ added*	Liquor extracted	
	o/o of total	pH of residue**
0	34.5	4.5
0.2	35.5	5.8
0.6	45.0	8.9
1.0	46.5	9.6

* Holding time: 20 minutes.

** After pressing.

Incap 80-414

MICROBIOLOGICAL METHODS FOR THE DISPOSAL AND UTILISATION OF COFFEE PROCESSING WASTES

Dr M. R. ADAMS, J. DOUGAN

Tropical Products Institute, London

1. Introduction

At the Tropical Products Institute we have recently conducted a survey of microbiological methods for the disposal of the wastes from coffee processing. Here we present a brief summary of this work and the conclusions we have drawn from it.

Of the solid wastes, we considered the disposal of dry processed husks and the parchment from wet processing not to be a serious problem because of their fuel value. This is not the case however with wet processed pulp which has a high moisture content (Table 1). During the processing season it accumulates, causing an odour and fly nuisance, while drainage from heaps of pulp can pollute nearby watercourses.

Wet processing also produces a large quantity of highly polluting liquid waste (Table 2). The pollution from a factory producing a tonne of clean coffee a day has been variously estimated as being equivalent to 60,000 gallons of crude domestic sewage, or to a population of 2,000 people (1, 2).

The volumes of water used in processing vary considerably, (Table 2) this and the widely different scale of operations employed rules out the possibility of a single universal solution to the problem. However, to give some idea of the factors involved we have adopted as a model a factory producing 1 tonne of clean coffee each day. An approximate mass balance for this operation is presented in Figure 1.

The techniques we discuss can be broadly divided into conventional waste treatment processes and procedures that seek to produce a financial return through some product. The latter have tended to concentrate on the use of coffee pulp.

2. Wastewater bio-oxidation

The common feature of microbial oxidation techniques is that organic compounds in a wastewater act as growth substrates for micro-organisms. Under fully aerobic conditions the carbon in the material is largely converted into carbon dioxide and microbial cell

TABLE 1

SOLID WASTES FROM COFFEE PROCESSING

Yield from 1 Kilo fresh cherry	<u>Wet Processing</u>				<u>Dry Processing</u>			
	Pulp 400-432g				Parchment 35-61g		Husks 180g	
	Ref 34	Ref 34	Ref 34	Ref 38	Ref 38		Ref 39	
	Fresh	Dried	Naturally fermented & dried	Dry Basis	Dry Basis		<u>C.robusta</u>	<u>C.arabica</u>
Moisture	76.7	12.6	7.9	0	0		0	0
Dry Matter	23.3	87.4	92.1	100	100		100	100
Ether Extract	0.48	2.5	2.6	1-2	0.5		2.0	1.7
Crude Fibre	3.4	21.0	20.8	12-20	50		27.6	13.2
Crude Protein	2.1	11.2	10.7	4-12	1-2.5		9.2	11.3
Ash	1.5	8.3	8.8	6-10	0.5-1		3.3	6.8
Total Pectic Substances (dry basis)	6.5	—	—	6	—		6.5	—
Reducing Sugar (d.b.)	12.4	—	—	—	—		12.4	—
Non reducing Sugar (d.b.)	2.0	—	—	—	—		2.0	—
Total Sugar (d.b.)	14.4	—	—	14.0	—		14.4	—

mass (Figure 2, equations 1 and 2). This occurs naturally when the waste is discharged into a river; the concentration of organic material being reduced at the expense of oxygen dissolved in the water. When the concentration is too high oxygen is removed faster than it can be replaced, anaerobic conditions are established and the resource value of the watercourse is severely reduced. This effect has been noted as a result of the discharge of coffee processing waters (2).

The different techniques of wastewater bio-oxidation circumvent this process by supplying sufficient oxygen usually as air, so that a mixed population of microbes can reduce the organic content of the waste to an acceptable level before it is discharged.

TABLE 2

POLLUTION LOAD OF LIQUID WASTES FROM COFFEE PROCESSING

	Chemical Oxygen Demand C.O.D. (p.p.m.)	Total Solids (p.p.m.)	Biological Oxygen Demand B.O.D. 5 days at 20° C (p.p.m.)	Total Solids (p.p.m.)	Biological Oxygen Demand B.O.D. 3 days at 26.7° C (p.p.m.)
	Ref 21		Ref 8		Ref 1
Pulping Waters	13,900-28,000	13,150	1,800-2,920	4,960	2,400
Fermentation Waters	3,000-10,000	2,900	1,250-2,200	4,260	3,900
Washing Waters					
Volume of water per ton of clean coffee (galls.)	490-9,800		2,240-5,820		13,500-20,000

FIGURE 1

MODEL FACTORY - MASS BALANCE

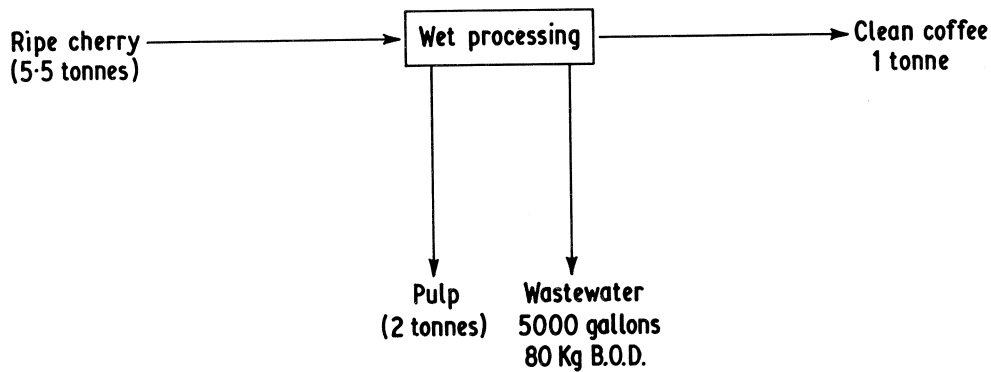

a. Biological filters

Here, a settled effluent is distributed over the surface of a bed of some inert support material and is allowed to trickle through against a countercurrent of air. A microbial film adsorbed on the support oxidises the organic constituents of the effluent which is then clarified by secondary sedimentation and either discharged or recirculated. Normally biological filters require an effluent with a BOD of around 300 ppm which can be achieved by dilution of the wastewater with treated effluent. They have been shown to be effective in the treatment of coffee wastewater in Kenya but have not been widely adopted (1).

Filters have the advantage of being relatively cheap to construct and operate but require a greater land area than some other methods. For example, a factory producing 1 tonne of clean coffee a day would require a filter containing 500-800m³ of packing material occupying an area of approximately 250-400m² (1, 3).

FIGURE 2

Ref. 40

Completely aerobic growth

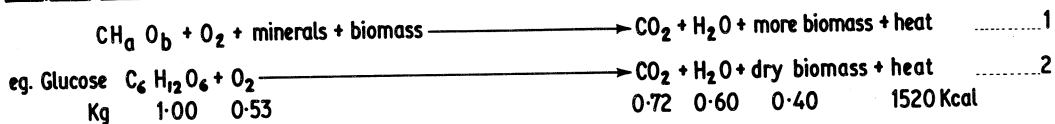

Anaerobic fermentation

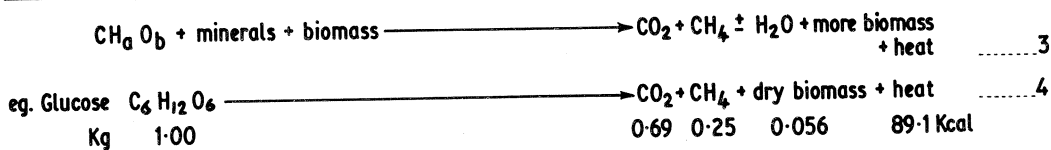

b. Rotating biological contactors (RBC)

In an RBC the mineralisation of an effluent is also performed by a microbial film. The support material is usually formed into circular vanes 1-3m in diameter centred on a horizontal axle. The axle is positioned just above the liquid level in a trough through which the effluent is passed. To oxygenate the complete film the vanes are rotated at 1-3 rpm, 40-50% of the film being immersed at any instant. These plants are very compact, a unit to produce a 90% reduction in the BOD of our model factory's effluent would occupy about 40m² of land. They do, however, have to be purchased as a complete unit and require a constant reliable power supply and more frequent maintenance than biological filters.

c. Activated sludge and oxidation ditches

Activated sludge is the term used for the community of micro-organisms that are produced as flocs in a liquid effluent when air is introduced at a high rate (4). Oxidation ditches are a modification of the activated sludge process which has been applied to the treatment of agricultural wastes (5). The effluent is aerated by a mechanical rotor which also drives the effluent around the ditch. Although very effective its running costs are higher than those of filters and RBCs (1kwh/kg of BOD removed) and they also require more frequent maintenance. An oxidation ditch to treat the effluent from the production of 1 tonne of coffee would occupy roughly 500m² of land.

d. Stabilisation ponds

Ponding or lagooning an effluent is a simple and effective method of treatment which is frequently applied when land is available. Its use in the treatment of coffee processing waters has been described (6).

Two principal types of pond are used. The anaerobic pond which does not employ bio-oxidation is essentially an open septic tank in which anaerobic bacteria reduce the BOD of an effluent by degrading its organic constituents to methane and carbon dioxide (figure 2, equations 3 & 4). Anaerobic ponds have a low surface area to volume ratio and can be used to treat large flows of strong wastes usually in conjunction with an aerobic treatment step. They do, however, suffer from the disadvantage of requiring frequent desludging and of being the source of unpleasant odours.

In the facultative pond some anaerobic decomposition does take place in the sediment at the bottom but the effluent is purified mainly by bio-oxidation mechanisms. The supply of oxygen to the bacteria is maintained by a surface layer of photosynthetic algae though one type of high-rate pond uses mechanical aerators floating on the surface.

The normal depth of a pond in tropical conditions is around 1m. If it is much deeper the pond becomes largely anaerobic, while in shallower ponds vegetation can grow up from the bottom creating conditions favourable for mosquito breeding. The loading of facultative ponds is normally described in terms of BOD applied per unit area. The loading rate of 100lb/acre recommended for the tropics (7) would mean a pond area of about 2 acres to treat our model factory's effluent. This could be reduced, however, by using a 2 pond system with both an anaerobic and a facultative pond in series.

Seepage pits which have been recommended for disposal of coffee wastewaters are a compromise solution which can be effective for small-scale operations.

3. Land disposal

The disposal of wastewaters on land is probably the cheapest effective method for treating seasonal wastes provided no transport costs are involved. When applied correctly there

will be no run-off of polluting matter into rivers and essential nutrients and water will be returned to the soil.

Although non-biological mechanisms contribute to the purification of wastewaters in soil microbial activity is usually the most important factor. The top layer of soil where conditions are aerobic acts as a natural biological filter while anaerobic decomposition takes place at deeper levels.

Coffee wastewaters have been shown to be suitable for the irrigation of coffee trees and Napier grass (2) but in fact the type of crop irrigated is of less importance than the soil's physical character. Application of an effluent at rates higher than the capacity of the soil to deal with them will result in waterlogging, odour production and inhibition of plant growth. This has been observed when a high solids coffee effluent was used but not with well-sedimented wastewaters (8).

4. Composting

Composting is a system of solid waste management where environmental conditions optimise the process of microbial degradation. The product is an easily handled solid which can be stored and applied to land without adverse effects. Frequently the process of natural anaerobic decomposition is described as composting. This is a slow process which gives rise to unpleasant odours and insect proliferation whereas a well managed aerobic composting operation should be free from these problems.

The procedure most appropriate to use with coffee pulp is windrow composting. Material is piled into long heaps about 1m high by 1m wide at the top and 1.5m wide at the base. Aeration is maintained by occasional turning of the pile which can be done either mechanically or manually. Coffee pulp should be turned at least once a day at the beginning of composting as the high moisture content can lead to compaction and the development of anaerobic conditions (9). The labour cost of this operation should not be excessive as 4-6 tonnes of material can be turned in one man-day (10). The complete operation should take 4-10 weeks.

Coffee pulp compost contains about 3.5% nitrogen and should be used as a soil conditioner rather than a fertilizer. Beneficial effects resulting from its application to crops have been noted as has the occasional absence of any observable effect (11, 12, 13). Nevertheless the use of coffee pulp compost should be regarded as a wise measure to conserve if not improve, the long-term quality of the soil.

5. Single-cell protein

The production of micro-organisms (SCP) for food and feedstuffs from agricultural wastes has received considerable attention (14). A medium produced from coffee pulp has been used for the semi-continuous propagation of the yeast Candida utilis (Henneb.) Lodder and Kreger-van Rij (15, 16) and a US Patent has described a continuous process (17).

Attempts have also been made to grow the fungus Trichoderma harzianum (Rifai) on processing wastewaters under non-aseptic conditions (18-21). Although moderately successful as a batch process it proved impossible to run on a continuous basis without infection.

As an animal feed ingredient SCP is subject to the least-cost accounting of the feed compounder and must compete with other high protein feedstuffs such as soya and fishmeal. In order to do this it has been necessary for commercial SCP producers to take advantage of the economies of scale which arise from continuous operation of very large plants producing around 10^5 tonnes per annum. To append a small SCP plant on a seasonal coffee processing operation is unlikely to prove economic. The published data indicate that a factory producing 1 tonne of coffee each day would be able to produce 41.3 kg of dry yeast a day from the waste pulp. This would be worth at May 1980 prices, £10.33.

6. Ethyl alcohol, wine and vinegar

The production of ethyl alcohol for fuel or chemical feedstock must also be ruled out for economic rather than technical reasons. Fermentation of coffee pulp extracts with yeast produces alcohol concentrations of 2.5-5.0% (22, 23) below the level considered economic

for recovery by distillation. In addition to this the production of alcohol by fermentation poses its own severe pollution problems. For every volume of alcohol (our model factory would produce 55 litres a day), 12-15 volumes of high BOD effluent would be produced, (24).

As potable alcohol commands a far higher market price its production from coffee pulp may prove feasible. The product's acceptability, however, is not easy to predict as it would be based on factors other than its chemical purity such as flavour and appearance.

There have been reports of a wine produced from coffee pulp but this appears to have been an experimental programme (25-27). Wine production would require the addition of large quantities of sugar to the must in order to achieve the necessary alcohol content.

The production of vinegar from wet processed pulp was a traditional small-scale industry in Brazil during the 1940's (28, 29) but no recent reports on the process have been traced. The larger factories were said to produce 150-200 litres a day during the season. Apparently no difficulty was experienced in obtaining sufficient sugar in an extract to give the required acetic acid concentration of 4% in the product. This may be due to the low moisture content recorded for the pulp (42.7%).

7. Biogas

The complete digestion of organic material under anaerobic conditions leads to its conversion to methane and carbon dioxide as principal products (Figure 2, equations 3 & 4). As methane is only sparingly soluble in water, it accumulates in the gas phase in concentrations greater than those normally associated with fermentation products (50-70% by volume). Anaerobic digestion is widely used in sewage works to reduce and stabilise solids, the biogas (a mixture of methane and carbon dioxide) produced being used as a source of power.

Mr T H Hutchinson has pioneered the use of anaerobic digesters on farms in East Africa (30, 31). He has found that coffee pulp is a good gas producer but only when mixed with cattle manure in a batch digester (32). This probably reflects a need for a medium which is well buffered against pH changes and represents an expensive complication for those processing operations which do not have livestock.

The potential yield of biogas from pulp can be roughly estimated using figures obtained from semi-empirical studies with similar substrates. On this basis a factory producing 1 tonne of clean coffee each day would also produce 131m^3 of biogas from pulp, equivalent in terms of its fuel value to 100 litres of petrol (33).

Despite the prodigious literature on anaerobic digestion our understanding of the basic micro-biology and bio-chemistry of the process is weak. In practice digesters have been found to have a high capital cost, require constant skilled attention and can be subject to unexplained failure. Considerable fundamental work must be done before anaerobic digestion can become a reliable means of renewable fuel production.

8. Silage

The value of fresh coffee pulp as an animal feed has been discussed (34, 35). Among the limitations on its use are its seasonal availability and poor keeping quality in the fresh state. One way of overcoming this difficulty is by converting it to silage, a process which involves the anaerobic conversion of carbohydrate to lactic acid by bacteria. This causes the pH to drop to below 4.2 which inhibits the action of other degradative organisms (36).

To make good silage from coffee pulp a preliminary pressing to reduce the moisture content and an addition of molasses to ensure rapid fermentation have been recommended (37). The process does not require expensive equipment as a simple line pit in the ground has been shown to serve well as a fermentation vessel.

9. Conclusions

The problems of waste management for coffee processing operations should be treated on an individual basis. Wherever possible, wastewaters should be treated by a system of land disposal and irrigation. If the local conditions do not permit this solution and there is insufficient land for lagooning a biological filter would probably prove most economic.

In areas where there is sufficient demand for pulp as an animal feed its use can be extended by conversion to silage. In other circumstances composting is the best solution.

REFERENCES

1. BRANDON, T.W. (1949) Treatment and disposal of waste waters from processing of coffee. *The East African Agricultural Journal* 14 179-186.
2. DIRECTOR OF WATER DEPARTMENT (1977) Recirculation of water combined with land treatment as a solution to the problem of river pollution from coffee factories. *Kenya Coffee* 42 (500) 367-373.
3. MATTHEW, P.K. (1978) The problem of water pollution in coffee plantations. *Indian Coffee* 42 343-344.
4. AINSWORTH, G. (1966) An introduction to the activated sludge process. *Process Biochem.* (4) 15-22.
5. ANDERSON, G.K. (1977) Farm and food wastes in *Treatment of Industrial Effluents*, Eds. A.G. Callely, C.F. Forster and D.A. Stafford, London: Hodder and Stoughton 378pp.
6. PAHREN, H.A. and SAENZ, R.F. (1961) Treatment of wastes from coffee processing in Costa Rica. Robert A. Taft Sanitary Engineering Centre Technical Report W60-2 17pp.
7. LOEHR, R.C. (1974) *Agricultural Waste Management*, New York: Academic Press 576pp.
8. WARD, P.C. (1945) Industrial coffee wastes in El Salvador. *Sewage Works Journal* 17 39-45.
9. BECKLEY, V.A. (1934) Organic manures with special reference to composts. Kenya Dept. of Agriculture Bulletin No 9. 45pp.
10. GOLUEKE, C.G. (1977) *Biological reclamation of solid wastes*. Emmaus, P.A.: Rodale Press. 249pp.
11. CLAUDE, B. (1979) Review on the use of coffee by-products. *Cafe, Cacao, Thé* 23 (2) 146-152.
12. PARRA, H.J. (1959) The fertilizer value of coffee pulp. *Cenicafé* 10 441-60.
13. ARANA, M.L. (1966) Chemical changes in soils periodically treated with organic material. Residual values and effects of decomposed coffee pulp on plants up to one year. *Cenicafé* 17 121-31.
14. LASKIN, A.I. (1977) in *Annual Reports on Fermentation Processes*, Ed. D. Perlman, 1 151-175.
15. AGUIRRE, F. (1966) La utilización industrial del granos de cafe y de sus subproductos *Investigaciones tecnologicas del ICAITI Nu. 1*.
16. CALLE, H. (1977) Subproductos del café. *Cenicafé, Colombia Boletín Técnico No 6*.

17. FRIES, K.W.E. (1971) Process for the continuous production of *Torula* yeast from coffee berry waste. US Patent 3, 576, 720. April 27 1971. 2pp.
18. ROLZ, C., MAYORGA, H., SCHNEIDER, S., CORDEIRO, L., MENCHU, J.F., ESPINOSA, R., and CHURCH, B. (1973) Produccion de Fungi imperfi a partir de las aguas de desecho de los beneficios humedos de cafe. ASIC 6e Colloque, Bogota.
19. ROLZ, C. (1975) Utilization of cane and coffee processing by-products as microbial protein substrates. Single-cell protein II, eds, S.R. Tannenbaum and D.I.C. Wang; Cambridge, Mass: MIT Press.
20. ESPINOSA, R., MALDONADO, O., MENCHU, J.F. and ROLZ, C (1977) Aerobic, non-aseptic growth of *Verticillium* on coffee waste waters and cane blackstrap molasses at a pilot plant scale. Biotechnology and Bioengineering Symposium No. 7 35-44.
21. AGUIRRE, F., de CABRERA, S., ESPINOSA, R., MALDONADO, O., MENCHU, J.F. and ROLZ, C. (1976) Protein from waste: growing fungi on coffee waste. Chem. Tech. 6 636-642.
22. KRISHNAMOORTHY BHAT, P. and DEEPAK SINGH, M.B. (1975) Alcohol from coffee waste. J. Coffee Res. 5 71-72.
23. ADAMS, M.R. and DOUGAN, J. Unpublished results.
24. SHARMA, K.D. (1979) Present status of alcohol and alcohol based chemicals industry in India. UNIDO Workshop on Fermentation Alcohol. Vienna.
25. ANON (1934) Making coffee wine in San Salvador. Spice Mill 37 313.
26. ANON (1940) Manufacture of coffee pulp wines. Rev. Agricola (Guatemala) 17 179-180.
27. MARDEN, L. (1944) Coffee is king in El Salvador. National Geographical Magazine 86 575-608.
28. FREISE, F.W. (1931) Preparation of vinegar from coffee fruit pulp. Ind. and Eng. Chem. 23 (10) 1108-1109.
29. FREISE, F.W. (1931) Production of vinegar from coffee husks. Dtsches Essigind, 35, 169-71.
30. ANON (1958) How gas helps coffee growers. Coffee Trade News 9 (5) 20-21.
31. ANON (1967) Methane plants. Kenya Coffee (3) 113-114.
32. HUTCHINSON, T.H. Personal communication.
33. LANE, A. (1979). Methane from anaerobic digestion of fruit and vegetable processing wastes. Food Technology in Australia 201-207.
34. BRESSANI, R., CABEZAS, M.T., JARQUIN, R. and MURILLO, B. (1974) The use of coffee processing waste as animal feed. Tropical Products Institute Conference on Animal Feeds. 107-117.
35. BRESSANI, R. and BRAHAM, J.E. (eds) Coffee pulp: composition and technology. Ottawa: International Development Research Centre. 95pp.
36. BARNETT, A.J.G. (1954) Silage fermentation. London: Butterworths 208pp.

37. MURILLO, B. (1979) Silage in coffee pulp: composition and technology, ed. R. Bressani and J.E. Braham. Ottawa: International Development Research Centre 95pp.
38. ROLZ, C. (1978) Particular problems of solid waste reclamation in developing countries. J. appl. Chem. Biotechnol. 28 321-339.
39. TANGO, J.S. (1971) Industrial utilisation of coffee and its by-products Bol. Inst. Technol. Aliment. (Sao Paulo) 49-73.
40. PIRT, S.J. (1978) Aerobic and anaerobic microbial digestion in waste reclamation. J. appl. Chem. Biotechnol. 28 232-236

CONTRIBUTION À L'ÉTUDE DE LA COMPOSITION CHIMIQUE DE LA PULPE DE CAFÉ

J. ZULUAGA VASCO, R. TABACCHI

Institut de Chimie, Université de Neuchâtel,

2000 Neuchâtel, Suisse

INTRODUCTION

La pulpe de café est, qualitativement et quantitativement, le sous-produit le plus important dans l'industrie agricole du café.

La pulpe constitue le 40 % du fruit frais (Zuluaga et al. (1)).

Pendant la période de 1978-1979, la production de pulpe de café en Colombie a été de 340'000 tonnes (2) (matériel sec); ce qui représente le 31 % de la production totale d'Amérique Latine.

La production si élevée de ce sous-produit engendre des problèmes de contamination dans les pays producteurs de café.

Quelques chercheurs (3) en Amérique centrale essayent d'utiliser la pulpe dans l'alimentation animale; mais la présence de caféine et de tannins empêchent d'incorporer plus de 20 % dans la ration alimentaire.

Les paysans latino-américains utilisent la pulpe de café comme engrais, pour la culture du café. Une recherche poussée sur la composition chimique de la pulpe est ainsi indispensable, afin de trouver sa meilleure utilisation.

Le sujet du présent travail suit les recommandations de la première réunion internationale sur l'utilisation des sous-produits du café (4) (Turrialba-Costa Rica, 1974). Lors de cette réunion, on a remarqué la nécessité d'une analyse plus détaillée dans la pulpe de café, de certains groupes de composés tels que les polyphénols et les sucres.

Dans ce but, nous avons entrepris:

- a) une détermination quantitative des différentes classes de composés phénoliques
- b) une analyse qualitative et quantitative des sucres libres dans la pulpe.

PARTIE EXPERIMENTALE

1. MATERIEL

Les échantillons de pulpe de café ARABICA, VARIETE TIPICA ROJO, ont été fournis par le centre national de recherches sur le café "CENICAFE", Chinchina, Colombie.

La moitié de l'échantillon a été lyophilisée immédiatement après la récolte et l'autre séchée au soleil.

2. METHODES

A.- Détermination quantitative des différentes classes de composés phénoliques

La détermination quantitative des différentes classes de composés phénoliques a été faite en utilisant la méthode décrite par Marigo (5), pour le fractionnement et l'estimation des composés phénoliques chez les végétaux. Nous avons introduit quelques modifications pour la détermination de tannins hydrolysables et condensés. L'analyse est faite en trois étapes:

1) Extraction

Le dispositif d'extraction est similaire à celui utilisé par Alibert et al. (6), pour l'extraction des acides phénoliques chez *Quercus pedunculata* Ehrh.

200 mg de pulpe séchée, broyée et depigmentée par 3 lavages successifs à la ligroïne (40-60°C) (3 x 10 ml) sont traités, d'abord avec un mélange d'acétate d'éthyle-éthanol (1:1 v/v) et ensuite avec de l'éthanol à 80 %. A chaque système de solvant 50 mg de metabisulfite de sodium ($\text{Na}_2\text{S}_2\text{O}_5$) par litre sont ajoutés. L'extraction est réalisée en continu à température ambiante et le solvant évaporé à 30°C sous vide (évaporateur rotatif).

L'extraction est poursuivie jusqu'à l'absence de réaction de l'extrait avec le réactif chlorure ferrique-ferriicianure de potassium. La sensibilité de ce test est de l'ordre de 0,05 µg pour les composés phénoliques (7).

L'évaporation des solvants d'extraction a basse température (30°C) et l'utilisation d'anti-oxydants réduisent le risque d'hydrolyse et d'oxydation.

2) Fractionnement des différentes classes de composés phénoliques (figure 1)

L'ensemble des produits phénoliques d'un extrait végétal peut se diviser en deux groupes principaux: a) composés phénoliques tannins, b) composés phénoliques non tannins. Chaque groupe peut se subdiviser respectivement en a) tannins hydrolysables et tannins condensés; b) flavonoïdes et phénols simples (dérivées du type ester ou ether-oxyde des acides phénoliques et coumarines). Le premier fractionnement de l'extrait total en groupes, est réalisé par précipitation des tannins au moyen de la gélatine. Les conditions optimales de cette précipitation ont été déterminées par Boudet et Gadal(8) pour l'isolement des tannins de *Quercus Sissilis* Ehrh.

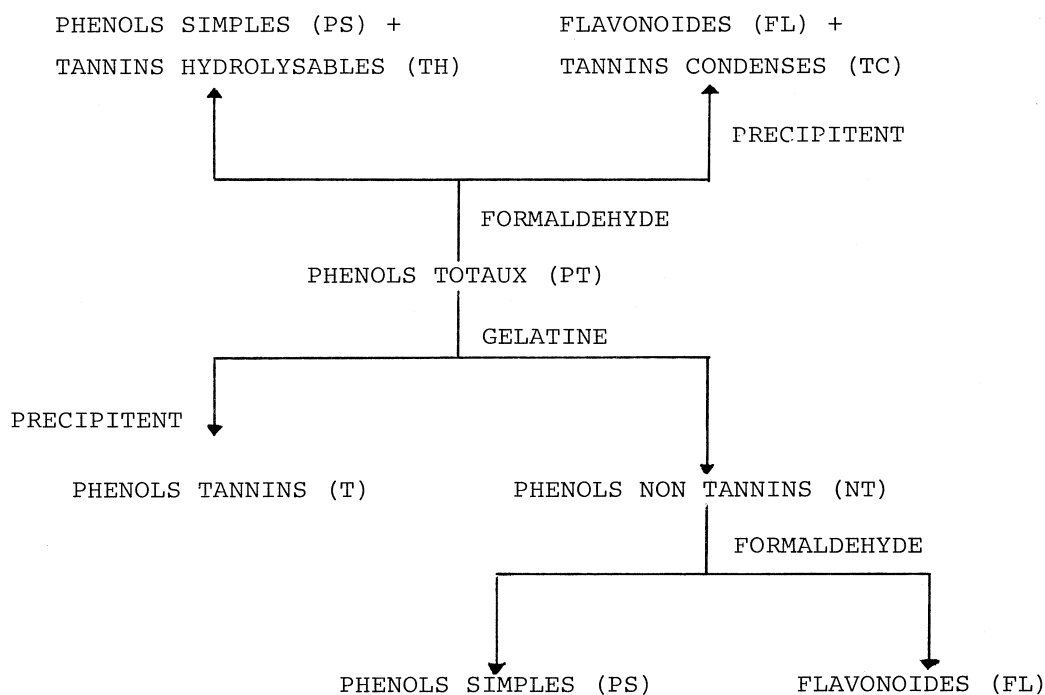

Figure 1.- Schéma de séparation en différents groupes de composés phénoliques

Nous avons utilisé une solution fraîchement préparée (1 % gélatine et 10 % NaCl); le PH du milieu étant maintenu entre 4 et 5 et la réaction poursuivie jusqu'à l'absence de floculation.

Le complexe gélatine-tannins est séparé de la fraction phénolique non-tannin par centrifugation. La gélatine présente l'avantage de ne précipiter que des tannins.

La séparation successive des groupes est faite par précipitation avec la formaldehyde (1,6 mg/ml, PH < 1, sous azote) laquelle ne précipite que des substances possédant un noyau aromatique du type phloroglucinol (meta-di-hydroxy benzene) tels que la majorité des flavonoïdes et les tannins condensés (dérivés de la catéchine). Les conditions optimales de précipitation ont été établies par Kramling et Singleton (9) pour l'estimation des phénols non flavonoïdes dans le vin.

Lorsque la réaction, avec la formaldehyde, est faite sur l'extrait total, on obtient deux fractions: l'une constituée par les flavonoïdes et tannins condensés, l'autre contenant les phénols simples et les tannins hydrolysables.

Nous effectuons cette dernière réaction sur l'extrait total, pour la détermination indirecte des tannins hydrolysables et condensés. Ces

déterminations n'ont pu être faites sur le complexe gélatine tannins, insoluble, à cause de la présence de mucilages.

3. PURIFICATION ET DOSAGE (figure 2)

Les dosages quantitatifs des phénols totaux, phénols non tannins, phénols simples et phénols simples + tannins hydrolysables sont faits, avec le réactif de Folin et Ciocalteu, par calorimétrie avec mesure de l'absorbance à 760 nm (Swain et Hillis (9)). Comme composé de référence, pour l'étalonnage, nous utilisons l'acide gallique. Les résultats sont ainsi exprimés en mg d'acide gallique pour 100 mg de pulpe sèche. Le dosage est effectué chaque fois, d'abord sur les solutions contenant les phénols (extrait total, non tannins, phénols simples, phénols simples + tannins hydrolysables) et ensuite sur les mêmes solutions traitées avec du Polyclar (polyvinylpyrrolidone = PVP) (figure 2). Ce polymère retient uniquement les composés phénoliques. Nous utilisons 2 g de PVP par 8 mg de composés phénoliques dosés à PH 3,5 (5).

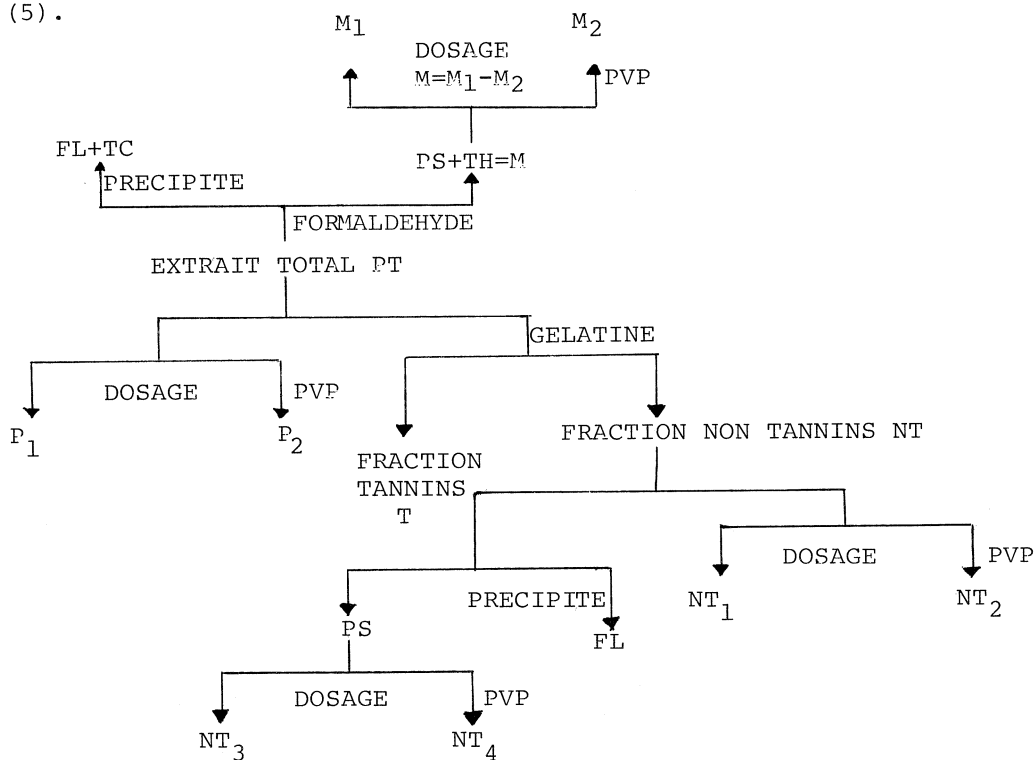

$$\text{PHENOLS TOTAUX PT} = P_1 - P_2$$

$$\text{PHENOLS NON TANNINS NT} = \text{NT}_1 - \text{NT}_2$$

$$\text{PHENOLS TANNINS T} = \text{PT} - \text{NT}$$

$$\text{PHENOLS SIMPLES PS} = \text{NT}_3 - \text{NT}_4$$

$$\text{FLAVONOIDES FL} = \text{NT} - \text{PS}$$

$$\text{TANNINS HYDROLYSABLES TH} = \text{M} - \text{PS}$$

$$\text{TANNINS CONDENSES TC} = \text{T} - \text{TH}$$

Figure 2.- Schéma de purification et dosage des différents groupes de composés phénoliques d'un extrait de pulpe de café.

B.- Détermination qualitative et quantitative des sucres libres

Les analyses des sucres libres présents dans la pulpe sont faites par chromatographie gaz-liquide à partir des dérivés triméthyl silylés. Cette méthode, largement utilisée (10), est spécialement indiquée pour la détermination qualitative et quantitative des sucres libres dans les fruits (11-13). Les analyses sont faites, en quatre étapes, pour la pulpe liophilisée ainsi que pour la pulpe séchée au soleil (voir schéma figure 3).

1) Extraction

Elle est effectuée en utilisant le même dispositif que pour les composés phénoliques. Ici, nous n'utilisons que l'éthanol à 80 % comme solvant d'extraction. La ligroïne (3 x 10 ml) est utilisée pour extraire les lipides qui peuvent gêner l'analyse.

2) Purification

Elle est effectuée sur une partie de l'extrait (5 ml) et de la même manière que pour les composés phénoliques. Le polyclar retient les acides et pigments phénoliques qui peuvent réagir par la suite avec le réactif de silylation.

3) Dérivatisation

La formation des dérivés silylés est faite sur un aliquot de l'extrait purifié (2 ml), lequel est évaporé à sec par un courant d'azote dans un mini vial de réaction. Le réactif de silylation triméthylsilylimidazol Tsim (Supelco) présente l'avantage de tolérer de petites quantités d'eau dans le milieu réactionnel. 300 µl de ce réactif sont ajoutés dans le mini-vial de réaction et gardés pendant 30 minutes sous agitation, à 70°C.

4. DETERMINATION PAR CHROMATOGRAPHIE GAZ-LIQUIDE

Les analyses sont effectuées avec un chromatographe Perkin-Elmer 900 équipé d'une colonne en verre (L=4 m, ϕ i=2 mm) rempli de silicone SE-52 5% sur gas chrom Q 80/100 Mesh et d'un intégrateur Hewlett Packard 3380 A.

Conditions d'analyse:

température de l'injecteur 190°C
gas vecteur N₂, 40 ml/min
T_i = 160°C, Isotherme 12 min.
programme: 3°C/min.
T_F = 265°C

L'identification des sucres est faite par comparaison des temps de rétention avec ceux de témoins purs (Supelco). (Figure 4)

Pour l'analyse quantitative, nous utilisons le rhamnose comme étalon interne.

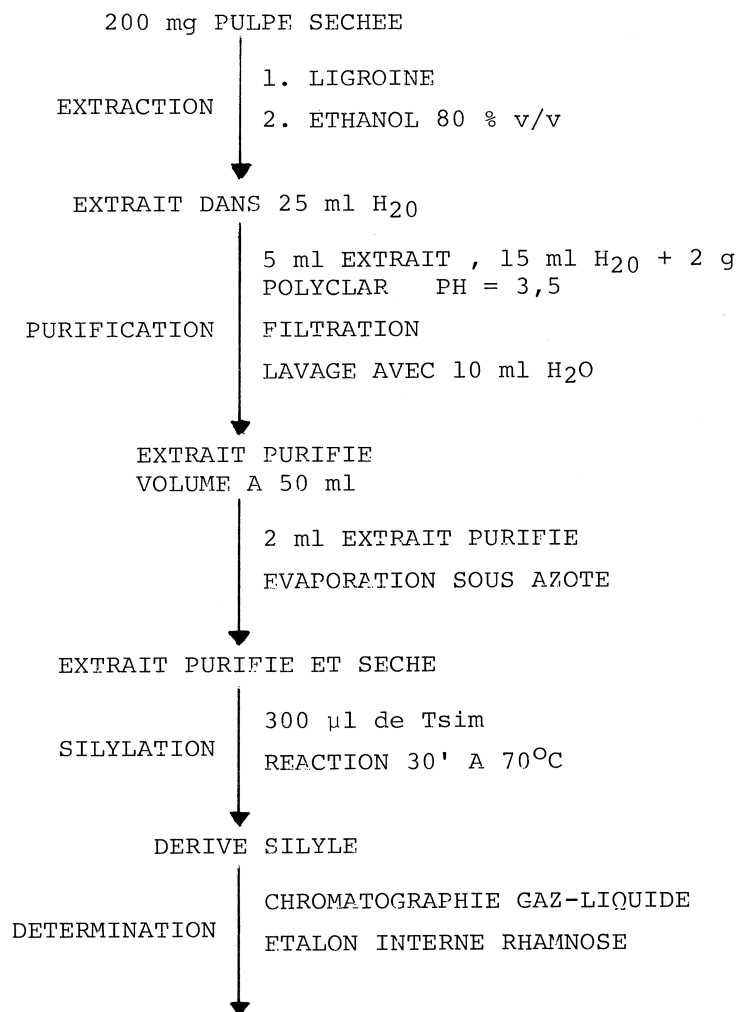

Figure 3. Schéma d'analyse de sucres libres dans la pulpe de café

RESULTATS ET DISCUSSIONS

L'analyse des résultats, sur la teneur en phénols dans la pulpe de café lyophilisée et séchée au soleil (Tableau I), permet de constater l'absence de tannins dans la pulpe fraîche. La formation de tannins commence peu d'heures après la récolte et est accélérée par la présence d'eau et par la chaleur.

La différence en teneur des phénols totaux, entre la pulpe lyophilisée (6,29 mg/100 mg) et la pulpe séchée au soleil (6,62 mg/100 mg), pourrait s'expliquer par une hydrolyse des glycosides, pendant le séchage, avec libération des groupes phénoliques engagés dans des liaisons esters ou etheroxydes.

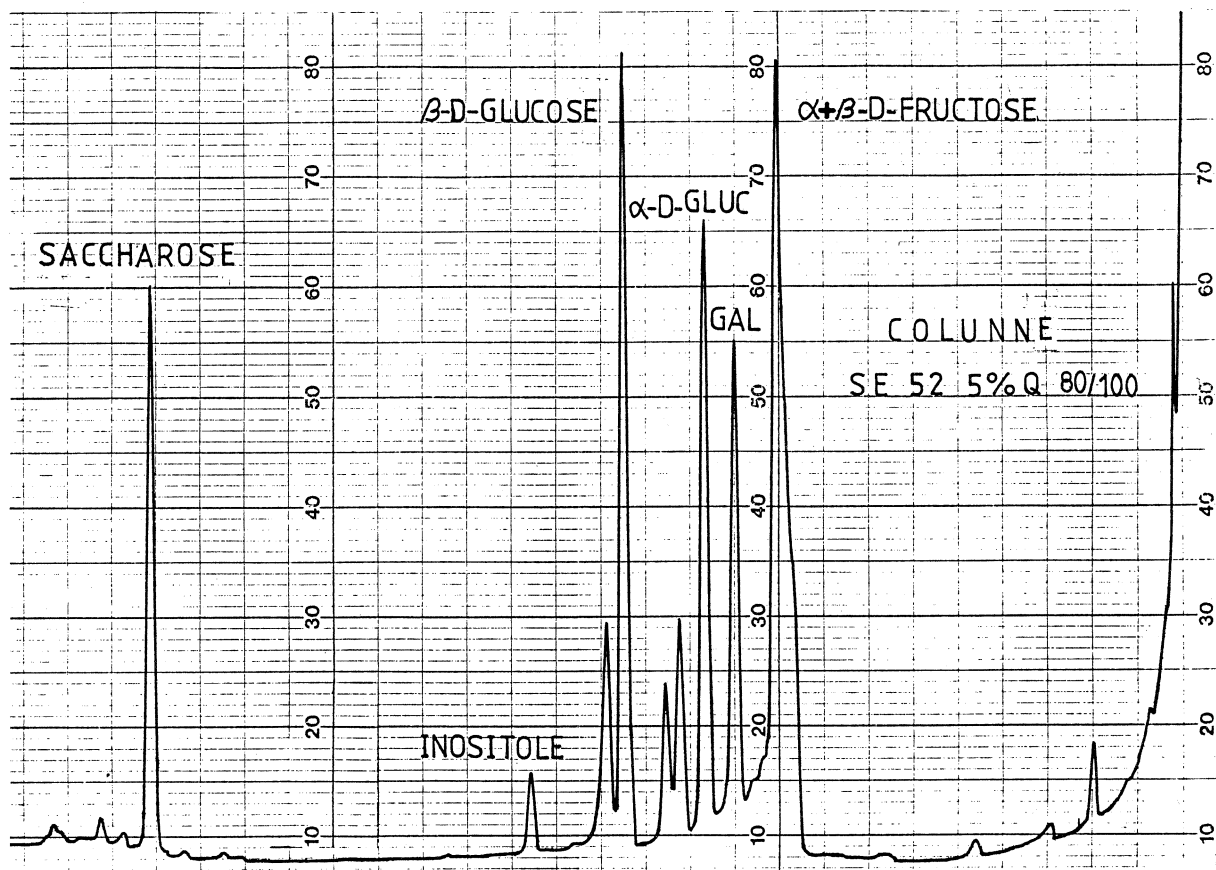

Figure 4. - Chromatogramme des sucres de la pulpe de café

On observe, aussi pendant le séchage au soleil, la formation de 2,07 % de tannins. 25 % de ces derniers sont des tannins hydrolysables et le reste des tannins condensés.

Ces résultats nous permettent de penser que la formation de tannins dans la pulpe de café se fait principalement par une réaction de polymérisation (par condensation) de molécules de type catéchine et leucoanthocyanidines, lesquelles sont les constituantes des tannins condensés. Cette réaction de polymérisation explique la diminution des flavonoïdes de 4,01 % dans la pulpe lyophilisée à 2,83 % dans la pulpe séchée au soleil. De même, la formation de tannins hydrolysables explique la baisse en teneur des phénols simples de 2,28 % (pulpe lyophilisée) à 1,72 % (pulpe séchée au soleil) bien que les acides phénoliques ou leur dérivés soient les constituantes des tannins hydrolysables.

Parmi les sucres libres de la pulpe de café, nous avons identifié $\alpha + \beta$ -D-fructose, $\alpha + \beta$ -D-glucose, D-galactose, saccharose et petites quantités de inositol (figure 4).

L'accroissement de 4 % en teneur totale des sucres libres entre la pulpe lyophilisée et la pulpe séchée au soleil pourrait s'expliquer par hydrolyse de glycosides et polysaccharides pendant le séchage (tableau II).

Le D-fructose (anomeres $\alpha + \beta$) constitue approximativement le 50 % des sucres libres et cette quantité augmente pendant le séchage. Le deuxième sucre important est le D-glucose (anomeres $\alpha + \beta$) qui représente le 30 % du total. Le 20 % qui reste est constitué par la saccharose et la galactose. La quantité de saccharose est diminuée de moitié pendant le séchage au soleil. Le contenu d'inositol est négligeable.

Tableau I: CONTENU PHENOLIQUE DE LA PULPE DE CAFE

TYPES DE SECHAGE	PHENOLS TOTAUX	FRACTIONS NON TANNINS			FRACTIONS TANNINS		
		PHENOLS SIMPLES	FLAVONOIDES	TOTAUX	CONDENSES	HYDROLYSABLES	TOTAUX
LYOPHILISEE	6.29	2.28	4.01	6.29	0.00	0.00	0.00
SECHEE AU SOLEIL	6.62	1.72	2.83	4.55	1.64	0.43	2.07

LES RESULTATS SONT EXPRIMES EN MG D'ACIDE GALLIQUE POUR 100 MG DE PULPE SECHE.
CHAQUE VALEUR EST LA MOYENNE DE TROIS DETERMINATIONS.

Tableau II: CONTENU DE SUCRES DANS LA PULPE DE CAFE

SUCRES	LIOPHILISEE		SECHEE AU SOLEIL	
	MG/100 MG	% DU TOTAL	MG/100 MG	% DU TOTAL
$\alpha + \beta$ -D-FRUCTOSE	9.92	43.8	15.20	57.1
D-GALACTOSE	2.40	10.6	1.88	7.0
α -D-GLUCOSE	3.42	15.1	4.52	17.0
β -D-GLUCOSE	3.42	15.1	3.11	11.7
INOSITOL	0.28	1.2	0.10	0.4
SACCHAROSE	3.21	14.2	1.83	6.8
TOTAL	22.65		26.64	

CHAQUE VALEUR EST LA MOYENNE DE TROIS DETERMINATIONS.

CONCLUSIONS

L'application des méthodes analytiques employées dans ce travail devrait permettre de suivre l'évolution quantitative des différents groupes phénoliques et des sucres libres, pendant les traitements technologiques de la pulpe de café en vue de son utilisation.

BIBLIOGRAPHIE

1. Zuluaga, J. , Bonilla C., Quijano M., Contribucion al estudio y utilizacion de la pulpa de cafe. 7ème Colloque International sur la chimie des cafés. Hambourg, juin 1975.
2. Federación nacional de cafeteros de Colombia., Boletin de información estadística sobre café, No 48-1978.
3. Molina M., De La Fuente G., Batten M., Bressani R., Decaffeination. A process to detoxify coffee pulp. J. Agr. Food Chem. Vol. 22, No 6, p. 1055 (1974).
4. Primera reunión internacional sobre la utilización de subproductos del café en la alimentación animal y otras aplicaciones agricolas e industriales. Informe Final, 11-14 de junio de 1974. Turrialba, Costa Rica.
5. Marigo G., sur une méthode de fractionnement et d'estimation des composés phénoliques chez les végétaux. Analisis., Vol. 2, No 2, p.106 (février 1973).
6. Alibert G., Marigo G., Boudet A., Recherches sur la biosynthèse des composés aromatiques chez les végétaux supérieurs. Identification des acides phénoliques de *Quercus pedunculata* Ehrh. *Physiol. Veg.*, 7 (1), 57-68 (1969).
7. Smith I., Chromatographic and electrophoresis techniques. Interscience Publishers Inc. New York, Vol. 1, p. 324 (1960).
8. Boudet A., Gadal P., sur l'inhibition des enzymes par les tannins des feuilles de *Quercus Sessilis* Ehrh. Isolement des tannins. *Comptes rendus*, 260, 4057, 1965.
9. Kramling T., Singleton V., An estimate of the nonflavonoid phenols in Wines. *Am. J. Enol. Viticult.*, 20, 86, 1969.
10. Davison P., Young R., Gas chromatography of carbohydrates. The quantitative determination of the free sugars of plants as their trimethylsilyl ethers. *J. Chromatog.*, 41 (1969) 12-21.
11. Fitelson J., Detection of adulteration in fruit juices by qualitative determination of carbohydrates by gas-liquid chromatography. *Journal of the AOAC* Vol. 53, No 6, 1193, 1970.
12. Kline D., Fernandez-Flores E., Johnson A., Quantitative Determination of sugars in fruits by GLC separation of TMS derivatives. *Journal of the AOAC* Vol. 53, No. 6, 1198, 1970.
13. Heatherbell D., Rapid concurrent analysis of fruit sugars and acids by gas-liquid chromatography. *J. Sci. Fd Agric.* 25, 1095-1107, 1974.

REMERCIEMENTS

Nous remercions tous ceux qui ont aidé à la réalisation de ce travail, en particulier la Federación Nacional de Cafeteros de Colombia (Laboratoire de recherches LiQC, à Bogota, Centre National de recherches sur le café CENICAFE et Usine de café lyophilisé à Chinchina) et Monsieur Claude Saturnin, Institut de Chimie, à Neuchâtel.

ÉVOLUTION D'UN CAFÉ ARABICA TORRÉFIÉ STOCKÉ DANS QUATRE EMBALLAGES MODÈLES

Analyses sensorielles — Evolution de la fraction volatile Comparaison par rapport à un témoin Limite d'utilisation optimale

E. CROS, G. FOURNY, B. GUYOT, M. ROULY, J.-C. VINCENT

Laboratoires de Chimie-Technologie de l'IFCC,

B.P. 5035, 34032 Montpellier cedex

INTRODUCTION

Le conditionnement du café après torréfaction résulte de plusieurs choix successifs guidés par les considérations suivantes :

- variété du café
- présentation (grain, moulu)
- distribution (circuit commercial)
- conservation
- rendement et coût

La nature de l'emballage devrait répondre ainsi à la conservation de la qualité optimale du café jusqu'à consommation.

La réglementation française (1) prévoit de définir "la date limite d'utilisation optimale" des denrées alimentaires préemballées autres qu'altérables. De plus, un projet de Directive de la Communauté Economique Européenne du 9 octobre 1978, (2) prévoit de définir la date de durabilité minimale des denrées alimentaires, c'est-à-dire la date jusqu'à laquelle le café conserve ses propriétés spécifiques identiques à celles du produit frais.

Nous avons donc au cours de ce travail tenté de définir cette durée optimale de conservation pour un café ARABICA Colombie conditionné dans quatre emballages d'étanchéité croissante.

Nous présentons ici une partie des résultats obtenus au cours du stockage (3) de 40 semaines de nos échantillons.

- Dans un premier temps, nous définissons un témoin représentant le café après torréfaction.

- Puis nous indiquons les résultats obtenus à la dégustation entre ce témoin et nos échantillons.
- Nous présentons ensuite l'évolution de profil chromatographique de la fraction volatile du grain.
- Nous indiquons pour finir qu'il existe une relation entre l'évaluation analytique des fractions volatiles et la perception organoleptique du caractère aromatique des boissons correspondantes.

I - METHODES ANALYTIQUES

I-1- Dégustation

Les dégustations de l'étude de stockage sont conduites selon la méthode du test triangulaire.

Les dégustateurs répondent obligatoirement aux questions :

- 1) - Quel est l'échantillon unique
- 2) - Quel (s) est (sont) l' (es) échantillon (s) le (s) plus aromatique (s)

A la première question, nous fixons un seuil d'acceptation $\alpha = 0,05$ ($P \geq 95\%$). De plus, nous ne prenons en compte qu'une série de points significatifs successifs; ceci permet de dégager l'effet de vieillissement dû au stockage et non pas de caractériser des défauts dus à l'emballage ou au grain lui-même.

La question 2) est analysée comme un test par paire ($\alpha = 0,10$) pour les réponses exactes à la première question.

I-2- Espace de tête

La méthode utilisée (4) consiste en une préconcentration de la fraction volatile sur un polymère hydrophobe (TENAX) suivi d'une analyse chromatographique (C.P.G.).

Les chromatogrammes ont le profil indiqué Fig. 1

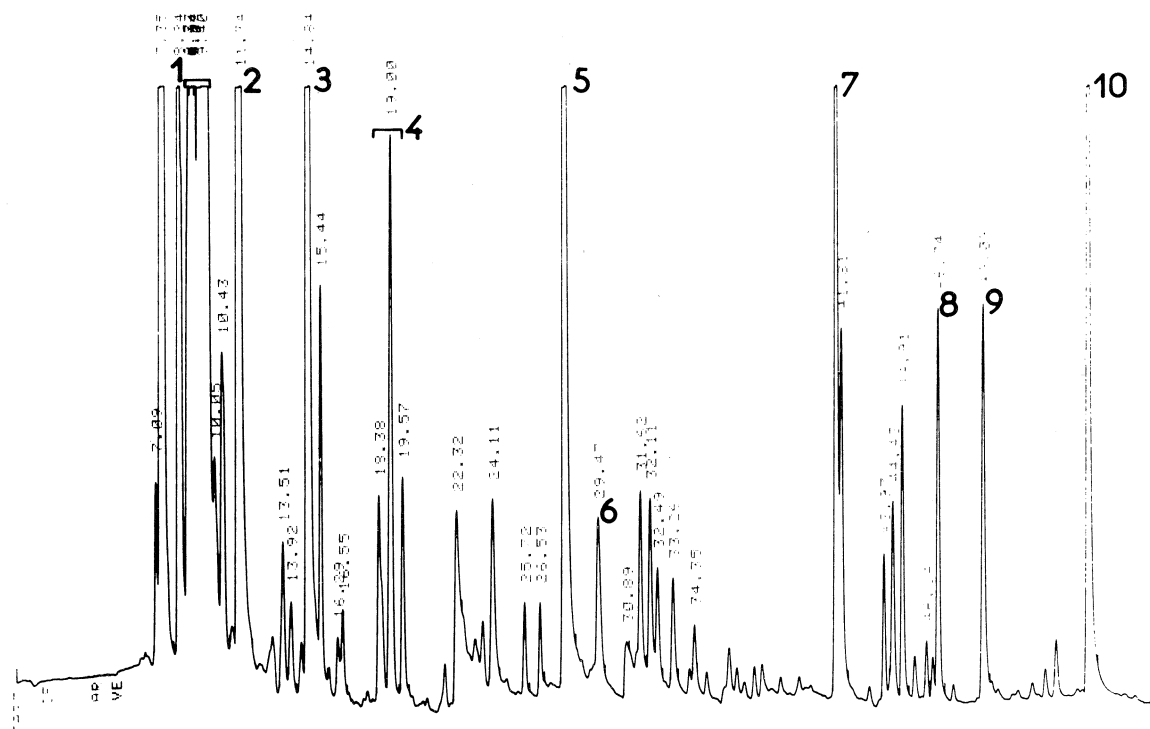

Nous étudions la variation de l'aire de 10 composés ou groupes de composés et afin de simplifier l'étude du phénomène, nous avons groupé ces 10 composés en fonction de leur rétention.

- F.I : pics 1, 2, 3 (dérivés aldéhydes - cétones)
- F.II : pics 4, 5, 6 (composés azotés)
- F.III : pics 7, 8, 9, 10 (dérivés furanniques)

II - CHOIX DE L'ECHANTILLON

L'analyse des espaces de tête nous a conduits dans le choix de l'échantillon retenu pour l'étude de stockage. En effet, plusieurs études conduites antérieurement nous avaient permis de constater qu'un café ROBUSTA présentait au stockage une meilleure stabilité qu'un café ARABICA.

Par exemple, l'analyse de la fraction volatile (figure 2) d'un ARABICA et d'un ROBUSTA conditionnés sous vide dans des emballages identiques montre une décroissance plus importante pour l'échantillon ARABICA. Des résultats analogues sont obtenus pour un conditionnement non étanche.

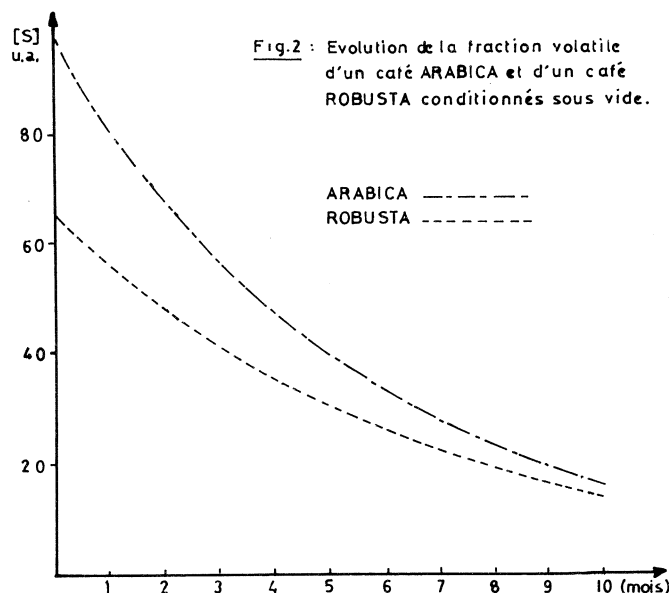

Afin de mieux caractériser l'évolution de nos échantillons, nous avons donc choisi d'étudier le stockage d'un échantillon ARABICA Colombie.

III - CHOIX DES MATERIAUX D'EMBALLAGES

Nous voulons déterminer les dates extrêmes d'utilisation optimale de notre échantillon, c'est-à-dire les dates correspondant d'une part à l'absence d'emballage et d'autre part à l'emballage le plus étanche.

Le choix des emballages suivants :

- Vrac : récipient en verre ouvert à l'air libre.
 - Emballage normal simulé (E.N.S.) : conditionnement dans un complexe métallisé
 - Emballage sous vide (E.S.V.) : dégazage 4 jours en S.A.V. puis conditionnement sous vide dans le même complexe métallisé que pour E.N.S.
 - Sac à valves (5)(S.A.V.) conditionné sous vide dans une pochette (triplex aluminium) muni d'une valve unidirectionnelle.
- permet de dégager :

- l'influence de la conservation sous vide (E.N.S./E.S.V.)
- l'influence du matériau pour 2 emballages étanches (E.S.V./S.A.V.)
- les dates extrêmes d'utilisation optimale (V./S.A.V.)

IV - CHOIX DU TEMOIN

Afin d'évaluer l'évolution de nos échantillons par rapport à un café fraîchement torréfié, il était d'abord nécessaire de définir un témoin représentant ce café frais.

Nous avons choisi de surgeler (-28°C) notre échantillon ARABICA conditionné en S.A.V. 7 heures après torréfaction.

Remarques : si nous surgelons notre échantillon 1 h 30 après torréfaction nous obtenons à la dégustation les résultats indiqués tableau I

Tab. 1 Différences significatives entre échantillon et référence

t	4h30	7 h	24 h	31 h	48 h	56 h	5 j	6 j	7 j	8 j
Dif E/R	-	-	S	S	S	S	S	-	S	S

s : significatif ($P \geq 95\%$)

R : échantillon S.A.V. surgelé 1 h 30 après torréfaction

E : échantillon S.A.V. stocké

Nous constatons que les échantillons E et R sont jugés significativement différents un jour après torréfaction; ceci confirme que le café grain évolue dans les heures qui suivent la torréfaction, et implique qu'il n'est pas possible à l'industriel, de fournir au consommateur un produit dont les qualités sont identiques à celles du café fraîchement torréfié.

Notre témoin (surgelé 7 heures après torréfaction) n'est pas jugé significativement différent de R, il peut être également considéré comme représentatif d'une journée de production.

V - RESULTATS

V-1- Dégustation

Les dégustations sont effectuées toutes les semaines pour l'échantillon V. et tous les 15 jours pour les trois autres échantillons.

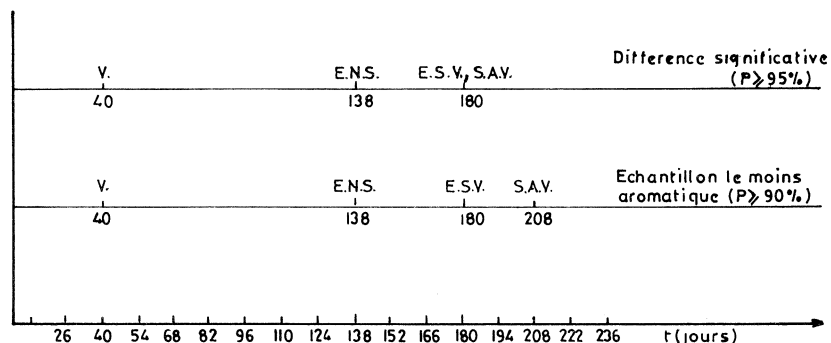

Fig.3: Analyse sensorielle: comparaison échantillon/témoin

La figure 3 indique les dates à partir desquelles les échantillons sont jugés différents du témoin.

Nous constatons que :

a- les différences significatives entre le témoin et les quatre emballages sont perçues entre 40 et 180 jours soit entre la 6^e et la 26^e semaines. La durée optimum de conservation pour notre café 100 % ARABICA Colombie est donc comprise entre 6 et 26 semaines ; tous les emballages de type industriel se situent théoriquement à l'intérieur de cet intervalle de temps, de par le choix de nos emballages modèles.

b- les boissons sont jugées moins aromatiques que le témoin en fonction de l'étanchéité des emballages.

c- la présence d'un emballage (E.N.S./V) retarde d'une façon importante la perception des différences par rapport au témoin.

V-2- Analyse de l'espace de tête

Nous avons montré que toutes les fractions volatiles de nos échantillons suivent une courbe de décroissance exponentielle que nous avons calculée, d'équation générale:

$$y = ae^{-bt} + c$$

La figure 4 indique l'évolution des aires des différentes fractions en fonction du temps.

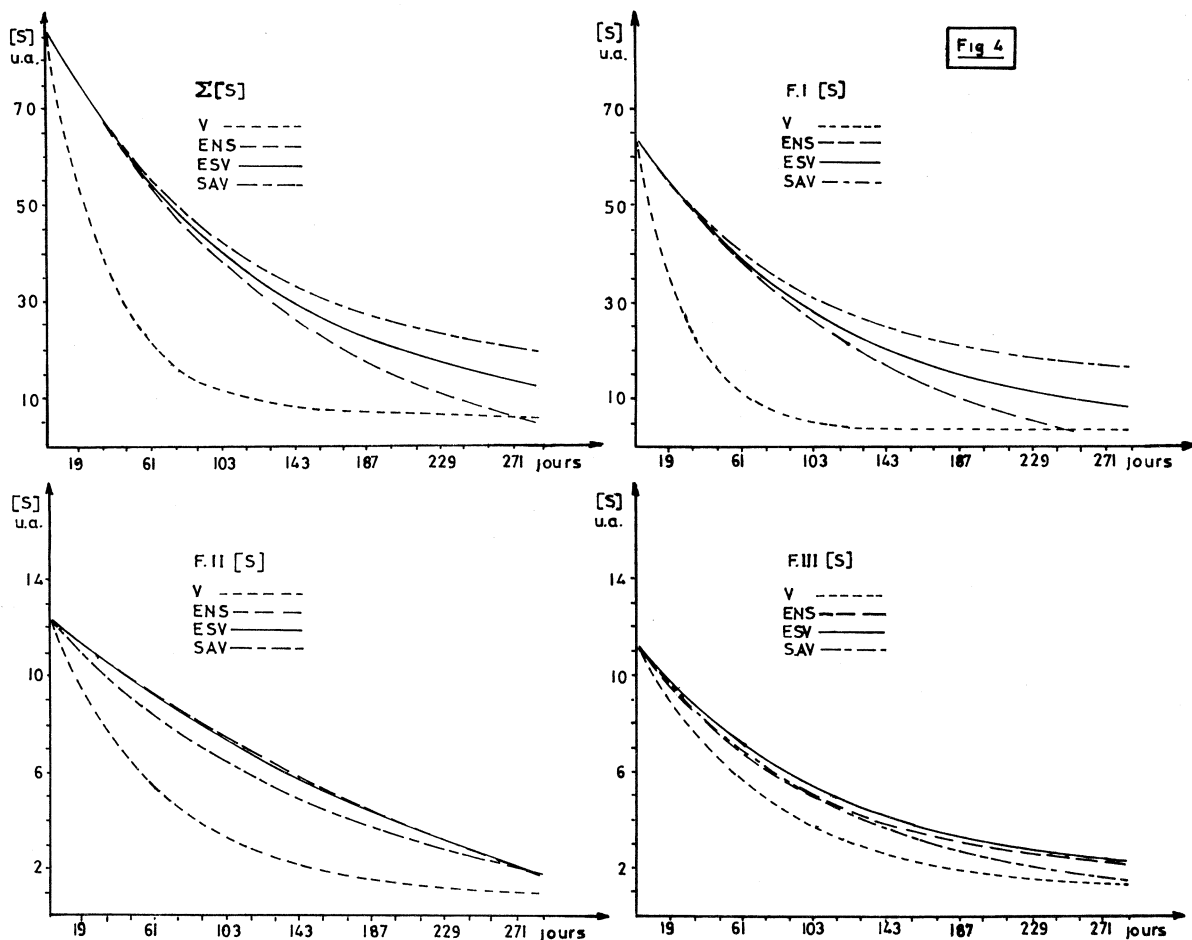

Nous constatons une bonne similitude entre les 3 emballages E.N.S., E.S.V. et S.A.V. pendant 2 à 3 mois. L'évolution de l'aire de la fraction I est une bonne image de la variation globale des 4 emballages.

La figure 5 indique l'évolution des % relatifs de la fraction I pour les 4 conditionnements.

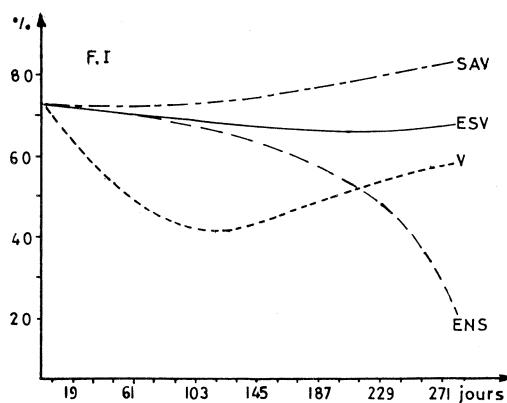

Fig 5

Nous constatons une similitude de comportement entre les 3 emballages E.N.S., E.S.V., et S.A.V. pendant 2 mois, lesquels se différencient ensuite nettement au cours du stockage.

S.A.V. présente une meilleure rétention des composés les plus volatiles.

VI - RELATION DEGUSTATION - ESPACES DE TETE

Les compositions calculées des fractions volatiles aux temps de stockage où les échantillons sont jugés moins aromatiques que le témoin sont indiquées dans le tableau II.

r(t)	40	138	180	206
V I	19.0	3.5	3.2	3.2
II	7.1	2.3	1.6	1.4
III	7.1	2.6	1.9	1.6
ΣS	32.5	8.0	6.7	6.5
ENS I	46.0	18.3	11.2	7.5
II	10.2	6.1	4.6	3.8
III	8.2	4.0	3.2	2.8
ΣS	64.5	28.5	19.0	14.2
ESV I	46.5	21.2	15.7	13.0
II	10.2	6.0	4.5	3.6
III	8.4	4.3	3.5	3.0
ΣS	65.0	31.5	23.5	19.5
SAV I	47.0	25.5	21.3	19.5
II	9.6	5.1	3.9	3.3
III	8.3	3.8	2.8	2.3
ΣS	65.0	34.5	28.0	25.0

Tab. II

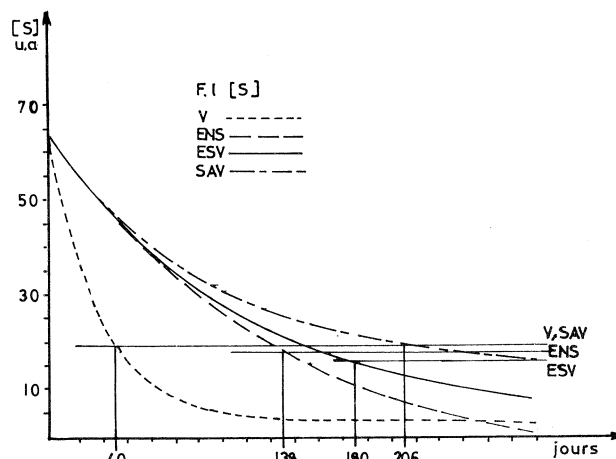

Fig 6

Nous constatons que les compositions de V (40 j), E.N.S. (138 j) E.S.V. (180 j) et S.A.V. (208 j) sont très voisines. Ces résultats sont explicités dans la figure 6 pour la fraction I.

L'évaluation des fractions volatiles des échantillons analysés par notre méthode est en accord avec les résultats de l'analyse sensorielle.

Il semble exister un seuil de perception du caractère aromatique correspondant à un café fraîchement torréfié ayant perdu environ 60 à 70 % de sa fraction volatile.

CONCLUSIONS

Nous avons examiné, au cours de ce travail, le comportement d'un ARABICA Colombie conditionné dans quatre emballages modèles V, E.N.S. , E.S.V. , S.A.V. , au cours d'un stockage de 40 semaines.

Les résultats obtenus à la dégustation indiquent que :

1) La définition d'une durée optimale de conservation est fonction du témoin utilisé et que pour notre témoin (surgelé 7 heures après torréfaction) cette durée est comprise entre 6 et 26 semaines.

2) La conservation en emballages étanches favorise la rétention du caractère aromatique de la boisson.

3) La présence d'un "emballage vrai" (E.N.S./S.V.) améliore notablement la conservation de l'échantillon.

Les résultats analytiques indiquent que :

1) La composition de la fraction volatile est une fonction du temps de stockage, et que tous les échantillons suivent une courbe de décroissance d'équation générale $y = ae^{-bt} + c$

2) La date limite d'utilisation optimale n'a plus de sens dans la mesure où, quel que soit l'emballage, tous les échantillons évoluent immédiatement après torréfaction.

3) Les échantillons E.N.S., E.S.V., et S.A.V. sont sensiblement identiques pendant environ 2 mois de stockage.

4) Il existe une relation entre l'évaluation analytique des fractions volatiles des échantillons et la perception organoleptique du caractère aromatique des boissons correspondantes.

Notre étude de stockage a été effectuée sur un échantillon d'ARABICA Colombie, à une torréfaction donnée. Or, nous savons que la qualité du lot de café vert ainsi que la torréfaction ont une influence déterminante sur la qualité du produit fini. Les résultats de notre étude ne sont donc en l'état, applicables qu'à notre échantillon.

BIBLIOGRAPHIE

- 1 - Arrêté du 22 août 1979 - JORF septembre 1979
- 2 - Circulaire du 19 août 1970
- 3 - Café - Cacao - Thé - sous presse -
- 4 - E. CROS ; B. GUYOT ; J-C- VINCENT
Café, Cacao, Thé, 1979, 3, p. 193-202
- 5 - U. HAEVECKER
Chem. Mikrobiol. Technol. Lebensm. 1979, 6 , 2, p. 33-35

POSSIBLE INTERACTION OF COFFEE CONSUMPTION WITH CARDIOVASCULAR DISTURBANCES



L. Wilhelmsen

L. WILHELMSSEN, MD, Assoc. Prof., G. TIBBLIN, Prof., D. ELMFELDT, MD.,
K. SVÄRDSUDD, MD., H. WEDEL, Ph. D.

The Section for Preventive Cardiology, Departments of Medicine,
Sahlgrenska and Östra Hospital, University of Göteborg, Göteborg, Sweden.

Adress for correspondence :

Lars Wilhelmsen MD, Physician in chief, Östra Hospital, S-416 85 Göteborg, Sweden

Caffeine is a known cardiac and cerebral stimulant. Thus, coffee has been labelled a pro-arrhythmic agent and by implication could be a factor in sudden death due to fatal cardiac arrhythmia. Coffee can cause a slight and transient rise in blood pressure and pulse rate, and effects on blood lipids have also been suggested. Repeated stimulation by coffee could conceivably have adverse effects on the cardiovascular system. The short term effects of coffee such as tachycardia, palpitations, heartburn and other symptoms from the upper gastrointestinal tract are usually voluntarily avoided by discontinuation of drinking coffee. Thus, these problems are relatively easy to monitor and do not generally cause serious medical problems. If, however, coffee causes long-term effects which are not detected by the drinker himself, these effects would be potentially more dangerous.

Even a minor increase of the risk for disease may have important implications for health because coffee drinking is such a common habit in some countries. Thus, if there is a big number of moderate coffee drinkers they may suffer a considerable number of health problems because their risk for disease has to be multiplied by the number of individuals at risk according to the "population attributable risk" concept. This concept has attracted increasing interest during recent years with respect to for example elevated blood pressure (Wilhelmsen, 1979).

The most common heart diseases have to do with atherosclerosis of the coronary arteries - that is deposition of lipids into the walls of these vessels with following disturbances of the blood flow which in turn can lead to angina pectoris (AP), myocardial infarction (MI) or sudden coronary death (SD) - these manifestations are often put under the heading coronary heart disease (CHD). Thus, these diseases are usually believed to belong to the same family of diseases, but the pathogenesis may be different. Therefore, it is advisable at least to discuss AP separately from MI and SD.

The classical epidemiological approach in looking for risk factors for disease has been to study a population prospectively. That is to examine a series of personal characteristics at baseline, follow morbidity and

mortality and then look for associations between baseline characteristics and disease. This study design deserves long-term follow-up of a considerable number of people. A case-control methodology in a cross-sectional study may be used prior to the prospective study to get some hints on important associations; already sick people are compared with healthy controls in this design. However, this method is afflicted with several sources of bias: only surviving patients can be studied, characteristics may change with the disease, or answers to questions may be influenced by the disease experience, and the controls may not be representative for the background population. Thus, any finding in a case-control study has to be considered with caution, and should ideally be confirmed in a prospective study.

Coffee and coronary heart disease in previous studies

The first indication from epidemiological studies that caffeine might cause heart disease came in a report by Paul et al 1963. During a prospective study of 1162 employees in Chicago, it was found that those 54 who developed AP, MI or SD, drank on average 4.2 cups of coffee a day, whereas the remainder drank only 3.5 cups a day ($p < 0.025$). Subsequently, Paul et al (1968) demonstrated that most of the apparent association between CHD and coffee drinking could be explained by the association between coffee drinking and smoking, with a suggestion in multivariate analysis that high coffee drinking even offered some protection against the harmful effects of excessive smoking. In a different analysis of more cases from the same study (i.e., 157 out of 1718), Paul (1968) noted a tendency to a U-shaped relationship between coffee consumption and incidence of CHD, whereby both low and high, but no moderate, consumption was associated with AP, MI and SD.

In the year after Paul's first report, Yudkin and Roddy (1964) provided data that appeared to implicate excessive caffeinebeverage consumption in MI among the English population. Tea and coffee were not distinguished in this report. In a later report on a different series of patients, Yudkin and Morland (1967) noted that their 40 MI patients consumed an average of 7.7 cups of tea and 0.8 cups of coffee a day, whereas the 58 control patients consumed 5.6 cups of tea and 1.4 cups of coffee each day. Thus, these cross-sectional data appear to implicate tea and not coffee consumption in MI.

Little et al (1965), reported no significant difference in tea or coffee consumption between surviving MI patients and controls. Coffee drinking and not tea drinking was later found to be associated with serum lipid elevation in heart patients but not in controls and the authors discussed in a later paper (Little et al 1966) that coffee contains a substance that may be associated with increased susceptibility to CHD.

In the Boston Collaborative Drug Surveillance Program (1972) the data from hospital patients were analyzed for an association between coffee and tea drinking and MI. Their results indicated that MI patients drank significantly more coffee, but not tea, than matched controls. No association was found with respect to other forms of heart disease. Cigarette smoking, although strongly correlated with coffee drinking, was ruled out by these authors as a factor in MI. In fact, coffee drinking appeared to increase the risk of MI less for heavy smokers than for non-smokers. A subsequent study by the same group, also retrospective, corroborated the difference between coffee and tea drinking (Jick et al 1973). In both studies, the MI risk associated with drinking six or more cups of coffee a day was estimated to be more than twice that associated with drinking no coffee at all. The authors concluded however, that no causal relationship between coffee drinking and MI could be presumed in the absence of appropriate data from prospective studies. The study used hospitalized patients for the analysis - both cases and controls. Thus, deceased patients were excluded, and serious criticism can be raised against their controls regarding representativity.

Prospective data from the Kaiser-Permanente Study was published by Klatsky et al (1973). They compared 464 persons who subsequently suffered a first MI, 464 controls who were matched for CHD risk indicators, and 464 controls who were matched for age, sex, skin color, and examination date, but not for CHD

risk. Close to 20% of each group reported drinking more than six cups of coffee a day, with none of the percentage being significantly different from each other or from the percentage of 110,000 unselected examinees that reported drinking more than six cups per day. Again, a curious relationship with cigarette smoking was found. Compared with risk controls who were smokers, infarct victims who were smokers were less likely to have reported drinking more than six cups of coffee a day (28.9% vs 36.8%), whereas the proportion of non-smokers drinking more than six cups a day was the same for victims and risk controls (10.8%). Thus, smoking and coffee consumption appeared to be less well correlated among MI victims than among risk controls, suggesting indirectly that those who used both habits to an excess were less likely to suffer an MI.

A prospective analysis of the Framingham files revealed no association in multivariate analysis between daily coffee consumption at the fourth biennial examination and subsequent incidence of various kinds of heart disease (Kannel and Dawber, 1973). Coffee consumption was positively correlated with subsequent incidence of deaths from all causes, and MI, SD and AP, but these associations did not survive correction for amount of cigarette smoking. Heyden et al (1978) did not either find an association either with CHD, cancer or total mortality in their prospective analysis from the Evans County population.

Studies in Göteborg, Sweden.

The per capita consumption of coffee in Sweden is the highest among reporting countries with a wide range from zero to a very high consumption in the population samples studied by us. An on-going prospective study of a random population sample of men in Göteborg, all aged 50 years when entering the study in 1963, has given some results concerning the relationship between coffee consumption and CHD. In this study, age is standardized, several variables are studied prospectively and the follow-up is thorough, including a high autopsy rate (around 90%) of those dying. Univariate and multivariate analysis of risk of CHD has been performed. The results have also been compared with a non-selected series of men of similar age who have survived an MI. An on-going primary preventive trial involving 7,500 initially screened men (in 1970-73) will also give further data on coffee consumption and disease during follow-up.

Population series.

The sample drawn for the study of 50-year-old men (born in 1913), was obtained from the official census in 1963. All 973 men who fulfilled these criteria and were born on dates divisible by three comprised the study sample. Of these, 855 (88%) agreed to be examined. The present prospective analysis is based on a study of those 834 men, who were free of CHD at entry to the study. One physician checked the average number of cups of coffee which the subjects said they consumed each day. The highest value within a reported range was recorded. No analysis of blood caffeine levels was available.

Patients having suffered a myocardial infarction. During the period Jan. 1968 - Dec. 1970, in total 230 men aged 40-57 years (mean age 50) were discharged alive from hospital in Göteborg after a first MI. For 220 of them, a history of coffee consumption prior to the MI was recorded about one week after admission for their MI. The coffee consumption of all men in the previously mentioned population sample was recorded in 1963, but in 1968-1970 for the men with MI. A bias might have been introduced by a time trend in the amount of coffee consumed. Therefore, we compared the coffee consumption of other random population samples of men of the same ages in 1963 and 1974 and found the same distributions. Furthermore, there was no change in consumption between ages 50 and 59 years in the population of men born in 1913. All variables were measured in exactly the same way in the series of MI patients as in the population samples. Thus, several sources of bias have been looked for.

Myocardial infarction (MI) during 15 years follow - up in relation to coffee consumption at age 50. The Study of Men Born in 1913.

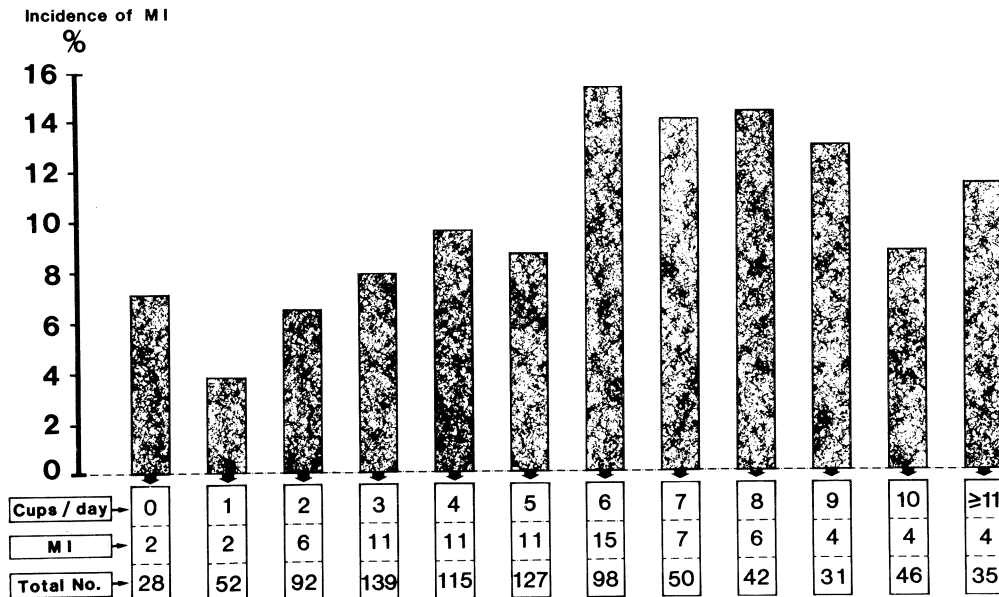

Wilhelmsen, Svärdsudd and Tibblin 1980

Figure 1.

Results - Population series.

The univariate analysis of the relationship between coffee consumption and MI during 15 years' follow-up is shown in Fig. 1. The percentage of cases with MI increased somewhat with increasing coffee consumption, but the trend is not consistent and does not show any statistically significant relationship.

Coffee consumption was significantly associated with two other important risk factors for MI, namely smoking ($r=0.22$) and alcoholic intemperance. The mean (\pm S.D.) coffee consumption of those not registered by the Temperance Board was 4.90 ± 2.79 and of those registered 5.93 ± 3.54 cups a day. There were very weak (non-significant) relationships between coffee consumption and serum cholesterol, serum triglycerides, systolic or diastolic BP, and dyspnea on exertion (Wilhelmsen et al 1977).

In Table 1 we have adopted the grouping of individuals into three groups according to coffee consumption which was used by the Boston group, i.e. no coffee, 1-5 cups a day, 6 cups a day or more (Wilhelmsen et al 1977). A grouping was also made with respect to smoking habits and alcoholic intemperance. Not even with this type of analysis was it possible to show any association between coffee consumption and MI.

In a previous paper it was noted that high serum cholesterol, high BP, smoking, dyspnea on exertion, and registration by the Temperance Board each increased the risk of MI (Wilhelmsen et al 1973). Coffee consumption could not be shown to be significantly related to MI when smoking and registration by the Temperance Board were included in the analysis. When coffee consumption was included, alcoholic intemperance lost its significant association with MI, probably due to the slight relationship between coffee consumption and MI (Wilhelmsen et al 1977).

Table 1. Coffee consumption and incidence of CHD during 12 years in the population sample of men.

Coffee consumption (cups/day)	No. of men		Incidence (%)
	CHD cases	Total	
Total series			
0	2	31	6.5
1-5	29	519	5.6
> 6	29	296	9.8
Present smokers			
0	1	6	16.7
1-5	24	275	8.7
> 6	25	191	13.1
Present smokers registered by Temperance Board			
0	1	5	20.0
1-5	7	94	7.4
> 6	12	77	15.6

MI patients and population series.

When comparing the MI patients and the population series, it was found that the former consumed significantly more coffee (6.5 ± 4.1 cups/day) than the latter (5.1 ± 3.0 cups/day). This was true both when the patients were compared with those men of the population sample who did not have MI (5.1 ± 3.0 cups/day) and with those who later suffered a non-fatal MI (5.5 ± 2.5 cups/day). Thus, the retrospectively reported consumption (in the series of MI patients) was higher than the consumption reported by those who later suffered MI (in the prospective analysis of the population sample). With the aid of the non-parametric multivariate analysis of the combined population sample and the series of MI patients, significant association ($p < 0.05$) was found between coffee consumption and MI. In this analysis, we standardized for the possible confounding variables smoking habits, serum cholesterol, BP and alcoholic intemperance.

Table 2. Relationships between coffee consumption and disease in the Study of Men Born in 1913. p-values in univariate, and multivariate non-linear analyses.

Disease	Univariate Coffee	Multivariate		
		Coffee BP	Coffee Smoke	Coffee BP Smoke Cholest.
MI (N=83) non-fatal and fatal	0.09	0.09	0.42	0.50
Stroke (N=29) non-fatal and fatal	0.08	0.05	0.08	0.13
Cancer mortality (N=35)	0.74	0.70	0.90	0.80
Total mortality (N=125)	0.10	0.08	0.34	0.22

A prospective analysis of coffee consumption in 1963 in relation to the 83 fatal and non-fatal MI cases, 29 cases of fatal or non-fatal stroke, and 125 cases of death (CHD: 50, cancer: 35, and other deaths: 40) has been performed. Table 2 shows the p-values in univariate and multivariate analysis. There was a near significant association with stroke in univariate analysis ($p=0.08$), which became significant when systolic blood pressure was taken into account ($p=0.05$), but became insignificant when also smoking and serum cholesterol was included ($p=0.13$). There was no tendency towards a relationship between coffee and total mortality or cancer mortality but a trend for total mortality, Fig. 2, which disappeared in multivariate analysis.

Total mortality during 15 years follow-up in relation to coffee consumption at age 50. The Study of Men Born in 1913.

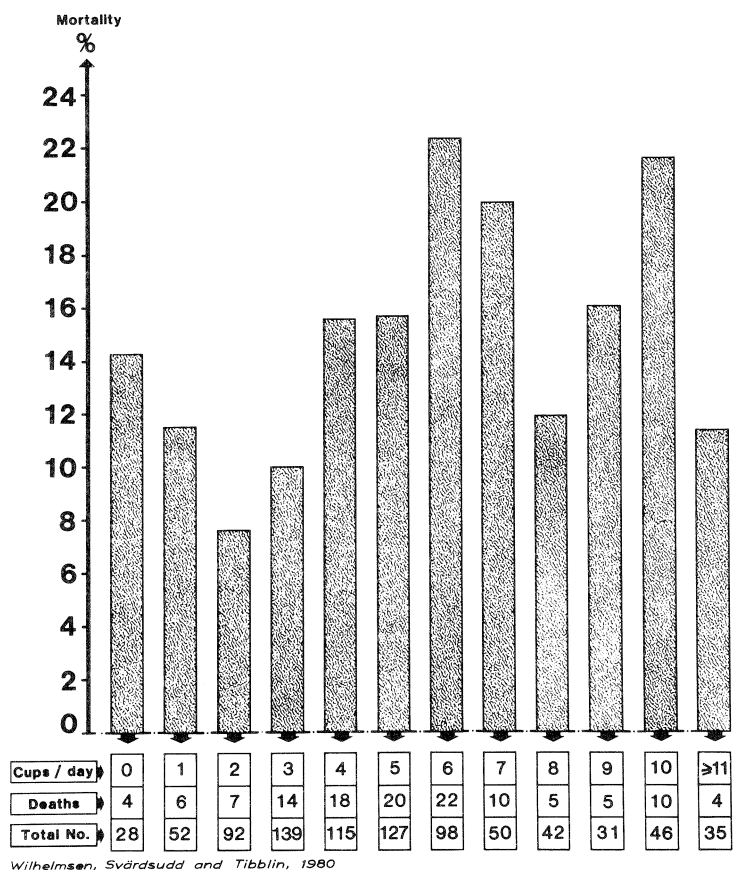

Figure 2.

Discussion

In the present analysis we were not able to find that coffee consumption was a significant risk factor for MI in a random population sample of middle-aged men all aged 50 years at entry with strongly varying coffee consumption, and this in a situation where we could standardize, by a multivariate logistic model, for the effect of other risk factors. The same age greatly facilitates the analysis. The number of those who have suffered disease is not large; but large enough to show significant associations with the most important risk factors for MI which have been found in other prospective studies. In spite of having the highest reported coffee consumption, the official age-specific death rate for MI is low in Sweden compared with, for example, Finland, United Kingdom or USA.

The second part of our study enabled us to perform a comparison very similar to that of the Boston group, namely between surviving MI patients and individuals without MI. Using a random population sample as controls, we could rule out bias due to a possible decrease in coffee consumption because of disease in the controls which cannot be completely excluded in the Boston study, where hospitalized patients were used as controls. We, however, made a disturbing finding, namely, the different consumption values given by the MI patients, when interviewed prospectively compared to retrospectively. A plausible explanation is that the psychological trauma of having had an MI has affected the patients' rating of coffee consumption or, alternatively, that the consumption really did increase during some months (or a few years) before the MI. If the latter explanation is true, some type of physiological and/or psychological change, occurring as a premonitory mechanism before an MI, might be responsible for the change of habits. At present we have no data to corroborate this hypothesis and we know nothing about spontaneous changes in individual coffee consumption in preclinical disease states. In the healthy population the consumption was very stable according to our data. It is possible that coffee has a fairly short-term effect on the risk of MI, and that the increased risk disappears rapidly after a decrease in consumption. To be able to show such a short-term effect in a prospective study, a very large number of cases at risk must be studied with repeated interviews.

The important risk factors tobacco consumption and alcoholic intemperance, were strongly associated with coffee consumption in our study. The latter factor might explain some of the relationships found in other studies. These factors (high coffee, tobacco and alcohol consumption) may be additive in some way. The positive relationship between the three may also indicate some common psychological background mechanism, which could simultaneously increase the risk of MI and increase the use of coffee, tobacco and alcohol.

From a biological point of view, consumption of excessive amounts of cerebral and cardiac stimulants cannot be recommended, but the problem is whether our present knowledge warrants the addition of coffee drinking to the list of dangerous living habits which have to be abandoned. According to the present knowledge we do not consider the case against coffee so strong that a ban on coffee consumption can be scientifically justified. There are, however, indications in the data which call for further surveillance of the problem in bigger studies. Such a study is going on in Göteborg.

References

1. Wilhelmsen L. Salt and hypertension. Introductory lecture at International Society of Hypertension Meeting 1979. Clin Science and Molecular Med. Suppl. 57:455-458, 1979.
2. Paul O, Lepper MH, Phelan WH, Dupertuis GW, MacMillan A, McKean H, Park H. A longitudinal study of coronary heart disease. Circulation 28:20-31, 1963.
3. Paul O, MacMillan A, McKean H, Park H. Sucrose intake and coronary heart-disease. Lancet 2:1049-51, 1968.
4. Paul O. Stimulants and coronaries. Postgrad. Med. 44:196-199, 1968.
5. Yudkin J and Roddy J. Levels of dietary sucrose in patients with occlusive atherosclerotic disease. Lancet 2:6-8, 1964.
6. Yudkin J and Morland J. Sugar intake and myocardial infarction. Am J Clin Nutr 20:503-506, 1967.
7. Little JA, Shanoff HM, Csima A, Redmond SE, Yano R. Diet and serum-lipids in male survivors of myocardial infarction. Lancet I:933-935, 1965.
8. Little JA, Shanoff HM, Csima A, and Yano R. Coffee and serum lipids in coronary heart-disease. Lancet I:732-734, 1966.
9. Boston Collaborative Drug Surveillance Program. Coffee drinking and acute myocardial infarction. Lancet 2:1278-1281, 1972.
10. Jick H, Miettinen OS, Neff RK, Shapiro S, Heinonen OP, Slone D. Coffee and myocardial infarction. N Engl J Med 289:63, 1973.
11. Klatsky AL, Friedman GD, Siegelau AB. Coffee drinking prior to acute myocardial infarction - Results from the Kaiser-Permanente epidemiologic study of myocardial infarction. JAMA 226:540-543, 1973.
12. Kannel WB, Dawber TR: Coffee and coronary disease. N Engl J Med 289:100, 1973.
13. Heyden S, Heyden F, Heiss G, Hames CG: Smoking and coffee consumption in three groups: Cancer deaths, cardiovascular deaths and living controls. A prospective study in Evans County, Georgia. J Chron Dis. 32:673-677, 1979.
14. Wilhelmsen L, Tibblin G, Elmfeldt, D, Wedel H, Werkö L: Coffee consumption and coronary heart disease in middle-aged Swedish men. Acta Med Scand 201:547-552, 1977.
15. Wilhelmsen L, Wedel H, Tibblin G: Multivariate analysis of risk factors for coronary heart disease. Circulation 48:950, 1973.

COFFEE IN HEALTH AND DISEASE

A critical review of the medical literature



S. HEYDEN, M.D., Ph. D.

Professor of Community and Family Medicine

Duke University Medical Center

Box 2914

Durham, North Carolina 27710

INTRODUCTION:

After 15 years involvement in coffee research, I would like to offer a few observations on the presently available scientific information on coffee as it relates to health and disease. It is not the purpose of this presentation to dispute the claims of scientific investigators or science writers who are reporting or commenting on findings of coffee research. But as a physician, I feel a responsibility to seek documentation of any claim made about coffee or caffeine in order to obtain the most accurate data available. The availability of accurate, authoritative information can provide insurance against the spread of erroneous and exaggerated reports which contribute to the accumulation of misinformation about coffee and caffeine.

Coffee and Fibrocystic Breast Disease:

Virtually thousands of physicians who regularly consume the weekly Current Contents may have read the article "Should We Kick the Caffeine Habit?" in the February 18, 1980 issue by the editor, E. Garfield. After the Washington Post and several less important lay publications across the country have informed the frightened women of America to abstain from coffee in order to avoid or eliminate fibrocystic breast disease and its sequellae, the medical profession is kept "abreast" of Dr. Minton's ongoing research by the above Current Content's article. The time has come to place this hypothesis in proper perspective and to re-read the original paper more carefully.

It all started with the publication in July, 1979 in the journal Surgery on the alleged causal association between coffee drinking and the development of fibrocystic disease and its prompt disappearance with abstinence from coffee. This paper was followed by a second article by the same authors (Minton et al) in the September, 1979 issue of the American Journal of Obstetrics and Gynecology. The theory behind this finding, i.e., "methylxanthine consumption is associated with elevated cyclic adenosine monophosphate and cyclic guanosine monophosphate values in fibrocystic disease over those obtained in normal breast tissue" is irrelevant at this point. What is important is the

meager evidence on which the claims are based and the warning expressed in the discussion, "the possibility that methylxanthine consumption is related to the development of malignancy should be considered." What are the facts?

(1) Forty-seven women with fibrocystic disease were advised to stop all methylxanthine consumption. Mean caffeine consumption was 190 mg/day, equivalent to 4 cups/day. Twenty women abstained totally from coffee and thirteen of them experienced complete disappearance of all palpable breast nodules within 1 to 6 months.

(2) The four women in whom the disease did not resolve even with abstention from all methylxanthine-containing liquids, are described "to be below ideal weight and athletically active and to have above-average intelligence." No comment is indicated on this observation since the authors themselves state, "the importance of this observation is not clear."

(3) What remains even more clouded in mystery is the authors' contention that "the extent and location of disease in an individual patient seems to be related to the total of milligrams (of caffeine) consumed in each 24 hour period." They state that the upper outer quadrant of the breast "was most commonly involved" and this is exactly the experience of every breast surgeon.

(4) Smoking slowed or prevented resolution of fibrocystic disease in some patients but no details on numbers or amount of cigarettes are presented.

(5) This finding is followed by a strange sentence: "In most women changing the concentration of methylxanthine exposure permitted resolution of disease, and in a few women it totally reversed their apprehensions concerning bilateral subcutaneous mastectomies and prostheses because their symptoms and signs resolved." Why were such major surgical procedures carried out on patients whose symptoms and signs presumably have disappeared?

(6) "When patients resumed their usual methylxanthine consumption, their disease recurred." No documentation of the disappearance and re-appearance of fibrocystic disease was attempted and one wonders how many women experienced this extremely common occurrence among middle-aged women. In fact, it is this well-known characteristic of fibrocystic disease with its "waxing and waning" which causes concern about the credibility of the reported findings. This problem becomes compounded by the observation: "A few women adjusted their methylxanthine consumption to a level at which the disease was not symptomatic." It is implied that by drinking, e.g., 2 or 3 cups instead of 4 or 5 cups, the disease became controllable. The human desire to relate cause and effect often despises logic and common sense. How can we accept repeatedly vague descriptions as "a few", "some", or "in most" when the total number of patients responding to total abstention from coffee, tea and other methylxanthine-containing beverages was only 13?

(7) The referral to epidemiological findings on the low incidence of breast cancer among Mormon and Seventh Day Adventists women, both sects with abstention from coffee- and tea-drinking, is dangerous since the really important issues, i.e., age at first pregnancy, number of children, breast feeding practices, mode of contraception, etc. were simply disregarded with the sole purpose to fit an untenable hypothesis. This type of argumentation is scientifically wrong and misleading. As Dr. Wells observed by his remarks in the discussion of the paper, it would have been really helpful if this study had been done in a randomized way, with at least a single blind component, where the examining physician was not aware whether a patient had abstained from coffee or not. He also inquired if there is any animal model available where methylxanthine is added to the diet and changes in breast tissue are detected. Minton et al. have conducted such studies for two years in the breast cancer prone C3H-strain of mice and could not detect an increased incidence of malignancies. Not that the animal experiment would be necessarily required for acceptance of the alleged pathophysiology in man, but it would have provided some assurance that this matter might be lending some plausible explanations for the proposed hypothesis. In summary, neither from the animal-experimental, epidemiological nor clinical experience is there any reason to associate coffee consumption and fibrocystic disease.

Coffee and Bladder Cancer:

It was assumed that this issue had been satisfactorily resolved but judging from the recent issue of the American Journal of Epidemiology (110:255, 1979) this question has been all but answered. The authors reported, "a small, not entirely consistent increase in bladder cancer risk with increasing coffee consumption was seen." Reference is made in Table 2 of their article to substantiate the claims made, however, not a single p value reaches significance. The conclusion, as I see it, must read that the relative risk for frequency of coffee drinking (within categories of smoking) in bladder cancer is not significant.

Caffeine and Cancers in the Animal Model:

Nutrition Reviews (April, 1979) reviewed some long-term studies and published a Special Report, resulting from the workshop conducted Nov. 8-10, 1978 in Hawaii under the auspices of the International Life Science Institute. Dr. Mohr found no carcinogenic effect in his review of the toxicology of caffeine. Dr. Palm varied the caffeine intake from 14 to 101 mg. per kg./day in a 2 year rat experiment. None of the experimental regimes appeared to alter the time of appearance or the incidence of primary neoplasms. The number of rats with metastatic tumors was inversely related to coffee consumption. Dr. Takayama who had detected a higher incidence of endocrine tumors in caffeine-treated rats decided to repeat the study since the level of caffeine intake and incidence of tumors were not related. Dr. Ito had some special problems, in that his male mice data were inconclusive because caffeine treated and control groups had a high mortality due to fighting, feeding effects were therefore inconclusive. The female mice did not develop more tumors than water drinking controls over 104 weeks.

Coffee and Ventricular Premature Beats:

The answer to the question of a causal association between regular usage of xanthine-containing beverages and the induction of VPB or exaggeration of pre-existing supraventricular dysrhythmias is by no means clear. There are cardiologists who do not even consider the topic worthwhile of discussion, whereas others warn their patients to limit caffeine-containing beverages or eliminate them altogether. No consensus has been reached even in carefully conducted population studies. The Evans County study compared strong coffee consumers (defined ≥ 5 cups of coffee per day) with low-or-no coffee consumers and found no difference in the prevalence of electrocardiographically documented arrhythmias. This result, of course, would not exclude the possibility that susceptible individuals may indeed develop VPB when exposed to caffeine. The largest study ever undertaken, involving 7,000 men aged 35-57 years and free of any history of heart disease was conducted by Prineas et al. As expected, the prevalence of ventricular premature beats increased with age, in a linear fashion from 2.3% at age 35-39, to 2.5% at age 40-44, 3.5% at age 45-49, 5.1% at age 50-54 and 6.6% in the oldest age group 55-57 years. This overriding importance of age on the development of VPB has been described by other investigators and apparently remains the strongest risk factor, in this particular study statistically highly significant ($p < .001$) when men below age 39 were compared with men beyond age 55 years. The association with age remains statistically significant after multiple regression analysis, adjusting for cholesterol, blood pressure, smoking, alcohol, tea and coffee consumption. A surprise was provided in the results from the smoking history in relation to VPB, since VPB was found in 3.6% of nonsmokers. Smoking only 1-15 cigarettes was associated with only 3.2% VPB, and up to 1 pack per day with 3.6% VPB. Among heavy smokers (< 30 cigarettes/day) and very heavy smokers (≥ 30 cigarettes/day), the percentage of persons with VPB increased to 4.1 and 4.4, respectively. Therefore, the trend toward higher rates of VPB by smoking intensity was demonstrated, but not found to be statistically significant, an observation recently confirmed by Regan (1979). The data revealed a significant and positive association between tea ($p < .001$) and coffee drinking ($p < .005$) and the presence of VPB. The association remains significant after adjusting for age and known coronary risk factors. It is not possible from these data to separate a threshold effect of xanthine-containing beverages. What is the biological significance of this data?

(1) It is important to realize that in this unselected sample of the male population, complete abstinence from tea or coffee was associated with slightly higher prevalence rates of VPB than in light tea or coffee drinkers (3.1% in non-coffee drinkers vs. 2.3% in low-coffee consumers of 1-2 cups/day vs. 3.2% in coffee drinkers of 7-8 cups/day).

(2) A heavy intake of tea or coffee (more than 9 cups/day) apparently is necessary to cause or significantly increase VPB occurrence, i.e., among the 582 men using 9-10 cups of coffee, 5.3% and among 345 men commonly using eleven or more cups/day, 6.4% were found to have VPB - or expressed differently, 95% and 94% of these heavy coffee drinkers respectively did not show VPB on ECG.

(3) Therefore, abstinence from coffee or tea by the population of middle-aged men would result in a very limited reduction of VPB prevalence. Of the 269 men who had any VPB, 61 or 22.7% drank nine or more cups of tea or coffee/day. Of the 6,983 men who had no VPB, 995 or 14.2% drank a similar amount of coffee or tea. The authors estimated that abstinence from heavy tea or coffee consumption might result in a reduction of VPB prevalence among heavy consumers from 6 to 3%; in this case, the 61 men with VPB among heavy consumers would be reduced to 35 and the overall reduction of VPB prevalence would be roughly 10% ($\frac{61-35}{269} = 9.7\%$).

(4) The same authors have studied the effect of general hygienic advice on adequate sleep, abstinence from alcohol, tobacco, coffee and physical conditioning and found no influence on VPB frequency in otherwise healthy middle-aged men. However, they emphasize these retrospective observations in no way mitigate the prudence of advice to reduce caffeine in cardiac patients having ectopic rhythms.

Coffee and Its Electrophysiologic Properties in Man:

In contrast to the foregoing report on essentially healthy individuals, the article by Gould et al (1979) deals with a meticulously executed study of 12 patients with organic heart disease. With the aid of fluoroscopically positioned electrode catheters, intra-cardiac electrograms were recorded, while simultaneous ECG leads I, II and III were performed. Atrial and ventricular pacing were accomplished; other technical details should be obtained from the original paper. Studies were done twice, first without and then after ingestion of a cup of coffee containing 150 mg. of caffeine. The results showed an improvement in atrioventricular nodal conduction. Since the xanthines are known to stimulate release of catecholamines from the adrenal medulla, the authors concluded that the release of catecholamines following the administration of coffee explains the improvement in conduction through the atrioventricular node. All other conduction measurements showed no difference before and after coffee ingestion. The same authors studied ten additional patients with heart disease and five healthy persons. Hemodynamic measurements were obtained before and 20 minutes after coffee drinking (158 mg. caffeine). With coffee, all of the normal persons demonstrated a rise in the cardiac index and stroke index. In the cardiac patients, coffee produced only minimal changes in these measurements. The cardiac rate, systemic blood pressure, pulmonary artery pressure and left ventricular end-diastolic pressure were essentially unchanged in both groups. None of these patients developed ventricular premature beats or other cardiac dysrhythmias after ingesting coffee. The authors conclude: "The major action of caffeine is not on the heart but on the central nervous system."

Coffee Consumption on Lipids, Lipoproteins and Aortic Atherosclerosis:

Fears (1978) demonstrated after a 4 month period of feeding rats on a caffeine-supplemented high-cholesterol diet, that the histological examination did not detect any damage to the heart and the aorta. This is but one of many recent animal experimental reports which have consistently confirmed the harmlessness of caffeine feeding over prolonged periods. New in this particular paper was the observation that "after 25 days of caffeine feeding in the stock diet, hepatic cholesterologenesis was still increased but the serum cholesterol concentration was the same as in the control rats. During the experiment there was a progressive increase in the faecal excretion of neutral sterols in the rats receiving caffeine."

In agreement with our report (Heyden et al, 1979) that there is no influence of coffee consumption per se on LDL- and HDL-cholesterol in man, Callahan et al (1979) fed rhesus monkeys for 6 months the equivalent of 10 cups of coffee per day in humans and found "no effect on the pattern and composition of the lipoproteins nor on the FFA concentration in serum. Further, there is no obvious morphological difference between the aortic lesions in monkeys fed only the atherogenic diet and the monkeys fed the atherogenic diet plus coffee ... Coffee as generally consumed is not a factor in the development of atherosclerotic cardiovascular disease."

Caffeine and Endurance Performance:

The following are excerpts from a carefully conducted study on the influence of caffeine on two hours of bicycling. This elegant experiment (Ivy et al., 1979), unfortunately, has not received as wide recognition as one would wish in view of its important contribution and practical application. Caffeine treatment (250 mg.) of nine trained cyclists 60 minutes prior to a 2 hour ride and continuing caffeine ingestion with additional 250 mg. in divided doses at 15 minute intervals over the first 90 minutes led to a significantly increased work production over the control period without caffeine. The subjects' perception of exertion remained unchanged. As a result of caffeine's well-known lipolytic activity, plasma FFA levels increased during the last 90 minutes of the ride. As expected, plasma FFA levels rose significantly above pre-exercise levels in both caffeine and the control period. However, the increase in FFA at the completion of the caffeine trial was 30% greater than that of the control trial. During the last 70 minutes of the caffeine trial, fat oxidation was elevated 31% and appeared to provide the substrate needed for the increased work production during this period of exercise. These data, therefore, demonstrate an enhanced rate of lipid catabolism and work production following the ingestion of caffeine.

During the prolonged exercise, the onset of exhaustion is delayed if muscle glycogen is spared. It has been demonstrated that the elevation of plasma FFA results in a diminished dependence on muscle glycogen during exercise due to an increased reliance on fat metabolism. The increased FFA levels delay the onset of exhaustion, presumably due to sparing of muscle glycogen. It is possible that the sparing of muscle glycogen, as a consequence of the increased lipolysis, allowed for the continued increase in work production during the caffeine trial.

No significant differences were detected in the response patterns of glucose and insulin during the caffeine and control trials. Glucose levels increased slightly over the first 30 minutes of exercise and then steadily declined during the last 90 minutes. On the other hand, insulin levels began to decline with the onset of exercise and continued throughout the first 90 minutes of each trial.

Caffeine and Mutagenicity:

The main problem with the study of mutagens in coffee is the repeated failure to confirm in in-vivo experiments the various mutagenic effects observed with caffeine in in-vitro systems. A recent paper by Nagao et al. (1979) adds some more questionmarks even to the in-vitro findings. Coffee prepared in the usual way for drinking was shown to be mutagenic in *Salmonella typhimurium* TA 100; instant regular coffee and also caffeine-free instant coffee showed similar mutagenicity. Thus, the authors concluded, the mutagenic activity was not due to caffeine, theophylline or theobromine since they per se were not mutagenic to *Salmonella typhimurium* and caffeine-free instant coffee was mutagenic similarly to the ordinary instant coffee.

Aeschbacher et al (1978) did the decisive in-vivo animal experiment by using 100 mg. of caffeine per kg. body weight per day in mice which represents an ingestion of at least 60 cups of coffee per day for humans. No mutagenic induction of dominant lethals, pre-implantation egg loss or depression of the fertility of females was observed. The half-life of caffeine was similar in plasma and testicular tissue - between 2.5 and 3 hours. Caffeine did not accumulate in the testicular tissue of mice. The maximum concentration of caffeine found was below 10 µg/g testicular tissue, which is about 100 times lower than concentrations that cause chromosome aberrations in cultured mammalian cells. Extrapolating the obtained tissue concentration in mouse testicles to humans, the authors found that the concentration at the target cells of a human coffee drinker would be about a 1,000 times lower than that concentration which caused chromosome breakage in leukocyte and HeLa-cell cultures.

Coffee and Tumor Induction in Animals:

In an experiment carried out by Mori and Hirono (1977) in five groups of rats over 480 days, the following regimens were devised. Group 1, coffee alone; Group 2, coffee plus cycasin; Group 3, cycasin plus coffee; Group 4, cycasin alone; Group 5, control. The 'coffee-alone' group did not develop any tumor, Group 2 and 3 developed four and six tumors at different organ sites, respectively; the 'cycasin-alone' group and the control group, each developed one single tumor. The authors concluded that the combination of coffee and cycasin caused a significant interaction effect, resulting in tumor induction. However, the number of tumors is small and it should be noted that in Group 2, one tumor was diagnosed as leukemia, whereas one tumor in Group 3 was found to be an ear duct squamous cell carcinoma, both rather rare, unusual in this type of experimental setting. In addition, the control group as well as Group 2 and 3 contained one breast adenoma. Obviously, those tumors must be discounted from the overall tumor induction. We are then faced with the possibility that colon and rectum adenomas might be induced by the combined application of cycasin and coffee, but the total numbers, two tumors in Group 3, leave serious reservations as to the biological significance of this finding. We have earlier reviewed the literature on "coffee and cancer" in humans. We remain impressed by the absence of epidemiological evidence linking coffee consumption with colon cancer. Higginson et al. and Wynder et al. concluded this from comparisons of coffee drinking habits among colon cancer patients and those of matched controls.

Another group of Japanese investigators (Hiroshi and Tanooka, 1979) claimed that caffeine enhances skin tumor induction in mice. However, careful review of the methodology leaves doubts as to the validity of the experimental design. One hundred mice were irradiated on the backs, followed by painting with a carcinogen 4 NQO, 0.1 mg. each, dissolved in benzene at 5 mg. per ml., 20 paintings after a 10 day interval. In another 100 mice, caffeine, 0.8 mg. each, dissolved in benzene at 10 mg. per ml., was additionally painted on the same skin site on alternate days of the 4 NQO painting. Thus, the control-mice only received a total of 5 mg. benzene every day. After 94 weeks, the control animals showed a tumor incidence of 26% whereas the caffeine treated animals had almost double this incidence, 49%. Benzene, however, was not taken into consideration in the induction of skin cancers. It appears reasonable to question the possibility that not

caffeine but the sizable difference in benzene painting may have caused the higher skin cancer incidence. This report also contradicts a number of opposite findings quoted by the authors, e.g., that "caffeine suppresses skin tumor induction with ultraviolet light or cigarette smoke condensate and lung tumor induction with the carcinogen 4 NQO or urethane. The parallelism in the suppressing effects of caffeine on mutation induction in bacteria, malignant transformation in cultured mammalian cells and tumor induction, was suggested as a model for testing the mutation theory of cancer." Therefore, these results on the allegedly enhancing effect of caffeine on tumor incidence in carcinogen-treated mouse skin stand to be corroborated.

Coffee and Benign Prostatic Hypertrophy:

The Boston Collaborative Drug Surveillance Program first came to international attention with its slightly sensational report on an alleged association between coffee drinking and myocardial infarction - a report which triggered several long-term prospective investigations all of which eventually denied any relationship. In 1978, Morrison from the same group, reported that "smokers appeared to be at lower risk of BPH than nonsmokers. Little decrease in risk with amount smoked was evident; the risk of ex-smokers was intermediate between that for nonsmokers and that for current smokers. This result suggests that if there is a protective effect of smoking (sic!), the effect tends to disappear when smoking is discontinued." The author quotes from two studies (1974, 1975) which seem to corroborate the finding that a lower proportion of smokers was among BPH cases compared to controls. The author continues: "A small elevation of risk for coffee drinkers was observed. The risk ratio for this exposure, 1.3, is virtually identical to that reported by others." In the discussion of the findings, two reports are cited, correlating a positive association between national death rates from prostatic cancer and per capita rates of coffee importation. We have previously commented on the very questionable methodology, correlating per capita rates of coffee importation among different countries with national prostate cancer death rates. In addition, prostate cancer and BPH are unrelated diseases and there is no reason to believe that BPH predisposes to prostate cancer.

The unlikely advice resulting from this report by Morrison would call for continuation of cigarette smoking and quitting coffee drinking in order "to avoid" the development of BPH, an advice which may only generate more disbelief in purely statistical associations.

Caffeine's Influence on Spermatozoa:

The exogenous addition of caffeine to spermatozoa is known to increase the motility, life-span and forward progression. Harrison (1978) confirmed the motility but noted the absence of an improvement in results of artificial insemination. Although good motility is not enough in itself to ensure fertilization, it probably plays an important role. The author explained the disappointing result, i.e., the failure to achieve pregnancies, with the poor semen specimens in the majority of samples in his series. Another experimental design is indicated using high-quality spermatozoa in artificial insemination.

Caffeine in the Treatment of Depressed Asphyxiated Newborns:

Caffeine is a powerful stimulant of the CNS, causing stimulation of all portions of the cortex, as well as the medullary centers of respiration and vasomotor and vagal control. According to Kulkarni and Dorand (1979), it is not uncommon to receive infants previously treated with caffeine into neonatal intensive care units. It is remarkable that their review of the literature did not reveal any report on caffeine toxicity in neonates. They observed a newborn who had received 125 mg. of caffeine at 20 minutes of age and 250 mg. again at 30 minutes of age. At 16 hours of age, the infant became extremely jittery and tachypneic. At 26 hours and 36 hours of age, the serum caffeine levels were 55 and 52 mg./l., respectively. Therapeutic levels are considered between 20 and 30 mg./l., and serum levels exceeding 40 mg./l. are thought toxic for infants. By 84 hours of age, this infant was asymptomatic, with a caffeine serum concentration of 28 mg./l. The sequential

serum levels obtained from this patient confirm the significantly prolonged half-life of caffeine in neonates. As much as 20-fold prolongation of half-life of caffeine in human neonates relative to adults has been reported. Among children, caffeine poisoning was reported resulting in death when doses between 3 and 18 g. had been received.

Caffeine and Pregnancy:

A group of investigators at the University of Illinois (Urbana-Champaign) has repeatedly quoted from their retrospective study of Mormon women, a minor segment of whom obviously did not follow the religion's proscription of coffee intake. Weathersbee et al (1977, 1978, 1979) found 16 women who estimated their average caffeine intake at 600 mg. per day. Of these women, only one had an uncomplicated pregnancy and delivery, while 15 pregnancies ended in spontaneous abortions, stillborn and premature birth. The authors admitted that they had not taken questionnaire histories on smoking and alcohol intake.

In their review paper on ethanol's effect on the reproductive process, Weathersbee and Lodge (1978) correctly describe the present concept of physiological mechanisms of fetal alcohol syndrome (FAS) but incorrectly speculate on similarities of "the use of alcohol, caffeine and cigarettes during the prenatal period." It is remarkable that these investigators failed to consider even the FAS in any of the 16 women described earlier. Also of interest is the reference to the applicability of the animal model to humans: "In the case of ethanol, the human and animal models are similar; however, for the related habit of caffeine, rat fetuses can apparently metabolize the drug, whereas humans cannot." This difference obviously renders animal experiments with these two drugs in combination inapplicable to man. Therefore, the hypothesis that caffeine disrupts the fetal cyclic nucleotide balance and may account for the increase in fetal death rates (which they observed in litters of females treated with caffeine during pregnancy) remains hypothetical and should not be translated into official warnings to abstain from coffee during pregnancy, whereas such warnings are clearly indicated in the case of alcohol and cigarettes.

The anecdotal report that "infants born to high coffee consuming mothers had lower levels of activity and were more hypotonic than infants of low caffeine consumers" is but one of several objectionable statements. In their most recent review paper (1979) the authors make another plea for "considering alcohol, caffeine and nicotine as a group until clarifying data can be derived." How clarification can be achieved by summarily lumping the three habits in review articles without controlling for each one in a multivariate analysis remains to be demonstrated by the authors. There is sufficient evidence in the literature to imply alcohol per se in human pregnancy (but not necessarily in all animal species) and nicotine per se (Naeye, 1979; Mau and Netter, 1974) as causally linked to fetal and placental disorders, perinatal mortality and the incidence of malformations.

Caffeine Interaction with Aspirin in the Rat:

At high doses of aspirin (40 mg./kg.) and caffeine (5 mg./kg.) hyperactivity was induced in rats (Collins et al, 1979). Caffeine-induced hyperactivity lasted only for 2 hours, but that due to aspirin was evident from 1-6 hours after dosing. Co-administration of the two drugs caused long-lasting hyperactivity, even with doses of aspirin which had no stimulant effect themselves. "The most likely effect is that of salicylate on catecholamine utilization in the central nervous system, which is compounded in the presence of a phosphodiesterase inhibitor."

Contributions to the literature pertaining to "coffee and health" by Dr. S. Heyden.

1. Aeschbacher HU, Milon H, and Wurzner HP: Caffeine concentrations in mice plasma and testicular tissue and the effect of caffeine on the dominant lethal test. *Mutat. Res.* 57:193, 1978.
2. Callahan MM, Rohovsky MW, Robertson RS, and Yesair DW: The effect of coffee consumption on plasma lipids, lipoproteins, and the development of aortic atherosclerosis in rhesus monkeys fed an atherogenic diet. *Amer. J. Clin. Nutr.* 32:834, 1979.
3. Collins C, Laird RI, Richards PT, Starmer GA, and Weyraugh S: Aspirin-caffeine interaction in the rat. *J. Pharm. Pharmacol.* 31:611, 1979.
4. Fears R: The hypercholesterolaemic effect of caffeine in rats fed on diets with and without supplementary cholesterol. *Br. J. Nutr.* 39:363, 1978.
5. Gould L, Reddy CVR, Chang OhK, Kim SG, and Becker W: Electrophysiologic properties of coffee in man. *J. Clin. Pharm.* (January) p. 46, 1979.
6. Graham DM: Caffeine - Its identity, dietary sources, intake and biological effects. *Nutr. Rev.* 36:97, 1978.
7. Harrison RF: Insemination of husband's semen with and without the addition of caffeine. *Fert. Ster.* 29:532, 1978.
8. Hoshino H, and Tanooka H: Caffeine enhances skin tumor induction in mice. *Toxicol. Lett.* 4:83, 1979.
9. Ivy JL, Costill DL, Fink WJ, and Lower RW: Influence of caffeine and carbohydrate feedings on endurance performance. *Med. Sci. Sports* 11:6, 1979.
10. Kulkarni PB, and Dorand RD: Caffeine toxicity in a Neonate. *Pediatr.* 64:254, 1979.
11. Leydhecker W: Influence of coffee upon ocular tension: in normal and glaucomatous eyes. *Amer. J. Ophthalm.* 39:700, 1955.
12. Mau G, and Netter P: The effects of paternal cigarette smoking on perinatal mortality and the incidence of malformations. *German Medical Weekly* 99:1113, 1974.
13. Mettlin C, and Graham S: Dietary risk factors in human bladder cancer. *Amer. J. Epidem.* 110:255, 1979.
14. Minton JP, Foecking MK, Webster DJT, and Matthews RH: Caffeine, cyclic nucleotides, and breast disease. *Surg.* 86:105, 1979.
15. Minton JP, Foecking MK, Webster DJT, and Matthews RH: Response of fibrocystic disease to caffeine withdrawal and correlation of cyclic nucleotides with breast disease. *Amer. J. Obstet. Gynecol.* 135:157, 1979.
16. Mori H, and Hirono I: Effect of coffee on carcinogenicity of cycasin. *Br. J. Cancer* 35:369, 1977.
17. Morrison AS: Prostatic hypertrophy in greater Boston. *J. Chron. Dis.* 31:357, 1978.
18. Naeye RL: The duration of maternal cigarette smoking, fetal and placental disorders. *Early Human Developm.* 3:229, 1979.
19. Prineas RJ, Jacobs DR, Crow RS, and Blackburn H: Coffee, tea and VPB. *J. Chron. Dis.* 33:67-72, 1980.
20. Regan TJ: Of beverages, cigarettes, and cardiac arrhythmias. *N. Engl. J. Med.* 301:1060, 1979.

21. Thomas CB: Precursors of premature disease and death. The predictive potential of habits and family attitudes. *Ann. Int. Med.* 85:653, 1976.
22. Turnberg LA: Coffee and the gastrointestinal tract. *Gastroenterol.* 75:529, 1978.
23. Weathersbee PS, and Lodge JR: Alcohol, caffeine, and nicotine as factors in pregnancy. *Postgrad. Med.* 66:165, 1979.
24. Weathersbee PS, Olsen LK, and Lodge JR: Topics in primary care. Caffeine and pregnancy. *Postgrad. Med.* 62:64, 1977.
25. Weathersbee PS, and Lodge JR: A review of ethanol's effect on the reproductive process. *J. Reprod. Med.* 21:63, 1978.

APPENDIX:

1. Heyden S, and Ruttner JR: The influence of caffeine on serum cholesterol in the animal experiment. *Path. Microbiol.* 29:291, 1966. (German)
2. Heyden S: Does coffee influence the lipid metabolism? *J. Nutr. Sci.* 9:388, 1969. (English)
3. Heyden S, DeMaria W, Johnston WW, and O'Fallon WM: Caffeine effects on cholesterol and development of aortic and coronary atherosclerosis in rabbits. *J. Chron. Dis.* 21:677, 1969. (English)
4. Heyden S, Bartel A, Cassel JC, Hames CG, Tyroler HA, and Meier R: Coffee, vascular diseases and risk factors. *J. Nutr. Sci. Suppl.* 14:1, 1972. (German)
5. Heyden S: Coffee consumption and cancer etiology: no causal relationship. *J. Nutr. Sci. Suppl.* 14:11, 1972. (German)
6. Heyden S, and Escher M: Coffee consumption from the medical standpoint. *Swiss Med. J.* 103:1509, 1973. (German)
7. Heyden S, and Escher M: Is coffee dangerous? Questionnaire study among lay persons and physicians. *Swiss Review of Med. Praxis* 62:1449, 1973. (German)
8. Heyden S: Caffeine under attack - how much longer? *Nutr. Metab.* 17:261, 1974. (German)
9. Heyden S: In favor of the strong coffee drinker - 6:1. *Med. Trib.* (German edition) 11:21, 1976.
10. Heyden S: Are there contraindications against the use of coffee? *Therapy* 115:805, 1976. (German)
11. Heyden S: Harmless caffeine. *Mat. Med. Nordmark* 29:273, 1977. (German)
12. Heyden S, Tyroler HA, Heiss G, Hames CG, and Bartel A: Coffee consumption and mortality. Total mortality, stroke mortality and coronary heart disease mortality. *Arch. Int. Med.* 138:1472, 1978. (English)
13. Heyden S, Heiss G, Manegold Ch, Tyroler HA, Hames CG, Bartel AG, and Cooper G: The combined effect of smoking and coffee drinking on LDL and HDL cholesterol. *Circulation* 60:22, 1979. (English)
14. Heyden S, Heyden F, Heiss G, and Hames CG: Smoking and coffee consumption in three groups: cancer deaths, cardiovascular deaths and living controls. A prospective study in Evans County, Georgia. *J. Chronic Dis.* 32:673, 1979. (English)
15. Heyden S: Coffee and fibrocystic disease. Accepted for publication: *Surgery*, 1980. (English)

HUMAN METABOLISM OF RADIOLABELED CAFFEINE FOLLOWING ORAL ADMINISTRATION



M.M.
Callahan

M. M. CALLAHAN, R. ROBERTSON, A. R. BRANFMAN,

M. McCOMISH, D. W. YESAIR

Arthur D. Little, Inc.,

Cambridge, Massachusetts 02140 U.S.A.

(Supported by the members of the National Coffee Association)

The pharmacological activity of caffeine has long been appreciated. It is thus surprising that in spite of this high interest and long history of use, studies on the human metabolism of caffeine are somewhat limited. Our present study involved administering radiolabeled caffeine to human volunteers and executing an extensive characterization of the resulting urinary metabolites. By using radiolabeled caffeine, we were able to account for approximately 90% of the administered dose; identify greater than 95% of the urinary radioactivity as specific metabolites; and, also, identify an important urinary metabolite whose primary source is caffeine and in our subjects was present in concentrations ranging from 7-35% of the administered radiolabeled caffeine.

The study, as outlined in Figure 1, was organized on a crossover basis. In the first leg, one group of 4 subjects received a single dose of 2-¹⁴C-caffeine and the other group of 4 received 1-methyl-¹⁴C-caffeine. In the second leg, following a two-week interval, the first group received the 1-methyl-¹⁴C-caffeine and the second the 2-¹⁴C-caffeine. The total oral dose administered each time was 5 milligrams per kilogram, which is equivalent to about 3 or 4 cups of coffee. The specific activity of both labeled compounds was such that each dose did not exceed 50 microcuries per individual or 100 microcuries per individual for the total study.

Urine, serum, saliva, CO₂ production and feces were collected at specific intervals for 48 hours post dosing.

Some of the following figures may show results from more than eight subjects as this study was actually started twice, with two different groups of eight subjects each, but the complete crossover design was carried through with only one group of eight.

High performance liquid chromatography, HPLC, in conjunction with liquid scintillation counting, was used to determine caffeine and metabolite concentrations in the serum and saliva samples.

FIGURE 1 HUMAN METABOLISM STUDY FOLLOWING ORAL DOSING WITH RADIO-

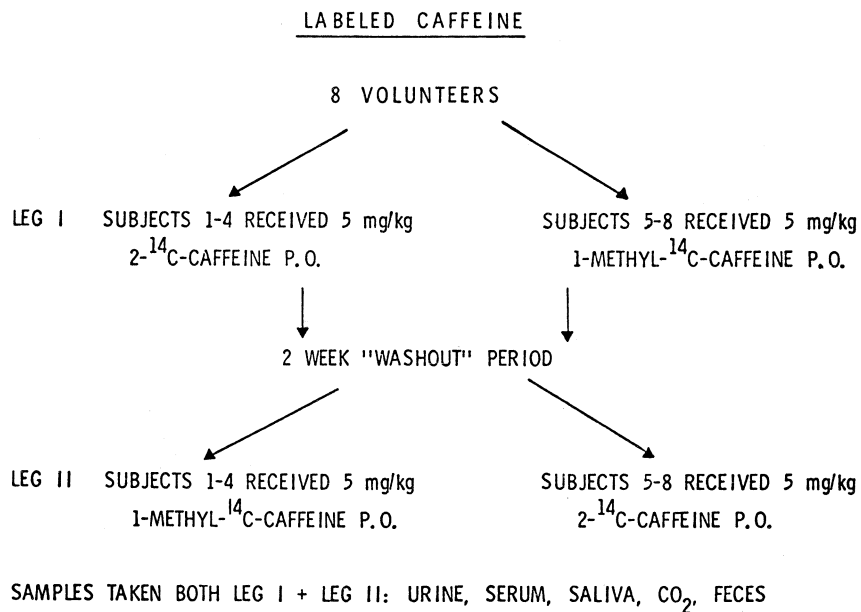
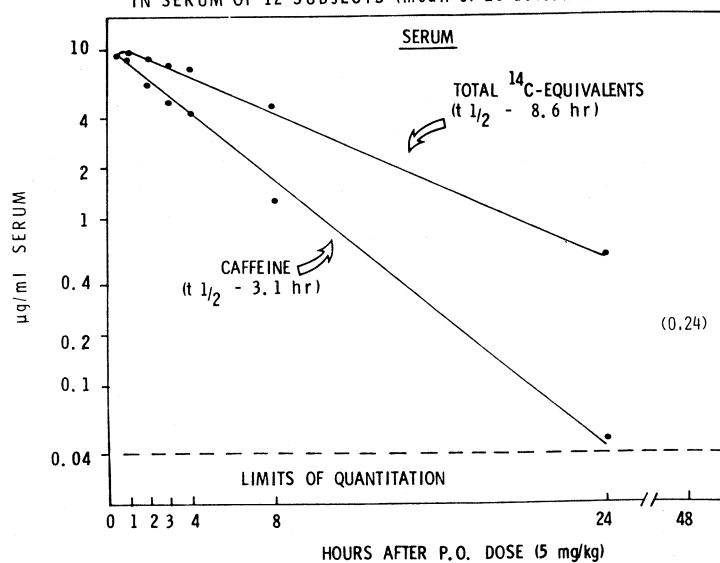

Figure 2 shows the kinetics of radiolabeled caffeine in serum. In these subjects, caffeine had a serum half-life of approximately 3 hours which probably reflects a metabolic half-life. The top line represents values obtained by counting total radioactivity - this would, of course, include caffeine plus metabolites. The half-life for total radiolabeled equivalents in serum was approximately 8 hours, which we interpret as the half-life for excretion.

Similar results obtained with saliva are shown in Figure 3. Again, the half-life of caffeine was approximately 3.0 hours and one sees a longer half-life of total radiolabeled equivalents, approximating 7 hours. We found with our samples that the absolute concentration of caffeine in saliva was about 65% of that found in serum.

FIGURE 2 KINETICS OF EITHER 1-METHYL-¹⁴C- OR 2-¹⁴C-CAFFEINE IN SERUM OF 12 SUBJECTS (mean of 20 determinations)



KINETICS OF EITHER 1-METHYL-¹⁴C- OR 2-¹⁴C-CAFFEINE
IN SALIVA OF 12 SUBJECTS (mean of 20 determinations)

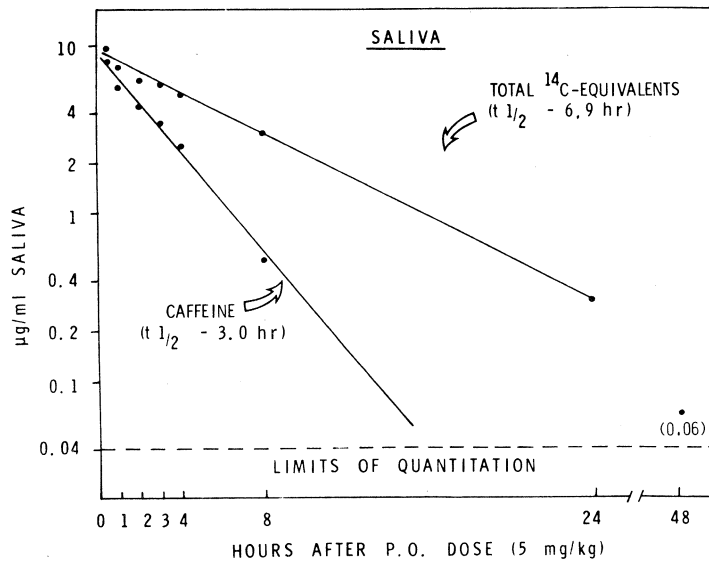

FIGURE 3

COMPARISON OF CAFFEINE METABOLITES IN SERUM AND SALIVA
FOLLOWING AN ORAL DOSE OF 5 mg/kg RADIOLABELED CAFFEINE
TO HUMAN VOLUNTEERS

	COLLECTION PERIOD (HOURS POST DOSE)											
	0,5		1		2		3		4		8	
µg CAFFEINE EQUIVALENTS/ ML*	SER	SAL	SER	SAL	SER	SAL	SER	SAL	SER	SAL	SER	SAL
TOTAL ¹⁴ C EQUIVALENTS	8.2	16.2	9.1	7.7	9.4	6.7	8.8	6.3	8.5	6.0	6.4	5.0
1,3,7-X	6.3	13.0	6.7	6.1	6.1	4.8	5.3	4.2	4.7	3.6	2.6	2.0
1,7-X/1,3-X	0.6	0.4	0.9	0.7	1.5	1.0	1.8	1.3	2.1	1.4	2.4	1.7
3,7-X	0.2	0.7	0.2	0.3	0.3	0.3	0.4	0.4	0.4	0.5	0.4	0.5
SUM	7.1	14.1	7.8	7.1	7.9	6.1	7.5	5.9	7.2	5.5	5.4	4.2
% OF TOTAL EQUIVALENTS ACCOUNTED FOR BY SUM	86	87	86	91	83	91	85	92	85	92	82	82
% OF TOTAL EQUIVALENTS ACCOUNTED FOR BY CAFFEINE	77	80	74	79	64	71	60	66	56	61	40	40

*MEAN OF 4 INDIVIDUALS EXCEPT THEOBROMINE VALUES WHICH ARE AVERAGE OF 2 INDIVIDUALS

FIGURE 4

Representative serum and saliva samples from four subjects, two administered 2-¹⁴C-caffeine and two 1-methyl-¹⁴C-caffeine, were also analyzed for metabolites arising from the radiolabeled doses.

The results are summarized in Figure 4. The major metabolites in both serum and saliva were the dimethylxanthines. Let me briefly explain the abbreviation system we used for these figures. Xanthine is abbreviated by X and uric acid by U with the pre-numbers referring to the position of the various methyl groups; thus on this slide, caffeine is 1,3,7-X, paraxanthine is 1,7-X, theophylline 1,3-X, and theobromine 3,7-X. The HPLC system we used for analysis, which will be outlined in a later slide, does not resolve paraxanthine from theophylline but, based on our urine work and the reports of other investigators, paraxanthine is the major dimethylxanthine produced by humans.

With the exception of the half hour samples, the saliva values parallel the serum but the absolute concentrations are less. The sum of caffeine and the dimethylxanthines in both serum and saliva account for approximately 87% of the total ¹⁴C-equivalents, with caffeine representing a decreasing percentage of these equivalents with time.

The excretion of total radiolabeled equivalents in urine from all subjects is illustrated in Figure 5. At the end of 48 hours, 69% of the 1-methyl-¹⁴C-caffeine dose and 80% of the 2-¹⁴C-caffeine dose was excreted in the urine. The difference undoubtedly is associated with metabolism at the 1-methyl position.

Figure 6 summarizes the excretion of ¹⁴C-caffeine equivalents for the eight subjects in the crossover study in terms of cumulative percent of dose over the total collection period of 0-48 hours. The urinary excretion of 1-methyl-labeled caffeine equivalents for these subjects averaged about 72% of the administered dose while approximately 85% of the 2-ring-labeled dose was found at the end of 48 hours.

An estimate can be made of the metabolism that occurred at the 1-methyl-position by comparing the kinds of metabolites found in these urine samples. This exercise results in an average value of approximately 10%, which correlates nicely with the differences seen in urinary excretion. The CO₂ data, however, accounted for only 1-2% of the 1-

FIGURE 5

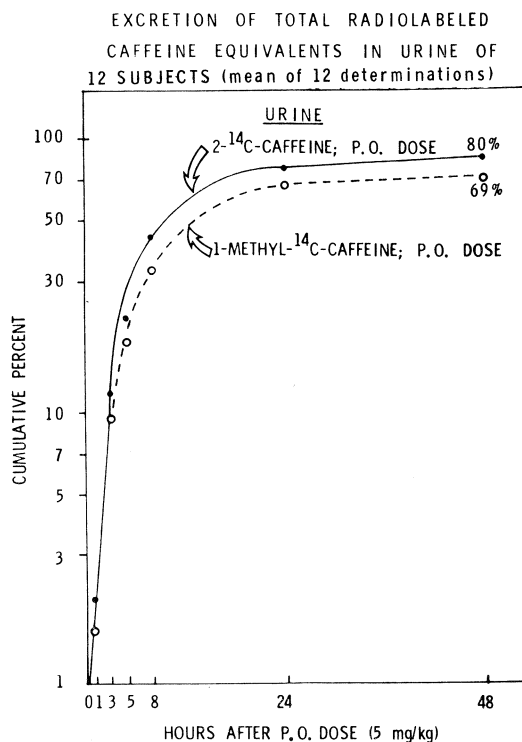

TOTAL ¹⁴C-CAFFEINE EQUIVALENTS EXCRETED IN HUMANS FOLLOWING AN ORAL DOSE (5 MG/KG) OF
RADIOLABELED CAFFEINE

SUBJECTS	CUMULATIVE PERCENT OF DOSE (0-48 HR)							
	1-METHYL- ¹⁴ C-CAFFEINE				2- ¹⁴ C CAFFEINE			
	URINE	FECES	TOTAL	CO ₂ *	URINE	FECES	TOTAL	1-CARBON POOL**
1	70	2.1	72.1	0.8	87	1.6	88.6	9.3
2	74	3.5	77.5	1.3	76	1.0	77.0	6.2
3	65	0.7	65.7	1.7	87	1.1	88.1	8.0
4	77	3.2	80.2	1.2	90	0.4	90.4	11.9
5	75	2.2	77.2	1.1	91	4.3	95.3	13.7
6	70	2.2	72.2	1.1	89	4.7	93.7	15.1
7	73	2.2	75.2	1.5	84	0.5	84.5	11.2
8	76	0.7	76.7	1.4	82	2.6	84.6	9.2

* INTEGRATED OVER FIRST 8 HR POST DOSE

** ESTIMATE OF METABOLISM AT 1-METHYL POSITION

FIGURE 6

methyl labeled dose but here we must fault our collection method as recent work by Arnaud and others have directly correlated the loss of the methyl group with its appearance in CO₂. Total radiolabeled equivalents in feces contained an additional 2-5% of the administered radiolabeled caffeine at the end of 48 hours.

The primary HPLC method we used in conjunction with liquid scintillation counting is outlined in Figure 7. Essentially, it is an adaptation of the method developed by Neims, Aldridge and co-workers when they were at McGill University in Montreal.

Figure 8 shows a chromatogram of 15 standards run under these conditions. With so many structurally similar metabolites arising from caffeine it is currently not possible to find one chromatographic system which will cleanly separate all the xanthenes and uric acids. In this system, which we refer to as System 1, the following compounds co-chromatographed:

- 7-methylxanthine with 1-methyluric acid;
- theophylline with paraxanthine, and
- 3,7-dimethyluric acid with 1-methylxanthine, although it is not labeled on this slide.

An example of the results obtained with a typical 2-ring-labeled sample, Person 4, 3-5 hour collection period, is shown in Figure 9. We found a small amount of caffeine excreted in the urine and several larger radiolabeled areas. The 1,3,7-trimethyluric acid peak is small and we conclude, in agreement with other workers, that this is not an important pathway in humans. The double peak of theophylline and paraxanthine is pushed together with the 1,7-dimethyluric acid peak and they are approximately equal. We found a little theobromine and 1,3-dimethyluric acid, with large amounts of 1-methylxanthine and 1-methyluric acid, the latter peak also containing 3-methyl- and 7-methylxanthine. In addition, we found two large radiolabeled areas which did not correspond to any known metabolites.

PREPARATION OF URINE FOR ANALYSIS BY HPLC (SYSTEM 1)

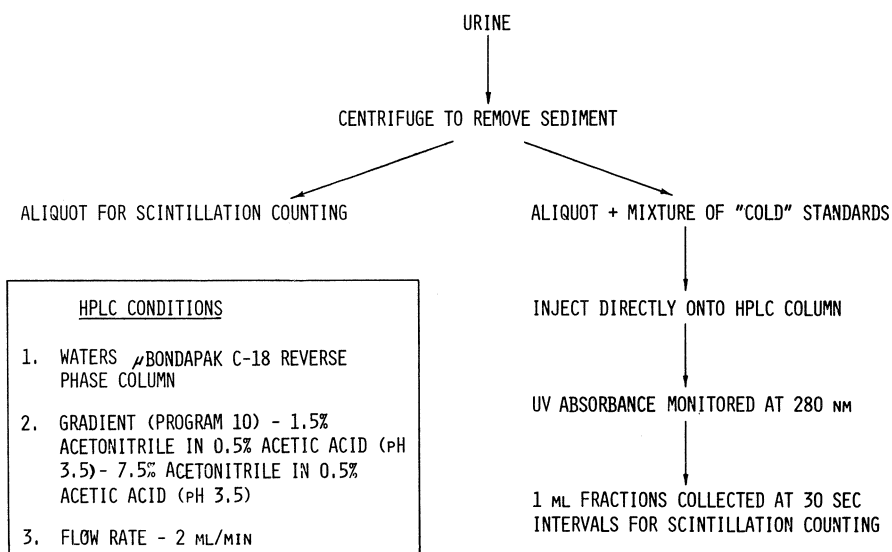

FIGURE 7

HPLC CHROMATOGRAM (SYSTEM 1) - 15 STANDARDS

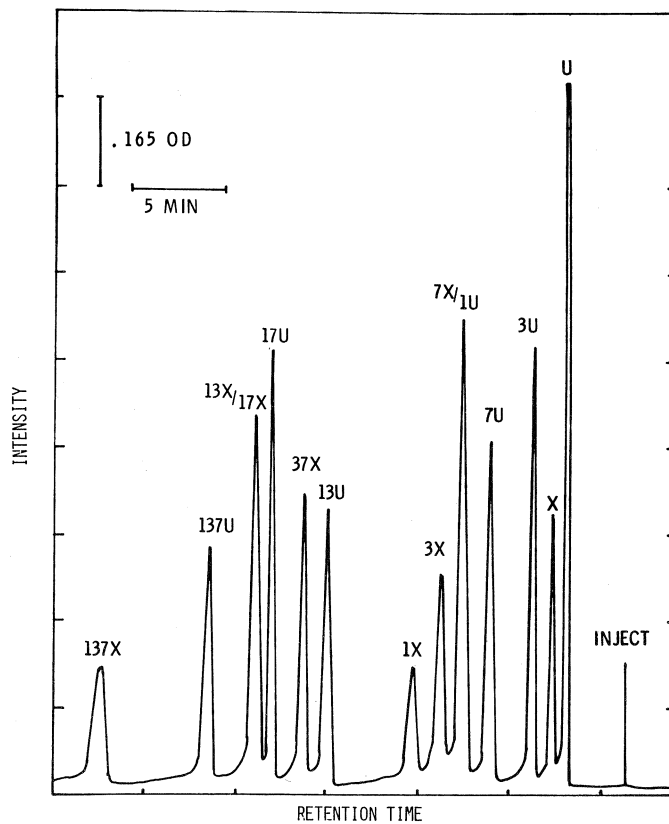

FIGURE 8

HPLC CHROMATOGRAM (SYSTEM 1)
P₄ L₁, 3-5 HOURS + 15 STANDARDS

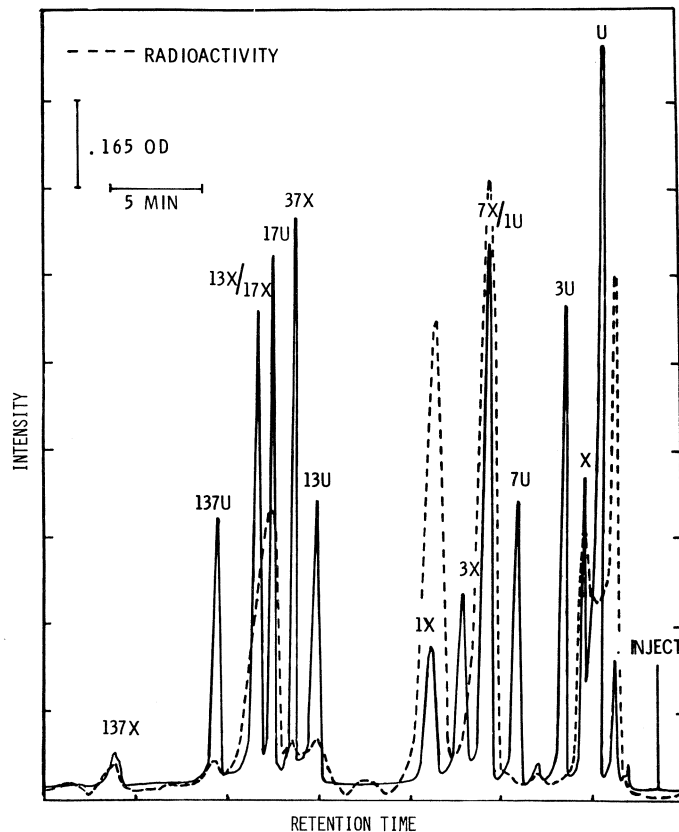

FIGURE 9

Figure 10 illustrates a chromatogram from the same person, Person 4, from the same 3-5 hour collection period, but after dosing with the 1-methyl-labeled caffeine. When the 1-methyl group is metabolized, the resulting metabolites are, of course, no longer radioactive. Thus on this chromatogram there is no radioactive theobromine peak. Also, the radioactivity in the 1-methylxanthine peak contains no contribution from 3,7-dimethyluric acid and the 1-methyluric acid peak is uncontaminated by 3-methyl- or 7-methylxanthine. However, we again found the large unknown radiolabeled areas noted on the previous slide and which at this time we called A₁ and A₂.

A summary of the results obtained by analyzing all the 2-ring-labeled and 1-methyl-labeled samples using HPLC System 1 is shown in Figure 11. With this slide one can clearly see the kind of information we obtained by using the two different forms of radiolabeled caffeine. The results for 1-methyluric acid in subjects dosed with 1-methyl-¹⁴C-caffeine are minus the contributions of 3-methylxanthine and 7-methylxanthine which would co-elute with it, a loss of approximately 10%. There is no significant change in the results for 1-methylxanthine which strongly suggests that little if any 3,7-dimethyluric acid is produced in humans. The amounts of A₁ and A₂ were similar with both labels. The major human urinary metabolites with both forms of radiolabeled caffeine were 1-methyluric acid, 1-methylxanthine, and A₁. The values on this slide are means for 10 subjects. The only metabolite that had a large standard deviation, relatively speaking, was A₁ which ranged from 7-35% of the dose in these subjects. These metabolites represent approximately 77 and 67% of the 2-ring-labeled and 1-methyl-labeled caffeine dose, respectively, but in both cases approximately 97% of the

HPLC CHROMATOGRAM (SYSTEM 1) - P₄ L₂, 3-5 HOURS + 15 STANDARDS

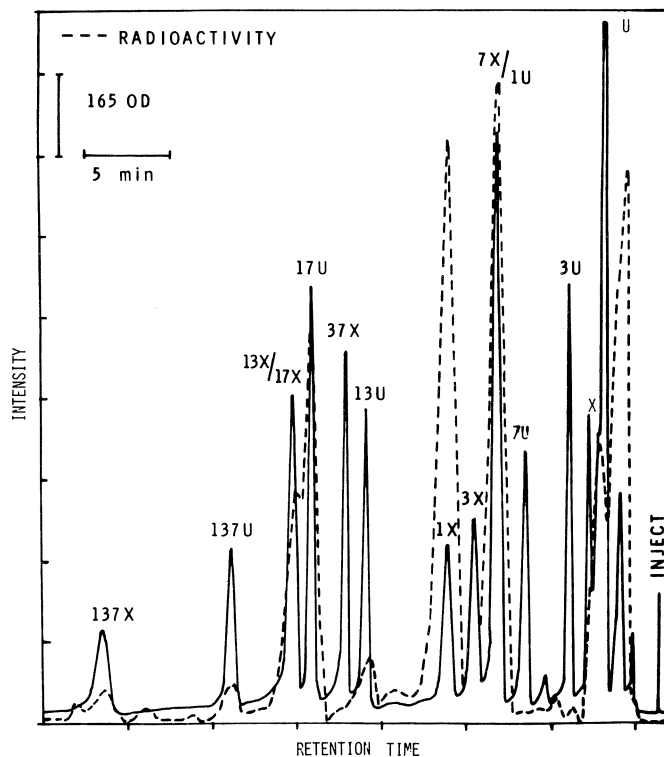

FIGURE 10

total urinary radioactivity. Dr. Maurice Arnaud of Nestle also analyzed some of our urine samples using his two-dimensional thin layer chromatographic system and found 1-2% of the dose present as 4-amino-5-[N-methyl-formylamino]-1,3-dimethyluracil. This metabolite is difficult to quantitate by HPLC since it is both a minor component in human urine and it co-chromatographs as a double peak with 1,3-dimethyluric acid and 3-methylxanthine in our HPLC System 1.

In order to resolve the multiple peak areas for the identified caffeine metabolites, we analyzed some of the urines using another HPLC system, outlined in Figure 12, which was developed by Dr. H. Dix Christensen of the University of Oklahoma. We refer to this HPLC system as System 2.

Figure 13 combines and summarizes the results of analyzing urine from four of our 2-ring-label dosed subjects using both HPLC Systems 1 and 2. Only about 1% of the dose is recovered as caffeine; 1-methylxanthine, 1-methyluric acid and A₁ are the major metabolites accounting for approximately 50% of the dose in these four subjects; the other monomethylxanthines, 3-methylxanthine and 7-methylxanthine account for an additional 4 and 10%, respectively. Paraxanthine is the major dimethylxanthine at approximately 6% of the dose and 1,7-dimethyluric acid, the major dimethyluric acid derivative at approximately 5%. Again, all the metabolites listed in this slide account for approximately 83% of the dose and 98% of the total urinary radioactivity.

CAFFEINE METABOLITES EXCRETED IN HUMAN URINE ARISING FROM AN ORAL DOSE (5 MG/KG)
OF RADIOLABELED CAFFEINE-HPLC RESULTS (SYSTEM 1)

PERCENT OF ADMINISTERED 2- ¹⁴ C-CAFFEINE DOSE*		PERCENT OF ADMINISTERED 1-METHYL- ¹⁴ C-CAFFEINE DOSE*	
METABOLITES	TOTAL 0-48 HR COLLECTION	METABOLITES	TOTAL 0-48 HR COLLECTION
1-U/3-X + 7-X	25.55	1-U	16.97
1-X/3,7-U	16.31	1-X	14.67
1,3-U	2.05	1,3-U	2.49
3,7-X	1.57		
1,7-U	4.31	1,7-U	4.70
1,3-X/1,7-X	5.70	1,3-X/1,7-X	4.80
1,3,7-U	1.09	1,3,7-U	0.91
1,3,7-X	1.10	1,3,7-X	0.78
A ₁	16.40	A ₁	17.76
A ₂	3.18	A ₂	3.86
TOTAL % OF DOSE	77.26		66.94
TOTAL % OF URINARY RADIOACTIVITY	96.57		97.01

*MEAN OF 10 SUBJECTS

FIGURE 11

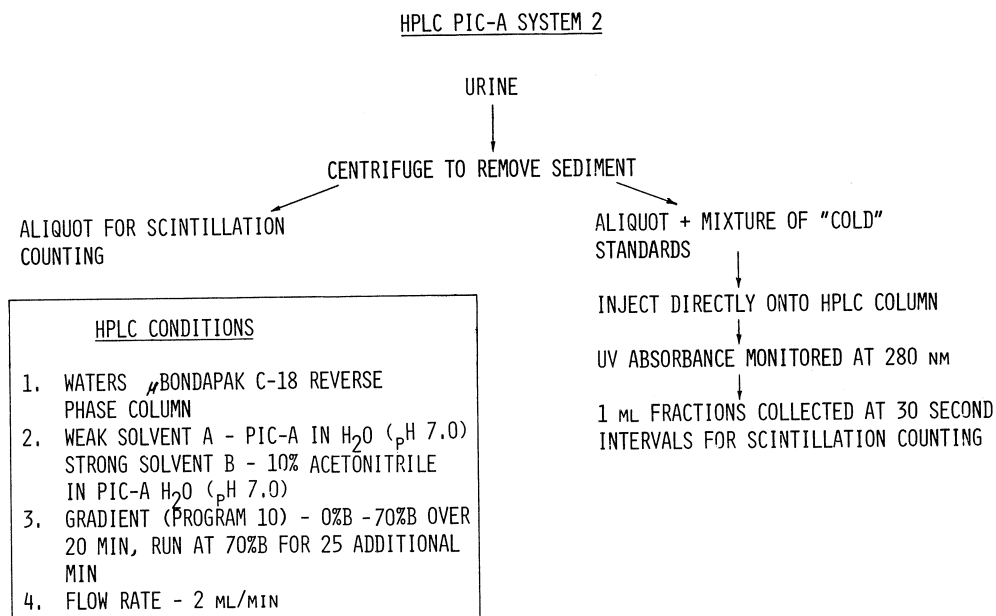

FIGURE 12

CAFFEINE METABOLITES EXCRETED IN HUMAN URINE ARISING FROM AN
ORAL DOSE (5 MG/KG) OF 2-¹⁴C-CAFFEINE-HPLC RESULTS (SYSTEMS 1 + 2)

METABOLITES	PERCENT OF ADMINISTERED DOSE* TOTAL 0-48 HR COLLECTION
A ₁	14.70
A ₂	3.17
1-X	18.14
3-X	4.11
7-X	9.88
1,3-X	0.89
1,7-X	5.86
3,7-X	1.88
1,3,7-X	1.24
1-U	14.81
1,3-U	1.80
1,7-U	5.36
1,3,7-U	<u>1.30</u>
TOTAL % OF DOSE	83.14
TOTAL % OF URINARY RADIOACTIVITY	98.68
*MEAN OF 4 SUBJECTS	

FIGURE 13

One of the major findings of this study was that in the course of quantifying the urinary metabolites, our analytical HPLC systems partially resolved two radiolabeled polar metabolites which we termed A₁ and A₂. In our eight individuals these two polar metabolites ranged from 10-40% of both radiolabeled administered doses and A₁ was the major component. As shown in Figure 14, the percentage of A₁ varied considerably from one subject to the next but the percentage of A₁ formed from either 1-methyl-¹⁴C- or 2-¹⁴C-administered caffeine was consistent for each subject. The A₂ metabolite was a less polar shoulder on the A₁ HPLC peak in System 1 and was consistently less than 5% of both radiolabeled administered doses.

The isolation scheme directed toward purification of A₁ is shown in Figure 15. Preparative reverse phase HPLC separated A₁ and A₂ from the known caffeine metabolites. Further purification of the A₁ fraction over silica gel, followed by crystallization, afforded homogeneous A₁. This material was then introduced into a high resolution mass spectrometer and the resulting mass spectrum was identical to the mass spectrum of 5-acetylamino-6-amino-3-methyluracil contained in the computer library.

The mass spectral data are presented in Figure 16. The low resolution mass spectrum of A₁ was identical with an authentic standard of 5-acetylamino-6-amino-3-methyluracil which was kindly provided by Professor Wolfgang Pfeleiderer of Konstanz University. High resolution mass spectral data on A₁ confirmed that the molecular ion possessed the same elemental composition as the standard and that the major fragment resulted from loss of the acetyl group by means of the usual ketene loss.

Figure 17 shows that the chromatographic properties of the A₁ metabolite and the standard, were identical.

Figure 18 shows that the ultraviolet absorption maxima of A₁ and the standard shifted with acid and base to the same extent. Also, as additional proof of structure, the 280 over 254 nanometer ratios were identical.

Figure 19 shows the structures of caffeine and the identified A₁ metabolite. Please note the different numbering systems. Although this diaminouracil derivative has long been known to be both a component of human urine and to be associated with caffeine and purine

COMPARISON OF AMOUNT OF A₁ AND A₂ FOUND IN TOTAL URINARY
EXCRETION FOR EACH INDIVIDUAL

SUBJECT	RADIOLABELED CAFFEINE LEG I	% OF DOSE IN URINE				RADIOLABELED CAFFEINE LEG II	% OF DOSE IN URINE			
		TOTAL (0-48 HR)	A ₁	A ₂	SUM		TOTAL (0-48 HR)	A ₁	A ₂	SUM
1	2-RING	84	12.0	2.3	14.3	1-METHYL	70	13.0	1.4	14.4
2	2-RING	76	7.1	2.5	9.6	1-METHYL	74	9.0	2.3	11.3
3	2-RING	87	18.1	2.8	20.9	1-METHYL	65	12.1	1.8	13.9
4	2-RING	90	21.7	5.1	26.8	1-METHYL	77	19.2	5.4	24.6
5	1-METHYL	75	32.9	4.3	37.2	2-RING	91	34.9	4.6	39.5
6	1-METHYL	70	11.9	2.3	14.2	2-RING	89	14.1	1.9	16.0
7	1-METHYL	73	14.6	2.5	17.1	2-RING	84	15.6	2.5	18.1
8	1-METHYL	76	24.5	4.3	28.8	2-RING	82	22.3	3.4	25.7

FIGURE 14

levels in the diet, this is the first study to establish caffeine as the primary source for this compound, as evidenced by the fact that the specific activities of the isolated metabolite and of the administered caffeine were the same. The A₁ metabolite may be produced from the as yet unidentified A₂ metabolite. Preliminary chromatographic and electrophoretic evidence suggest that A₂ is converted to A₁. Future work is directed at confirming whether or not the A₂ conversion product is in fact 5-acetylamino-6-amino-3-methyluracil or another compound with similar chromatographic properties.

In conclusion, we have administered radiolabeled caffeine to human volunteers and quantitated the metabolism of that caffeine by analyzing serum, saliva, CO₂, feces, and urine for either total radiolabeled equivalents, caffeine concentrations or for the metabolites arising from the original radiolabeled doses. For the first time we have characterized greater than 95% of the human urinary metabolites of caffeine, and identified 5-acetylamino-6-amino-3-methyluracil in the urine of subjects in quantities ranging from 7-35% of the administered radiolabeled caffeine dose.

CAFFEINE METABOLITE ISOLATION SCHEME

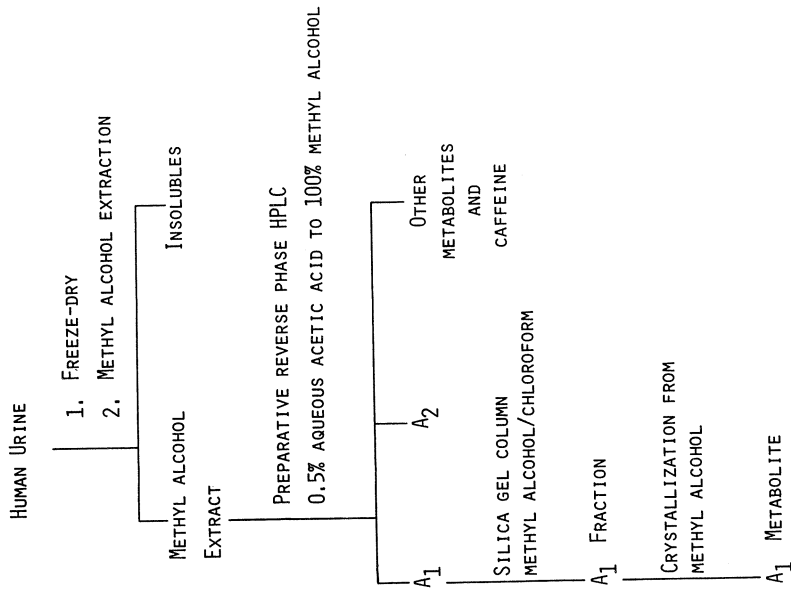

FIGURE 15

A-1 METABOLITE AND 5-ACETYLAMINO-6-AMINO-3-METHYLURACIL:

MASS SPECTROMETRIC DATA

LOW RESOLUTION ELECTRON IMPACT MASS SPECTRA OF BOTH COMPOUNDS IDENTICAL.

M/E 198 (MOLECULAR ION), 156, 98 (MINOR), 71, 43, 28

HIGH RESOLUTION MASS SPECTRAL DATA ON A-1.

M/E ELEMENTAL COMPOSITION

198.0698 C₇H₁₀N₄O₃

156.0646 C₅H₈N₄O₂ LOSS OF C₂H₂O
42 MASS UNITS, KETENE

FIGURE 16

CHROMATOGRAPHIC PROPERTIES OF A-1 METABOLITE AND
5-ACETYLAMINO-6-AMINO-3-METHYLURACIL

<u>THIN-LAYER-CHROMATOGRAPHY</u>	<u>A-1</u> <u>R_F</u>	<u>STANDARD</u> <u>R_F</u>
SILICA GEL PLATES		
CHLOROFORM:METHYL ALCOHOL:WATER (60:80:10)	0.64	0.64
ACETIC ACID:METHYLENE CHLORIDE: CHLOROFORM:WATER (100:60:90:50), LOWER PHASE	0.14	0.14
CHLOROFORM:METHYL ALCOHOL (4:1)	0.14	0.14
CELLULOSE PLATES		
T-BUTYL ALCOHOL:METHYL ETHYL KETONE:WATER:FORMIC ACID (44:44:11:0.26)	0.25	0.25
<u>HIGH PERFORMANCE LIQUID CHROMATOGRAPHY</u>	<u>A-1</u> <u>R_T</u>	<u>STANDARD</u> <u>R_T</u>
C ₁₈ μ BONDAPAK COLUMN 0.5% ACETIC ACID/WATER (2ML/MIN FLOW RATE)	2 MIN	2 MIN
<u>ELECTROPHORESIS</u>	<u>MIGRATION DIRECTION AND DISTANCE</u>	
0.03 M BORATE BUFFER, pH 9.2, 3000 VOLTS FOR ONE HOUR	Co-CHROMATOGRAPH TOWARD ANODE, SEVEN CENTIMETERS	

FIGURE 17

A-1 METABOLITE AND 5-ACETYLAMINO-6-AMINO-3-METHYLURACIL:
ULTRAVIOLET ABSORPTION DATA

	<u>WAVELENGTH MAXIMA (NM) IN</u>			
	<u>WATER</u>	<u>ACID(HCL)</u>	<u>BASE(NAOH)</u>	<u>$\frac{280}{254}$ RATIO¹</u>
A ₁ METABOLITE	263	262	264	0.18
STANDARD	263	262	264	0.18

¹ DETERMINED BY HPLC-UV DETECTION

FIGURE 18

STRUCTURE OF A-1

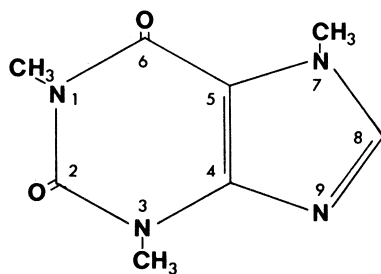

CAFFEINE

1,3,7-TRIMETHYLXANTHINE

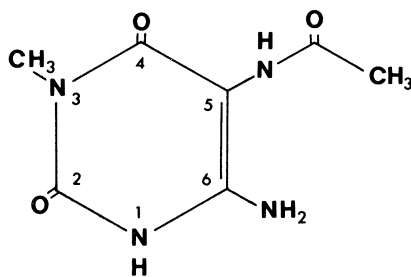

A-1 METABOLITE

5-ACETYLAMINO-6-AMINO-3-METHYLURACIL

FIGURE 19

SUMMARY OF RESULTS

- 1) ACCOUNTED FOR APPROXIMATELY 90% OF THE ADMINISTERED DOSE OF RADIOLABELED CAFFEINE.
- 2) IDENTIFIED GREATER THAN 95% OF THE URINARY RADIOACTIVITY AS SPECIFIC METABOLITES.
- 3) IDENTIFIED 5-ACETYLAMINO-6-AMINO-3-METHYLURACIL IN THE URINE OF SUBJECTS IN QUANTITIES RANGING FROM 7-35% OF THE ADMINISTERED RADIOLABELED CAFFEINE DOSE.

CAFFEINE METABOLISM IN HUMAN SUBJECTS



M. J.
Arnaud

M. J. ARNAUD, C. WELSCH

Nestlé Research Department

CH-1814 La Tour-de-Peilz, Switzerland

1. INTRODUCTION

Since the first experiments performed by CORNISH in 1954 (1), it is well known and often confirmed that in man, no more than 1 % of the ingested caffeine is excreted unchanged in the urine. Thus caffeine must be intensively metabolized to give more polar compounds finally excreted in the urine and the feces.

In the rat it was possible to identify the most important metabolites using radiolabeled caffeine (2, 3). However, too many metabolites were produced by the multiple alternative pathways of caffeine metabolism that some derivatives amounting to 5 % or less of the total urine radioactivity were not identified (3). More accurate quantitative results were obtained and new metabolites were identified by the administration of labeled dimethylxanthine: theobromine (4), paraxanthine (5, 6) and theophylline (7), their metabolic pathways being not so complex compared to caffeine.

Using total urine of volunteers fed radiolabeled caffeine (8) we quantified the metabolites excreted in urine and produced in a first step from caffeine (Fig. 1). These metabolites are the trimethyluric acid produced by a C-8 oxidation, the 6-amino-5-[N-formylmethylamino] 1,3-dimethyluracil produced after the hydration of the 8-9 double bond of the imidazole ring and finally the dimethylxanthines produced by the demethylation of the 1-methyl (theobromine), the 3-methyl (paraxanthine) and the 7-methyl (theophylline). The pathways involving no demethylation with unchanged caffeine amounted in human urine from only 4 to 5 % of the dose administered in contrast with 42 % in the rat (3) where trimethylallantoin was an additional metabolite not found in human (8). Probably other trimethyl derivatives are not yet identified, like the sulphur-containing derivatives of caffeine reported in the rat, the mouse, the rabbit and the horse by Kamei et al. (9), but they must be quantitatively minor metabolites both in man and the animal.

Thus about 95 % of the caffeine metabolism in man proceed through a first demethylation giving a dimethylxanthine. In order to know the relative importance of each of the three demethylation pathways in man and to obtain a complete quantitative pathway of caffeine without the use of labeled compounds, two experiments were undertaken.

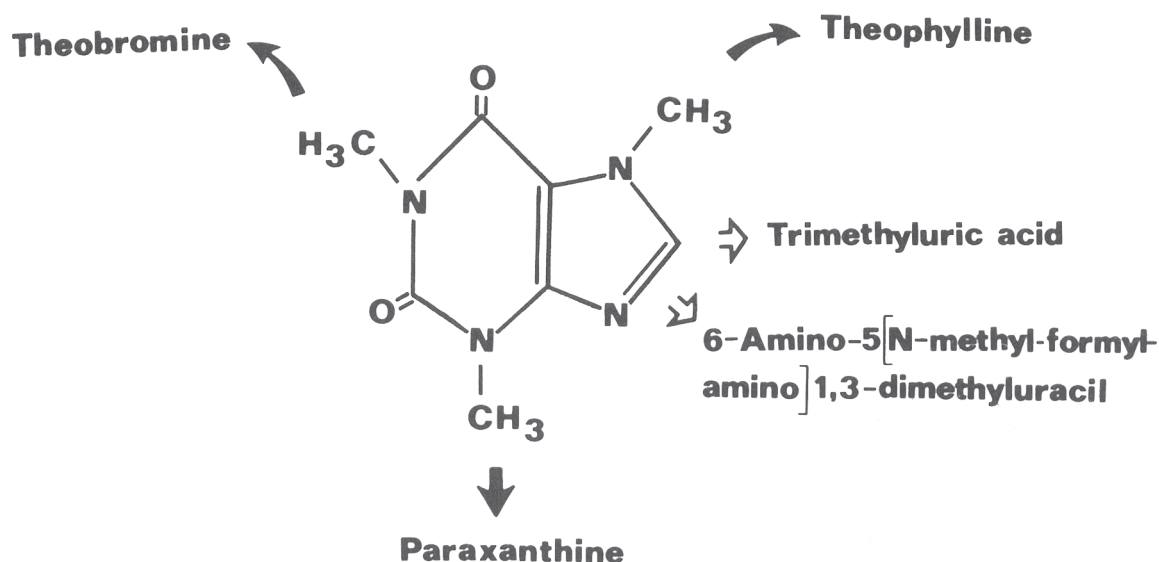

Figure 1

Identified metabolites produced directly from caffeine. The two pathways involving no demethylation amounted to 38 % of the caffeine administered, excreted in rat's urine and only to a maximum of 4 % in the urine of man.

In a first study we have analysed the plasma concentrations of each dimethylxanthine after caffeine administration. As these concentrations are dependent on the urinary excretion of the dimethylxanthine and also on their own metabolism, in a second experiment each dimethylxanthine was administered separately to volunteers and the metabolites of paraxanthine, theobromine and theophylline were quantified in the urine. From these results, each demethylation pathway can be quantified with the hypothesis that the quantitative results are similar when the dimethylxanthines are given orally or when they are produced in the liver from caffeine.

2. EXPERIMENTAL PROTOCOL AND CHEMICALS:

The first experiment was designed to show the effect of caffeine on the energy substrate utilization after a glucose load and during a physical exercise performed on a bicycle ergometer (10). Indirect calorimetry was performed on volunteers who had fasted overnight. They received orally 100 g of maize glucose and 30 minutes afterwards

Caffeine	94 ± 1.5 %
Theophylline	71 ± 2 %
Theobromine	90 ± 3.5 %
Paraxanthine	74 ± 2.5 %
Ethyl-Theophylline	68 ± 2 %

Figure 2

Extraction recovery of the methylxanthines from human plasma. The extraction was performed with the solvent system chloroform-isopropanol (95:5,v/v). Mean ± SEM.

ingested caffeine at a dose of 8 mg/kg. Blood samplings were obtained at the glucose load, 15 min, 30 min, 1 h, 1 h30, 2 h, 2 h30, 3 h, 3 h30, 3 h45 and 4 h after caffeine administration. Ethyl-theophylline was added to each plasma samples as internal standard and caffeine, theophylline, theobromine and paraxanthine were extracted with chloroform-isopropanol (95:5,v/v). The recovery of the extraction is shown in the Fig. 2.

All the dimethylxanthines and caffeine were separated by high pressure liquid chromatography (HPLC) on a Lichrosorb Si-60 column with the solvent system: chloroform-isopropanol-acetic acid (92:7:1,v/v)(11). Quantification was obtained by the integration of the peaks recorded in ultraviolet at 270 nm using a HP 3354. On the Fig. 3 are shown the chromatographic profile of the standards and an extract of a plasma sample.

HPLC: HUMAN EXTRACTS of PLASMA

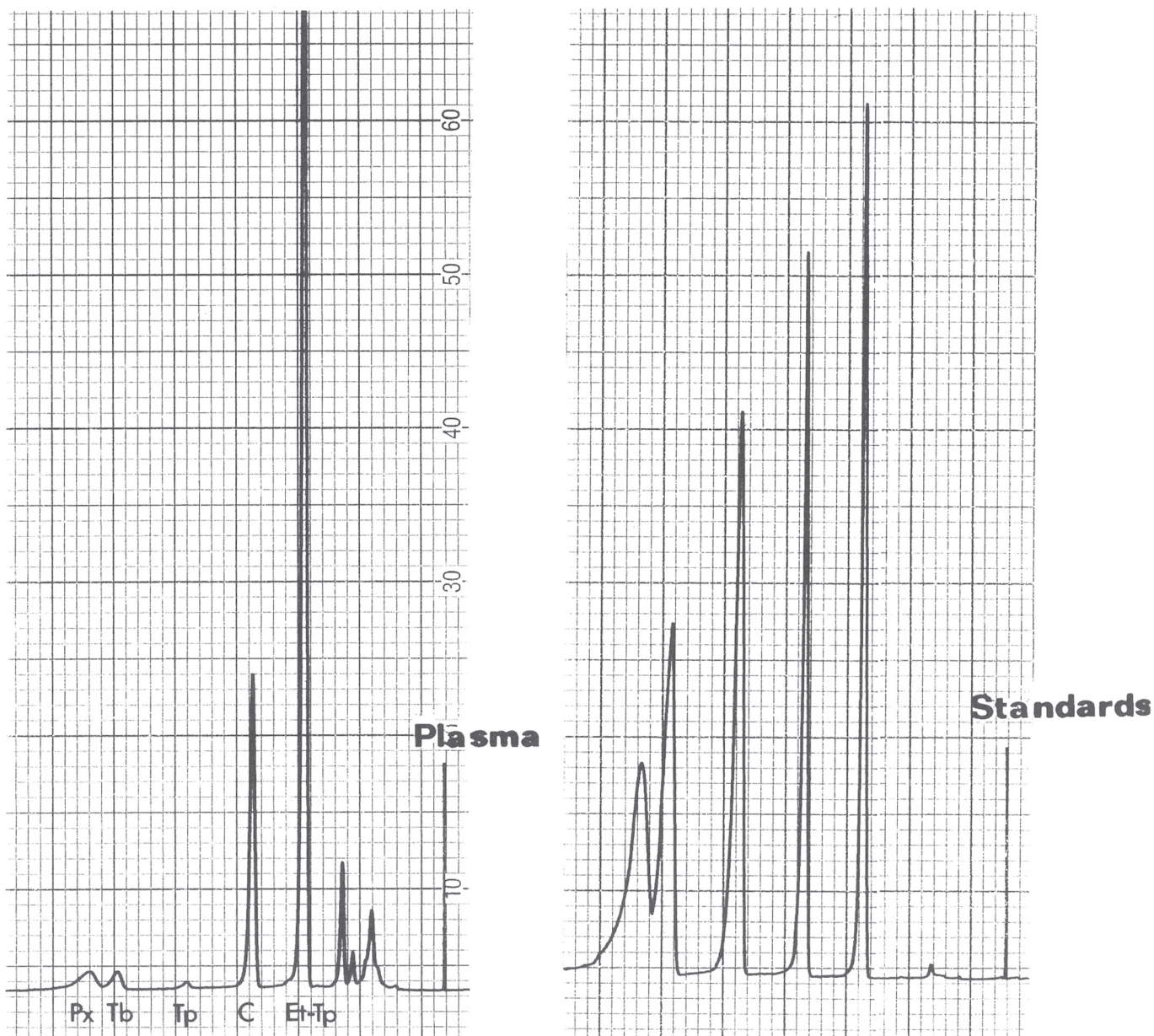

Figure 3

Chromatographic profiles of standards and an human plasma extract, obtained in ultraviolet (270 nm) on a Si-60 column with the solvent: chloroform-isopropanol-acetic acid (92:7:1,v/v). Ethyl-theophylline (Et-Tp), caffeine (C), theophylline (Tp), theobromine (Tb) and paraxanthine (Px) are well separated.

In a second experiment, 6 non-smoking volunteers were asked to take no food and drinks containing caffeine, theobromine and theophylline: coffee, tea, chocolate, soft drinks and drugs containing caffeine, during one week. One subject was allowed to drink instant decaffeinated coffee and 7 days after this diet, dimethylxanthines and their metabolites were detected in quantities which have no effect on the quantitative data. The subjects received orally paraxanthine dissolved in hot milk sweetened with sugar, at a dose of 4 mg/kg. Urine samples were collected after 3, 6, 24 and 48 hours. Then theophylline was ingested and finally theobromine at the same dose and following the same experimental protocol. Quantitatively, the 1-methyl metabolites of paraxanthine collected after 48 hours were shown to have no influence on the results of theophylline metabolites. In the same way the 3-methyl metabolites of theophylline excreted after 48 hours urine collection do not interfere significantly with the metabolites of theobromine.

The urine were purified on a Sep-Pack (Waters) and analysed by HPLC (C-18 reverse phase column). The metabolites were detected and quantified in ultraviolet at 270 nm. A gradient from 1.5 % to 7.5 % acetonitrile in 0.5 % acetic acid was used, this technique was previously established by A. Aldridge.

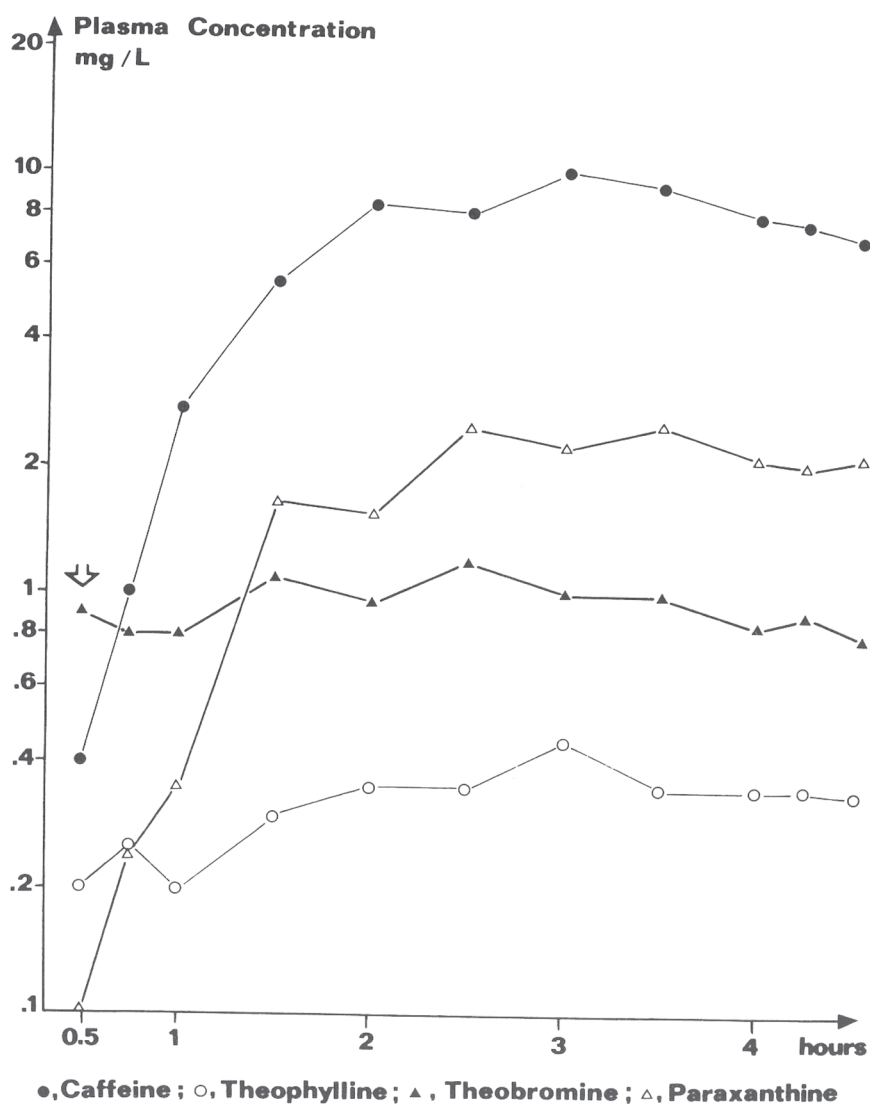

Figure 4

Caffeine and dimethylxanthines plasma concentration found in human after an oral dose of caffeine of 8 mg/kg body weight.

Caffeine, trimethyluric acid, paraxanthine, 1-methylxanthine, 7-methylxanthine, 1,7-dimethyluric acid, 3,7-dimethyluric acid, 1,3-dimethyluric acid, 3-methyluric acid and 7-methyluric acid were obtained from Fluka AG. Theophylline and theobromine (ICN Pharmaceuticals), 3-methylxanthine (Cyclo Chemicals), 1-methyluric acid (Adams Chemicals) were also used as standards. The 6-amino-5-[N-formylmethylamino] 1,3-dimethyluracil, 6-amino-5-[N-formylmethylamino] 1-methyluracil, the 6-amino-5-[N-formylmethylamino] 3-methyluracil, the 6-amino-5-[N-formylamino] 3-methyluracil and the 5-acetylamino-6-amino-3-methyluracil were synthesized by the laboratory of organic synthesis in our Research Department (Dr. G. Philipposian).

3. RESULTS

Before caffeine administration to the subjects fasted overnight, but not submitted to a methylxanthine free diet, significant amounts of caffeine (0.4 ± 0.1 mg/l), theobromine (0.8 mg/l), theophylline (0.2 mg/l) and paraxanthine (0.1 mg/l) were found in all the plasma samples. After caffeine administration (Fig. 4), caffeine plasma concentration increases to reach a maximum of 9.8 ± 0.2 mg/l.

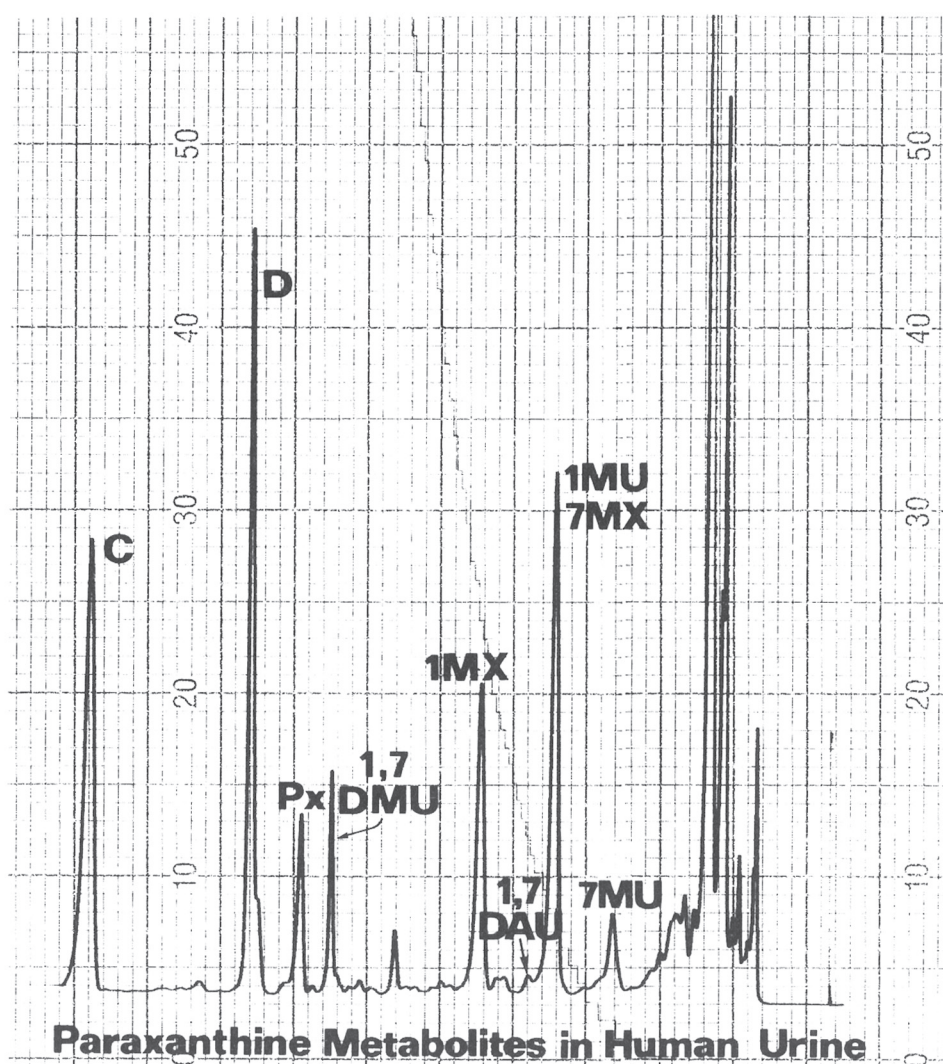

Figure 5

Chromatographic ultraviolet absorption profile of human urine after administration of a 4 mg/kg dose of paraxanthine. The identified metabolites were unchanged paraxanthine (Px), 1,7-dimethyluric acid (1,7-DMU), 1-methylxanthine (1 MX) and 6-amino-5-[N-formylmethylamino] 3-methyluracil (1,7-DAU). The 7-methylxanthine (7-MX) was separated from 1-methyluric acid (1-MU) with an other chromatographic system. The 7-methyluric acid (7-MU), the 6-amino-5-[N-formylamino] 3-methyluracil and the 5-acetylamino-6-amino-3-methyluracil were not separated from urinary constituents and thus were not quantified or identified.

A small increase of theobromine and theophylline plasma concentrations were observed with a maximum of 1.2 ± 0.2 mg/l and 0.4 ± 0.1 mg/l respectively. Paraxanthine was separated with the HPLC system used from the other dimethylxanthines and exhibited the most important increase with maximum concentration of 2.7 ± 0.2 mg/l. The curves observed for caffeine and paraxanthine are parallel.

The chromatographic separation and identification of 9 possible metabolites of paraxanthine was studied in the urine, Fig. 5. Paraxanthine, 1,7-dimethyluric acid and 1-methylxanthine were easily identified. On HPLC, the 6-amino-5-[N-formylmethylamino] 3-methyluracil is separated into two peaks. The first cochromatographed with urinary constituents and we can quantify this metabolite with the second peak eluted after the unseparated 7-methylxanthine and 1-methyluric acid. These two metabolites have been quantified after urine extraction and chromatography on a silica column.

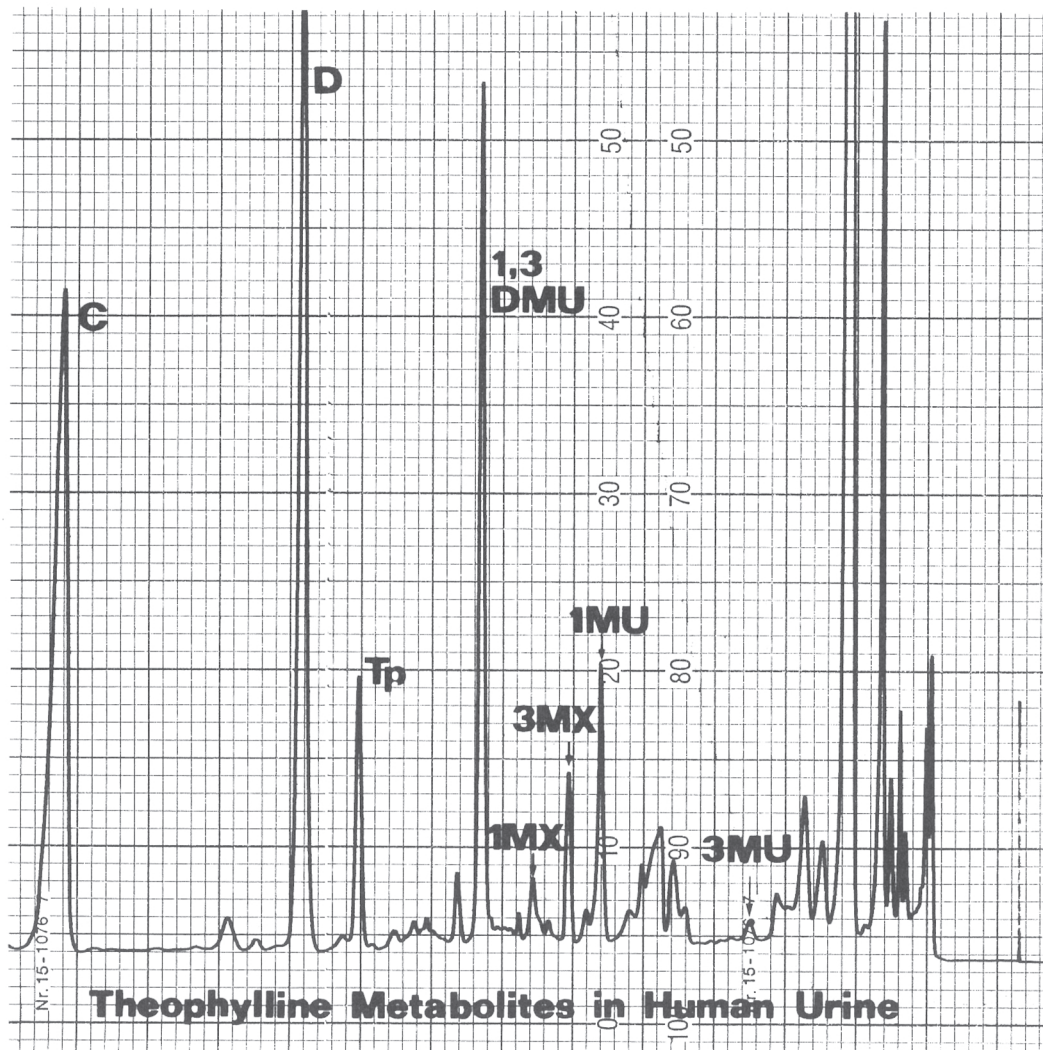

Figure 6

Chromatographic profile of human urine after theophylline oral administration (4 mg/kg). The metabolites identified in addition to theophylline (Tp) were 1,3-dimethyluric acid (1,3-DMU), 1-methylxanthine (1-MX), 3-methylxanthine (3-MX), 1-methyluric acid (1-MU) and 3-methyluric acid (3-MU). Diphylline (D) was used as internal standard and caffeine (C) as reference for chromatographic retention time correction.

The 7-methyluric acid was not resolved from urinary constituents and was not quantified. The 6-amino-5-[N-formylamino] 3-methyluracil and the 5-acetylamino-6-amino-3-methyluracil were also not resolved from urinary constituents and cannot be identified in human urine using these chromatographic conditions.

In the Fig. 6 are shown the 6 theophylline metabolites found in human urine. All these compounds were well separated and the 6-amino-5-[N-formylamino] 1,3-dimethyluracil was not found both in human and rat urine.

The Fig. 7 shows the theobromine metabolites observed. In this case, the 3-methyluric acid was not separated from the second peak of the 6-amino-5[N-formylmethylamino] 1-methyluracil. All the 5 other metabolites were well separated and the 3-methyluric acid seemed to be a minor compound because the second peak of the uracil derivative in urine was not increased compared to the first peak. All these results are presented in the quantitative caffeine metabolic pathway shown in the Fig. 8.

For the 11 metabolites identified in human after dimethylxanthine administration, we calculated their amount after caffeine administration with the hypothesis that the pathways are not modified when caffeine or dimethylxanthines are administered. These quantitative results are presented for the 17 metabolites identified. (Fig. 9)

From the quantitative data we have also been able to calculate the quantitative importance of the three dimethylxanthines pathways in man (Fig. 10, a) and the quantitative importance of total demethylation of caffeine for each methyl group. (Fig. 10, b)

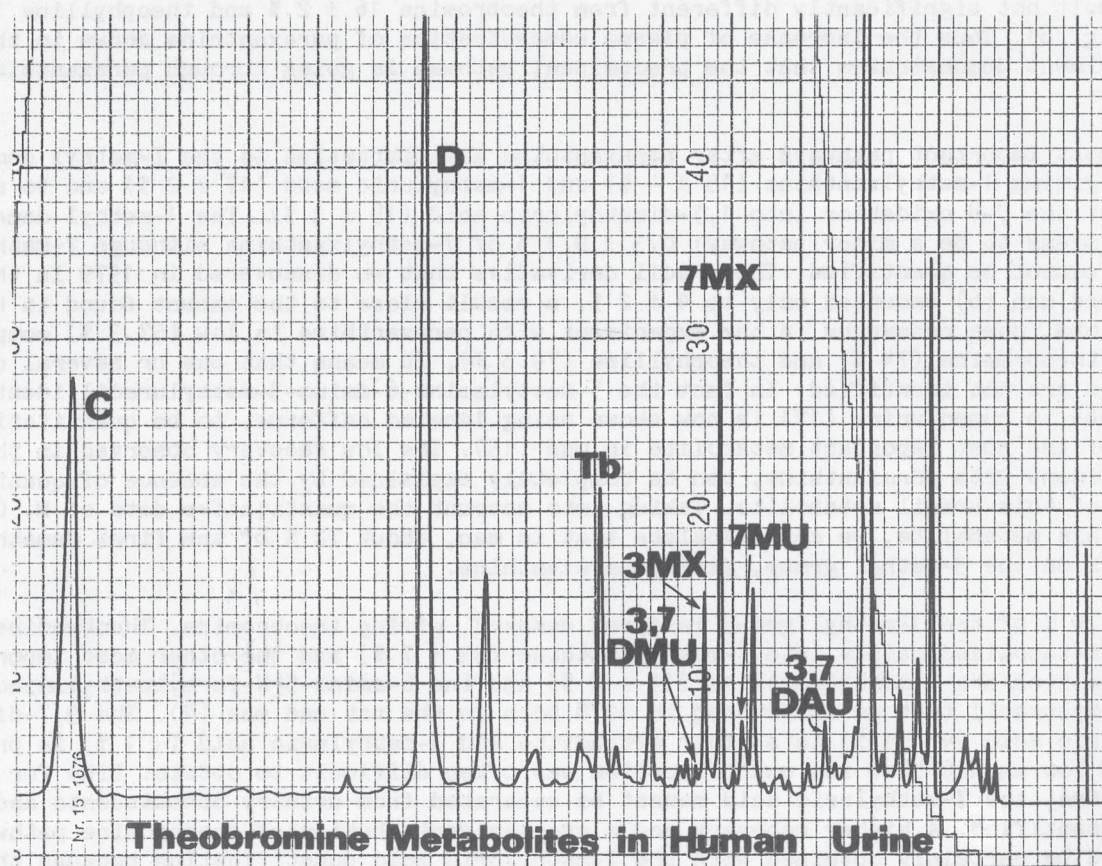

Figure 7

Chromatographic profile of human urine after theobromine oral administration (4mg/kg). Theobromine (Tb), 3,7-dimethyluric acid (3,7-DMU), 3-methylxanthine (3-MX), 7-methylxanthine (7-MX), 7-methyluric acid (7-MU) and 6-amino-5-[N-formylmethylamino] 1-methyluracil (3,7 DAU) were identified. The 3-methyluric acid (3-MU) is not separated from the second peak of the uracil derivative.

4. DISCUSSION

If we compare the kinetic of caffeine in the plasma with the results already published, a dose of 8 mg/kg must produce a plasma concentration higher than 10 mg/l, the peak is normally attained within one hour and the concentration must then decrease more rapidly. We explained this delayed kinetic by the effect of the glucose load on the gastric emptying. We do not know, however, if the physical exercise may have an effect on this kinetic.

The production in the human plasma of the three dimethylxanthines from caffeine is reported for the first time. Previously Sved et al. (12) published the production of theophylline from caffeine. In the rat, Welch and al. (13) showed the kinetic in plasma of the three dimethylxanthines. Paraxanthine, theophylline and theobromine concentrations were found in decreasing amount but very close one to the others. The most recent works on children (14), man (15) and dogs (16) cumulated theophylline and paraxanthine because reverse phase HPLC was used. In man, it was thus not demonstrated that the increased concentration of these dimethylxanthines in the plasma was produced essentially by paraxanthine.

Thus the first 3-methyl demethylation appeared to be the most important pathway in man. The second experiment was particularly important in order to demonstrate that the increase of paraxanthine plasma concentration was not produced by its lack of metabolism or by its lower urinary excretion.

After paraxanthine administration only 10 ± 4 % of this compound was excreted unchanged, a result not significantly different from theobromine 16 ± 2 % and theophylline 10 ± 3 % (Fig. 8). Thus the increase of plasma concentration of paraxanthine shown in the first experiment demonstrates that the predominant pathway is going through paraxanthine in man.

The most important pathways after paraxanthine administration is the 7-methyl demethylation giving 1-methylxanthine (15 ± 4 %) and 1-methyluric acid (17 ± 2 %) and to a lower extent the C-8 oxidation into 1,7-dimethyluric acid (15 ± 3 %). The 1-methyl demethylation seems to be a minor pathway: 0.3 ± 0.1 % of 7-methylxanthine although 7-methyluric acid cannot be quantified. The uracil derivative that we discovered in 1979 in the rat (5) and man (6) amounted only to 4 ± 2 %, a result close to the amount found in the rat. The total dose recovered in the experiment with paraxanthine is low (57.3 %) compared with theobromine (74 %) and theophylline (79.5 %). It means that one or several compounds are not identified. In fact the 5-acetylamino-6-amino-3-methyluracil identified in 1964 in human urine (17) is now shown using labeled caffeine, to be quantitatively one of the most important metabolite in man (15). The low recovery observed in this experiment with paraxanthine, can be completely explained by the absence of quantification of this uracil metabolite. Taking into account the quantitative data of M. Callahan for this metabolite, we can calculate that in man, about 72 % of the first demethylation occurs on the 3-methyl group, giving paraxanthine.

Only 20 % of the 1-methyl group is first removed, giving theobromine. Theobromine is then metabolized mainly into 7-methylxanthine (33 ± 7 %) and the other most important metabolites are 3-methylxanthine (11 ± 2 %) and the 6-amino-5[N-formylmethylamino] 1-methyluracil that we discovered in 1978 both in the rat and man (4). The 3,7-dimethyluric acid (4 ± 1 %) is a minor metabolite and 3-methyluric acid (< 1 %) is present in so low amount that its quantification was often difficult to obtain. Like for paraxanthine, the 7-methyluric acid cannot be separated from urinary constituents and was not quantified. A higher recovery and a greater contribution of theobromine pathway should be certainly obtained with the 7-methyluric acid quantification because the 7-methylxanthine pathway is the most important in the human metabolism of theobromine.

The theophylline pathway is the less important with only 8 % of the first demethylation on the 7-methyl group. The most important metabolite produced from theophylline is the 1,3-dimethyluric acid (37 ± 6 %) and then to a lower extent, the 3-methyl demethylation give a rapidly metabolized 1-methylxanthine (3 ± 1 %), such as a high amount of 1-me-

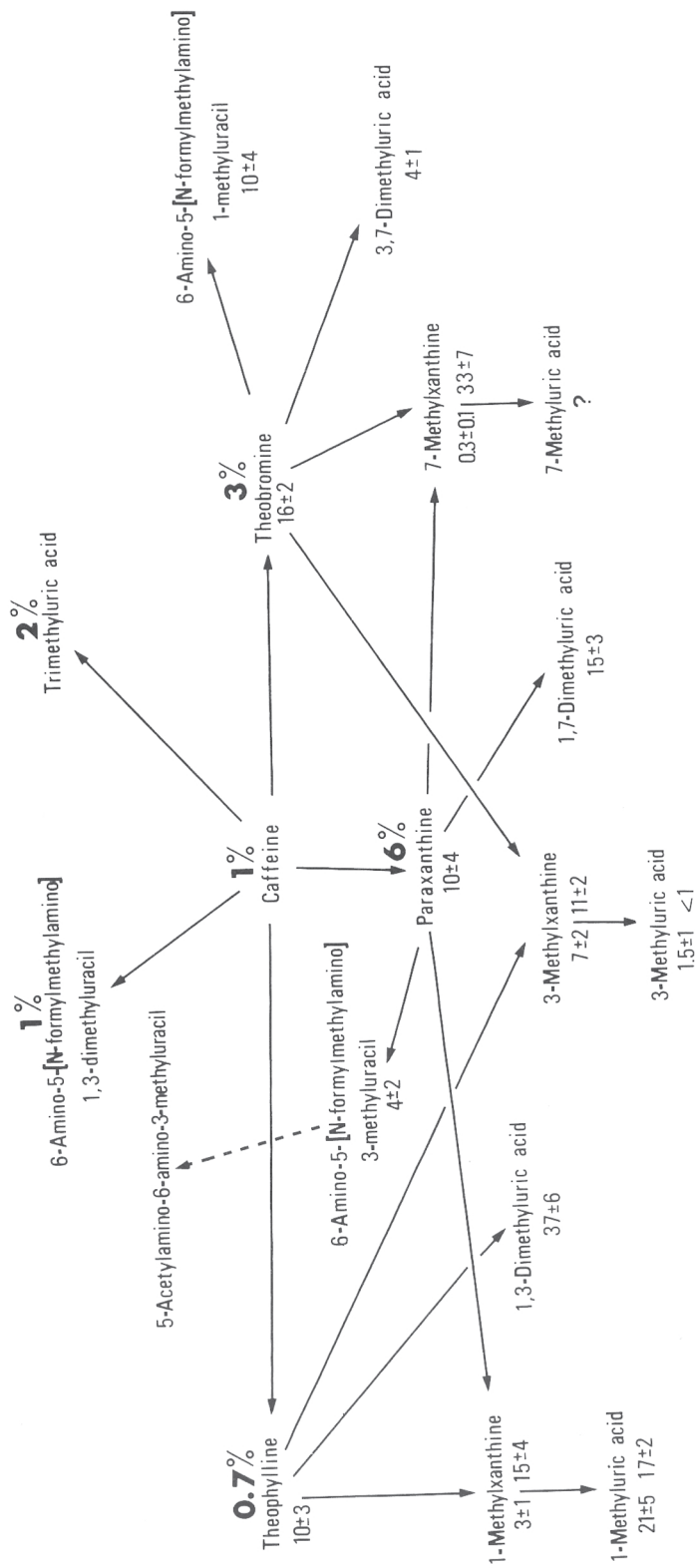

Figure 8

Quantitative metabolic pathway of caffeine in human. The number shown above the metabolites produced directly from caffeine corresponds to the percentage of the dose found in urine. The number shown under all the other metabolites corresponds to the percentage of these compounds found in urine after dimethylxanthine administration. When two numbers are present under a metabolite, it means that this metabolite is produced by two different demethylation pathways. The numbers placed on the right and the left correspond to the pathway (arrow) coming from the right and the left respectively.

thyluric acid is excreted ($21 \pm 5 \%$). The 1-methyl demethylation of theophylline is not important with the 3-methylxanthine ($7 \pm 2 \%$) and the 3-methyluric acid ($1.5 \pm 1 \%$). We can observe that the 1-methyl demethylation is not quantitatively important both for paraxanthine and theophylline. Demethylation of 3-methyl and 7-methyl are predominant while the 3-methyl group is more easily removed from theobromine than the 7-methyl group.

An important difference showing the enzyme specificity linked with the methyl groups is demonstrated for dimethylxanthine C-8 oxidation. Theophylline is very easily oxidized into 1,3-dimethyluric acid ($37 \pm 6 \%$), paraxanthine to a lower extent into 1,7-dimethyluric acid ($15 \pm 3 \%$) and few 3,7-dimethyluric acid ($4 \pm 1 \%$) is produced from theobromine. The presence of the 7-methyl group seems thus to reduce the C-8 oxidation, on the contrary this 7-methyl group is necessary for the hydration of the 8-9 double bond.

The presence of 1-methylxanthine both in the urine of the rat and man account for the importance of the paraxanthine pathway, theophylline giving few 1-methylxanthine ($3 \pm 1 \%$ in human and less than 1% in the rat). The identification by M. Callahan that 1-methylxanthine is quantitatively the most important metabolite in human urine (18%) and also in this study (Fig. 9) 11.7% is a confirmation of the predominance of the paraxanthine pathway in human.

From the 17 metabolites identified in urine we have calculated the total demethylation of the 1-methyl, 3-methyl and 7-methyl group (Fig. 10, b). The 3-methyl demethylation is always the most important process in man (52% of the total methyl groups removed) while the 1-methyl demethylation is reduced to 13% and the 7-methyl demethylation increased to 35% , compared to the results of the first demethylation (Fig. 10, a).

Metabolites	% of the administered dose
Caffeine	1
Trimethyluric acid	2
6-amino-5-[N-formylmethyl amino] 1,3-dimethyluracil	1
paraxanthine	6
theophylline	0.7
theobromine	3
1-methylxanthine	11.7
3-methylxanthine	2.6
7-methylxanthine	6.4
1,7-dimethyluric acid	9
1,3-dimethyluric acid	2.6
3,7-dimethyluric acid	0.8
1-methyluric acid	11.7
3-methyluric acid	0.1
7-methyluric acid	n.d.
6-amino-5-[N-formylmethyl amino] 3-methyluracil	2.4
6-amino-5-[N-formylmethyl amino] 1-methyluracil	1.9
% of the dose identified in urine.	63

Figure 9

Human caffeine metabolites excreted in urine after caffeine, paraxanthine, theophylline and theobromine administration. From the amount of unchanged dimethylxanthines excreted in urine after caffeine administration, the amounts of each dimethylxanthine metabolites were calculated, taking into account the quantitative pathway determined in this study (Fig. 8).

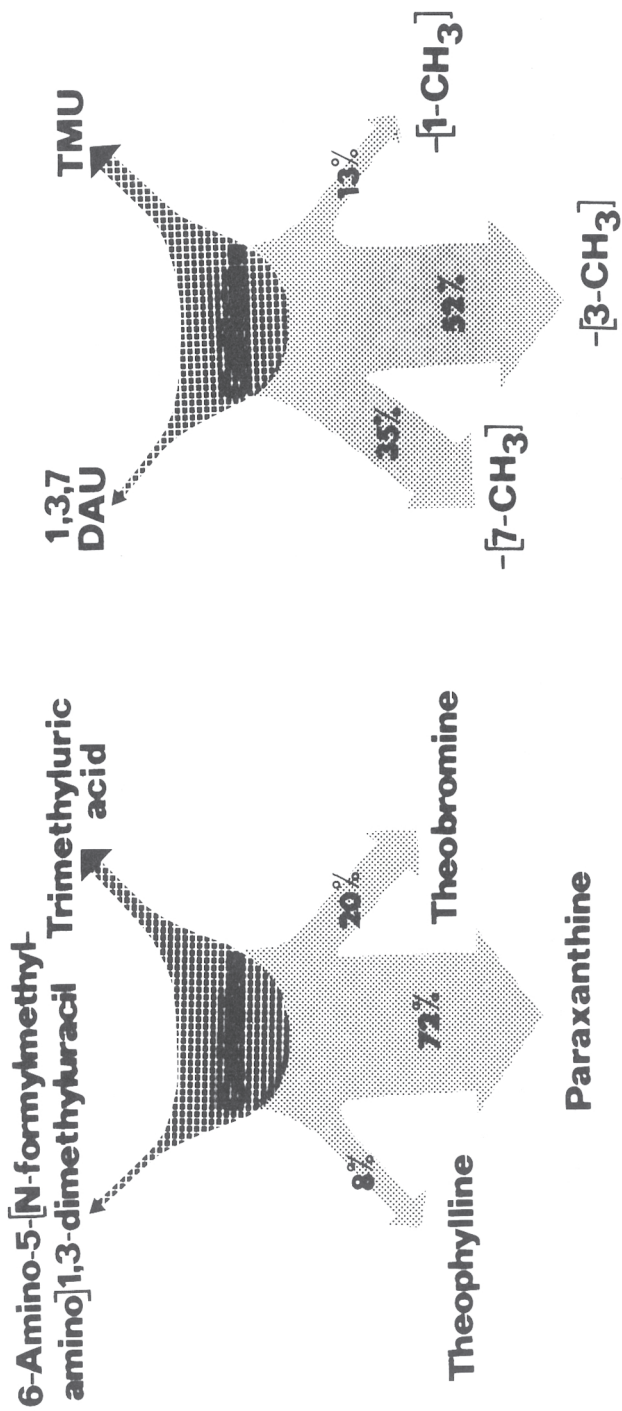

Figure 10

a) Quantitative importance of the three dimethylxanthine pathways in man and b) quantitative importance of total demethylation for the 1-methyl, the 3-methyl and the 7-methyl in caffeine metabolism. These results are calculated from the quantification of caffeine metabolites identified in urine. We take into account the low recovery of the experiment with paraxanthine due mainly to the 5-acetylamino-6-amino-3-methyluracil which was not quantified. The data provided by M. Callahan for this metabolite (15) was used for this calculation.

These results reflect the first 3-methyl demethylation of caffeine into paraxanthine and then in a second step its 7-methyl demethylation. The 3-methyl demethylation is relatively reduced but remained the most important demethylation because both theobromine and theophylline produced from caffeine are mainly demethylated on this methyl group.

To conclude, this work demonstrates the quantitative importance of the paraxanthine pathway in human and we hope that the physiological effects of this molecule would be investigated in the near future, since paraxanthine is completely absent from the chapter dedicated to the methylxanthines in the books of Pharmacology.

In addition, for the first time, the 6-amino-5-[N-formylmethylamino] 1,3-dimethyluracil, the 6-amino-5-[N-formylmethylamino] 1-methyluracil and the 6-amino-5-[N-formylmethylamino] 3-methyluracil have been quantified in human urine. Their relative reduced quantitative importance in human compared to the rat seems to be compensated by the production of the other uracil derivative, the 5-acetylamino-6-amino-3-methyluracil.

5. LITERATURE

1. H. H. CORNISH, Doctoral Dissertation Series, Publication No. 21,165 University Microfilms, Ann. Arbor, Michigan (1956)
2. G. S. RAO, K. L. KHANNA and H. H. CORNISH, *Experientia* 29, 953 (1973)
3. M. J. ARNAUD, *Biochem. Med.* 16, 67 (1976)
4. M. J. ARNAUD and C. WELSCH, *J. Agr. Food Chem.* 27, 3, 524, (1979)
5. M. J. ARNAUD and C. WELSCH, *Experientia* 35, 7, 34 (1979)
6. M. J. ARNAUD, 2nd Int. Caffeine Workshop, Monaco in *Nutrition Reviews* 38, 196 (1980)
7. M. J. ARNAUD and C. WELSCH, *Experientia* 36, 6 (1980)
8. M. J. ARNAUD, (samples provided by M. M CALLAHAN, Arthur D. Little Inc., Cambridge, Massachusetts)
9. K. KAMEI, M. MATSUDA and A. MOMOSE, *Chem. Pharm. Bull.* 23, 683 (1975)
10. P. PAHUD, E. RAVUSSIN, A. THELIN, K. J. ACHESON, M. J. ARNAUD and E. JEQUIER, unpublished results
11. K. K. MIDHA, S. SVED, R. D. HOSSIE and I. J. MCGILVERAY, *Biomed. Mass Spect.* 4, 3, 172 (1977)
12. S. SVED, R. D. HOSSIE and I. J. MCGILVERAY, *Res. Commun. Chem. Pathol. Pharmacol.* 13, 185 (1976)
13. R. M. WELCH, S. Y. HSU and R. L. DE ANGELIS, *Clin. Pharmacol. Ther.* 22, 791 (1977)
14. A. ALDRIDGE, J. V. ARANDA and A. H. NEIMS, *Clin. Pharmacol. Ther.* 25, 447 (1979)
15. M. M. CALLAHAN, R. ROBERTSON, M. LAVIN and D. YESAIR, *Fed. Proc.* 38, 584 (1979)
16. A. ALDRIDGE and H. NEIMS, *Drug Metabolism and Disposition* 7, 378 (1979)
17. K. FINK, W. S. ADAMS and W. PFLEIDERER, *J. Biol. Chem.* 239, 4250 (1964)

THE INFLUENCE OF CAFFEINE AND COFFEE UPON METABOLIC RATE AND SUBSTRATE UTILIZATION IN MAN*

K.J. ACHESON

Institut de Physiologie

Université de Lausanne

7, rue du Bugnon

CH-1011 Lausanne, Suisse

INTRODUCTION

At the beginning of the century Higgins and Means (1) observed that caffeine stimulated the metabolic rate as much as 7 to 23 %. Other workers have also observed this phenomenon as well as its stimulation of plasma free fatty acids (FFA) (2) and catecholamine excretion (3, 4).

These properties of caffeine and the fact that it is habitually consumed in many beverages prompted Miller et al. (5) to propose its use as a thermogenic agent for promoting the loss of body energy in individuals following weight reducing regimens. In fact Reinmann (6) observed low grade fever, insomnia, irritability, anorexia and loss of weight in a waitress who consumed the equivalent of 1.5 to 1.8 g caffeine per day.

In the present series of experiments we investigated the effect of a non-physiological dose of caffeine, 8 mg caffeine/kg body weight, on metabolic rate, substrate utilization and various blood parameters in normal weight individuals. In the following trials we used habitually consumed doses of caffeine (4 mg/kg) given in the form of instant coffee and studied its effect upon the above parameters in both normal weight and obese individuals. Finally we investigated whether the stimulation of metabolic rate by caffeine was synergistic with that of the thermic effect of a meal.

PROTOCOL

The physical characteristics of the subjects who participated in the four experiments are presented in table 1.

On the morning of the test continuous respiratory exchange measurements were made on the fasting subject for 30 minutes to obtain baseline values. The caffeine or coffee was then ingested and measurements were continued for a further 2½ to 3 hours. Blood samples were taken every 30 minutes from -30 minutes until the end of the test.

* The full text of this report has been published in the American Journal of Clinical Nutrition 33: 989-997, 1980

Table 1

	Trial 1 8 mg/kg caffeine	Trial 2 4 mg/kg caffeine as inst. coffee	Trial 3 4 mg/kg caffeine as inst. coffee	4 mg/kg caffeine as instant coffee
Subjects (N)	Control (6)	Control (7)	Obese (6)	Controls (8)
Age (years)	30 ± 5	25 ± 4	30 ± 5	23 ± 1
Height (cm)	171 ± 4	177 ± 6	177 ± 6	170 ± 7
Weight (kg)	67 ± 3	66 ± 3	105 ± 23	61 ± 5
% of ideal weight	110 ± 6	101 ± 6	160 ± 34	105 ± 8
(Mean ± SD)				

METHODS

Metabolic rate was measured using an open-circuit indirect calorimeter, which consists of a transparent ventilated hood which is placed over the subject's head. The air flow through the hood was measured using a linear air flow transducer coupled to a Hewlett Packard pneumotachograph. A sample of the outflowing air was taken and analysed for carbon dioxide and oxygen concentrations. Urine was collected at the end of each test and analysed for urinary nitrogen. Using the above parameters it is possible to calculate metabolic rate and from the non-protein respiratory quotient the oxidation of carbohydrate and fat (7).

Blood samples were taken from an antecubital vein via an indwelling teflon cannula and were analysed for glucose (8), insulin (9), FFA (10) and caffeine (11) concentrations.

RESULTS

Figure 1 illustrates the results obtained in the first experiment in which a gelatin capsule containing either 8 mg caffeine/kg or 500 mg glucose placebo was consumed by the subject.

After caffeine ingestion the metabolic rate (figure 1a) increased in all subjects, reaching a plateau which continued until the end of the test. The placebo caused very little change in metabolic rate during the 3 hour test. When the change in metabolic rate was expressed as a percentage of the baseline value a 16 % increase was observed after caffeine. However, there was a considerable range of individual variation (8 to 30 %).

Substrate utilization (mg/min) is presented in figure 1b. Carbohydrate utilization decreased after both caffeine and placebo ingestion but none of the changes were significantly different to the baseline value. Fat oxidation increased significantly both after caffeine and the placebo ($p < 0.02$). However, it occurred much sooner and to a greater extent after caffeine. Since relations between plasma FFA levels and lipid turnover rates exist (12, 13) the change in plasma FFA observed in our subjects can explain their increased fat utilization after caffeine ingestion. No changes were observed in either blood glucose or plasma insulin levels after either caffeine or the placebo.

Table 2

Plasma Caffeine Concentration mg/l in Trial 1

Subjects	0	30	60	90	120	180
	Min	Min	Min	Min	Min	Min
1	0	2.0	9.2	12.4	18.5	13.9
2	0	20.1	16.8	12.4	11.6	10.7
3	0	11.7	17.1	11.1	10.6	10.0
4	0	10.9	12.6	13.0	18.8	9.8
5	0	7.5	8.7	9.0	7.4	5.8
6	0	25.0	16.4	13.2	12.9	9.7
Mean	0	12.9	13.5	11.9	12.0	10.0
SEM		3.4	1.6	1.6	1.5	1.1

Figure 2 illustrates the change in metabolic rate in normal weight and obese individuals after ingestion of either 4 mg caffeine/kg as instant coffee or an equivalent weight of decaffeinated coffee.

Figure 2

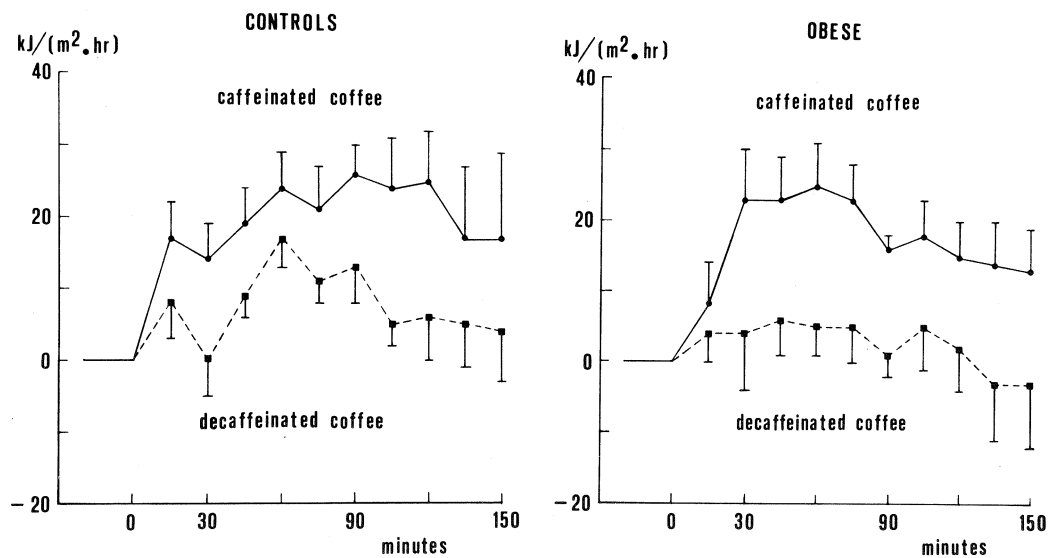

Change in metabolic rate ($\text{kJ}/\text{m}^2 \cdot \text{h}$) in control and obese subjects after ingestion of instant coffee (4 mg/kg caffeine) ●—● and decaffeinated coffee ■---■ (Mean \pm SEM).

Figure 1

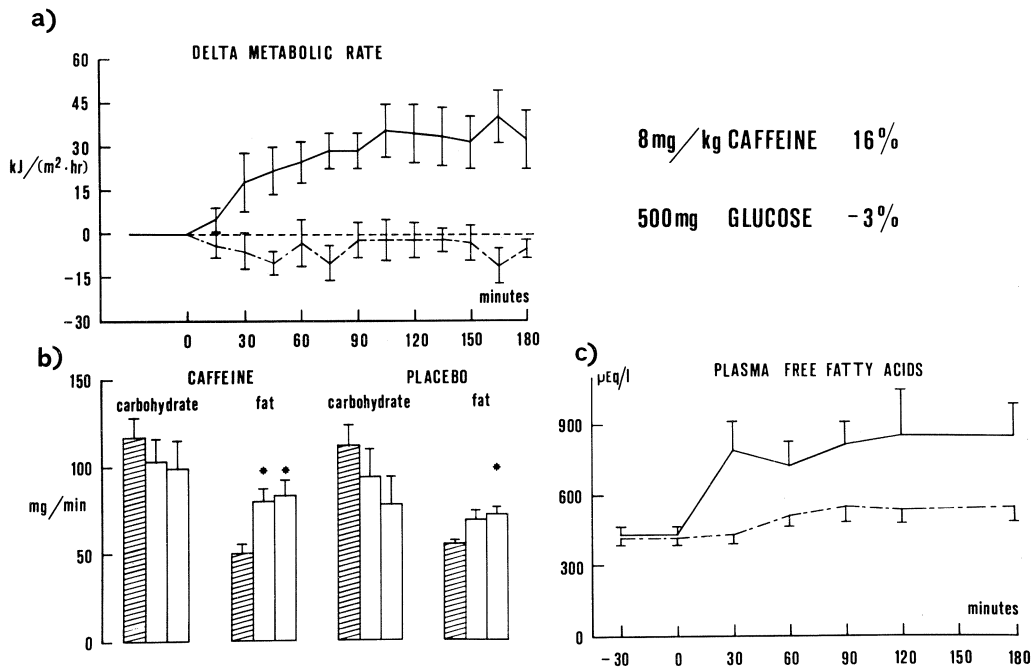



- a) Change in metabolic rate ($\text{kJ/m}^2 \cdot \text{h}$) after ingestion of either 8 mg caffeine/kg ——— or 500 mg glucose - - - - -
- b) Carbohydrate and fat oxidation (mg/min) after either caffeine or placebo ingestion.  represents the baseline values.  represents the last two 30 minute periods of the test.
- c) Change in plasma free fatty acids ($\mu\text{Eq/l}$) after ingestion of either caffeine ——— or the placebo - - - - - (Mean \pm SEM).

Table 2 represents the individual plasma caffeine values obtained during the test. It can be seen that there was a large individual variation in caffeine absorption time. Whilst some of the difference might have been due to the breakdown of the gelatin capsule in which the caffeine was given, it is difficult to explain the difference between subjects 2 and 6 who had peak plasma caffeine values at 30 minutes and subjects 1 and 4 who had peak values only 2 hours after caffeine ingestion. Thus the mean values do not give a very precise picture of the changes in plasma caffeine concentration during the test.

Caffeinated coffee caused significant increases in metabolic rate, above the baseline, in both groups of subjects with a mean increase in metabolic rate of $12 \pm 3\%$ $p < 0.01$ in the controls and $10 \pm 2\%$ $p < 0.05$ in the obese. Decaffeinated coffee also stimulated the metabolic rate in the controls by $5 \pm 2\%$ $p < 0.05$ but had no effect on the obese individuals.

Substrate utilization of the two groups is illustrated in figure 3. Caffeine again caused a slight decrease in carbohydrate utilization and a significant increase in fat oxidation during the last two half hour periods of the test. The changes observed after decaffeinated coffee were not significant.

Figure 3

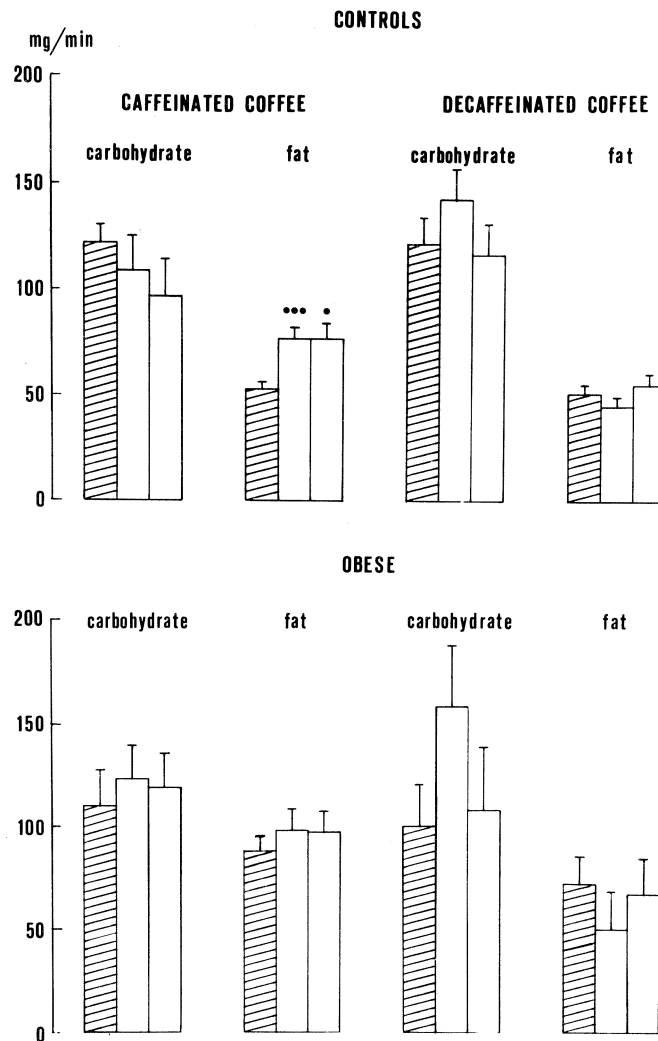

Carbohydrate and fat oxidation (mg/min) of the control and obese subjects after ingestion of caffeinated (4 mg/kg caffeine) and decaffeinated coffee. = baseline, = last two 30 minutes periods of test (Mean \pm SEM).

• $p < 0.05$ ••• $p < 0.01$

In comparison, the obese had a basal carbohydrate utilization lower and a fat oxidation significantly higher than in the controls (Mean \pm SEM of baseline values in caffeinated and decaffeinated coffee experiments 78 ± 8 mg/minute in the obese and 52 ± 3 mg/min) in controls $p < 0.001$). After caffeinated coffee slight changes were observed in both carbohydrate and fat oxidation but they were not significant. The changes observed after decaffeinated coffee were not significant due to large individual variations.

Table 2 summarizes the results obtained on normal weight individuals when either caffeinated (4 mg/kg caffeine) or decaffeinated coffee was taken with a 3080 kJ meal, the energy content of which was provided by 63 % carbohydrate, 27 % fat and 10 % protein.

Table 3

Effect of caffeinated (4 mg/kg caffeine) and decaffeinated coffee on the metabolic rate, thermic effect and substrate utilization after a 3080 kJ meal

	Caffeinated coffee 4 mg/kg caffeine <u>% change</u>		decaffeinated coffee <u>% change</u>
Stimulation of metabolic rate	33 ± 3	$p < 0.01$	22 ± 2
<u>Stimulation of met. rate</u> Energy content of meal x 100			
= thermic effect	9 ± 1	$p < 0.005$	6 ± 0.5
Carbohydrate oxidation (mg/min)	53 ± 7	N.S.	67 ± 16
Fat oxidation (mg/min)	53 ± 7	$p < 0.05$	11 ± 15

During the 3 hours after the meal metabolic rate was stimulated by 22 % with decaffeinated and 33 % with caffeinated coffee and there was a significant difference ($p < 0.01$) between the two tests. When this stimulation of metabolic rate, above the fasting value, was expressed as a percentage of the energy content of the meal, i.e. the thermic effect, a significant difference ($p < 0.005$) was also apparent between caffeinated and decaffeinated coffee.

Carbohydrate utilization increased during both tests due to the large proportion of carbohydrate in the meal. However, after caffeinated coffee carbohydrate utilization decreased more rapidly and fat oxidation increased significantly over both the baseline value and when compared with the decaffeinated coffee trial ($p < 0.05$).

These results show that caffeine consumed as instant coffee in usual daily amounts induced significant increases in metabolic rate, fat mobilization and fat oxidation in normal weight individuals. Whilst a similar stimulation of metabolic rate was observed in the obese, it was not accompanied by increases in either lipolysis or fat oxidation.

The stimulation of metabolic rate by caffeine alone is synergistic with that of a meal.

The possible consequences of these results are that caffeine and coffee do promote the loss of body energy in both normal weight and obese individuals whether it is taken with or between meals. Coffee would appear to stimulate a change of body composition in normal weight individuals by increasing the oxidation of their body fat stores. However, in the obese the loss of body energy is not accompanied by an advantageous decrease in their body fat stores.

REFERENCES

1. HIGGINS, H.L., and J.H. MEANS. The effect of certain drugs on the respiration and gaseous metabolism in normal human subjects. *J. Pharmacol. Exptl. Therap.* 7: 1, 1915.
2. BELLET, S., A. KERSHBAUM and E. M. FINK. Response of free fatty acids to coffee and caffeine. *Metabolism* 17: 702, 1968.
3. BELLET, S., L. ROMAN, O. de CASTRO, K.E. KIM and A. KERSHBAUM. Effect of coffee ingestion on catecholamine release. *Metabolism* 18: 288, 1969.
4. ROBERTSON, D., J.C. FRÖLICH, P.K. CARR, J.T. WATSON, J.W. HOLLIFIELD, D. G. SHAND and J.A. OATES. Effects of caffeine on plasma renin activity, catecholamines and blood pressure. *N. Engl. J. Med.* 298: 181, 1978.
5. MILLER, D.S., M.J. STOCK and J.A. STUART. The effects of caffeine and carnitine on the oxygen consumption of fed and fasted subjects. *Proc. Nutr. Soc.* 33: 28A, 1974.
6. REINMANN, H.A. Caffeinism a cause of long-continued, low-grade fever. *J. Am. Med. Assoc.* 202: 1105, 1967.
7. LUSK, G. *Elements of the Science of Nutrition* (4th ed.). Philadelphia: W.B. Saunders, 1928, p. 65.
8. SLEIN, M.W. D-Glucose determination with hexokinase and glucose-6-phosphate dehydrogenase. In: *Methods of Enzymic Analysis*, edited by H.W. Bergmeyer, New York: Verlag Chemie, Weinheim, Academic Press, 1965, p. 117.
9. HERBERT, V., K.S. LAU, C.W. GOTTLIEB and S.J. BLEICHER. Coated charcoal immunoassay of insulin. *J. Clin. Endocrinol.* 25: 1375, 1965.
10. HEINDEL, J.J., S.W. CUSHMAN and B. JEANRENAUD. Cell associated fatty acid levels and energy-requiring processes in mouse adipocytes. *Am. J. Physiol.* 226: 16, 1974.
11. MILON, H., and J.A. ANTONIOLI. Caffeine determination in rat plasma a comparative study of micromethods. *J. Chromatog.* 162: 223, 1979.
12. BJORNTORP, P., H. BERGMAN, E. VARNAUSKAS and B. LINDHOLM. Lipid mobilization in relation to body composition in man. *Metabolism* 18: 840, 1969.
13. ISSEKUTZ, B., Jr., W.M. BORTZ, H.I. MILLER and P. PAUL. Turnover rate of plasma FFA in humans and in dogs. *Metabol. Clin. Exptl.* 16: 1001, 1967.